



Sistemas de conducción y evacuación de humos
Chimney systems and connecting flue pipes
Conduits de cheminée et systèmes d'évacuation de fumées



Catálogo - Catalog - Catalogue

2018 - 2020

ROS Group, de carácter estrictamente familiar, fue fundado en el año 1867 y desde siempre ha estado especializado en la fabricación de tubos y accesorios de chapa galvanizada, inoxidable y pulida con sistemas de unión tanto tradicionales como modulares de nueva generación.

ROS Group, strictly family-owned, was founded in the year 1867 and has always specialized in the manufacture of pipes and accessories made from galvanized, stainless steel and polished sheet metal with both traditional and contemporary modular joint systems.

ROS Group, à caractère strictement familial, a été fondée en 1867 et qui a toujours été spécialisée dans la fabrication de tuyaux et d'accessoires en tôle galvanisée, inoxydable et polie avec des systèmes d'union autant traditionnels que modulaires de nouvelle génération.



ROS Group en la actualidad está formado por dos empresas; ROS DUCTING S.L.U., cuya planta de producción está ubicada en Sant Jaume de Llierca (Girona), y ROS CHIMNEYS S.L.U., ubicada en El Pla de Santa Maria (Tarragona).

Nuestras instalaciones en ROS DUCTING cuentan con una superficie total de 12.000 m² incluyendo un almacén a 7 niveles con una superficie útil de 30.000 m². Por otra parte, las instalaciones en ROS CHIMNEYS cuentan con una superficie total de 6.000 m² incluyendo un almacén a 6 niveles con una superficie útil de 10.000 m².

Ambas disponen de un amplísimo parque de maquinaria, moderno y con los últimos avances tecnológicos, además de un gran número de utillajes de tecnología propia, a fin de lograr un continuo y alto estándar de calidad, respeto por el medio ambiente y excelentes condiciones de trabajo de sus colaboradores.

ROS Group currently consists of two companies; ROS DUCTING S.L.U., whose production facility is located in Sant Jaume de Llierca (Girona), and ROS CHIMNEYS S.L.U., located in El Pla de Santa Maria (Tarragona).

Our facilities in ROS DUCTING have a total area of 12,000 m² including a warehouse at 7 levels with a useful area of 30,000 m². On the other hand, the facilities at ROS CHIMNEYS have a total area of 6,000 m² including a warehouse at 6 levels with a useful area of 10,000 m².

Both have an extensive, modern machine park with the latest technological advances, as well as a large number of implements of our own design in order to achieve sustained high quality standards, respect for the environment and excellent working conditions of its employees.

ROS Group comprend actuellement deux entreprises; ROS DUCTING S.L.U., dont l'usine de production est située à Sant Jaume de Llierca (Girona), et ROS CHIMNEYS S.L.U., située à El Pla de Santa Maria (Tarragona).

Les installations de ROS DUCTING ont une surface totale de 12.000 m² comprenant un magasin à 7 niveaux avec une surface utile de 30.000 m². D'autre part, les installations de ROS CHIMNEYS ont une surface totale de 6.000 m² incluant un magasin de 6 niveaux avec une surface utile de 10.000 m².

Les deux ont un grand parc de machines modernes dotées des dernières avancées technologiques, ainsi qu'un grand nombre d'outils de technologie propre pour permettre le maintien d'un haut standard de qualité, le respect pour l'environnement et des excellentes conditions de travail de ses employés.





Nuestras Oficinas Técnicas apoyadas por sus Departamentos de I+D ofrecen todo el soporte técnico y asesoramiento necesarios para el diseño y construcción de proyectos adaptados a la medida del cliente.

La acción de nuestros Departamentos Comerciales está basada en alcanzar con nuestros clientes una relación comprometida y estable, estando siempre a su disposición para atenderles personalmente de forma rápida y eficaz.

El servicio esmerado, ágil y eficaz de nuestros Departamentos de Expediciones, con el apoyo de agentes logísticos de categoría contrastada, hace que nuestros clientes reciban puntualmente sus pedidos.

Our Technical Departments assisted by the R&D Departments provide all technical support and assessment for the design and construction of projects adapted to the customer needs.

The action of our Sales Departments staff works on a basis of stable commitment, providing personal, rapid and effective service when and where you need it.

Our Logistics Departments efficiency is supported by a broad category of transport agents to ensure the best and swiftly delivery times to all customers.

Les Bureaux Techniques, renforcé par son Département de R&D, est en mesure d'offrir tout le support technique et toute l'assistance nécessaires à la conception et à la construction de projets adaptés aux besoins du client.

L'action des Départements Commerciaux a pour objectif l'établissement d'une relation stable et engagée avec les clients et d'assurer la disponibilité nécessaire à une réponse personnalisée, efficace et rapide.

Le service soigneux, agile et efficace des Départements d'Expéditions, avec le support d'agents logistiques hautement qualifiés, permettent d'assurer la livraison ponctuelle des commandes.



ROS Group tiene como objetivo la aportación al mercado de un producto con la máxima calidad, con identidad propia, diferente y que ha sido proyectado, desarrollado y certificado íntegramente en nuestras instalaciones, a fin de buscar la plena satisfacción de nuestros clientes, ofreciéndoles en todo momento las soluciones que mejor se adaptan a sus necesidades.

ROS Group has the objective to supply the market with the highest quality product, with its own unique identity, a product which has been planned, developed and certified within our facilities to achieve the satisfaction of our clients by offering solutions adapted to their needs at all times.

ROS Group a pour objectif apporter au marché un produit d'haute qualité, avec une identité propre, différente et qui ait été projeté, développé et certifié dans nos installations, en recherchant la pleine satisfaction de nos clients pour leur offrir en tout moment les solutions qui s'adaptent le mieux à leurs besoins.



ROS Group se considera hoy día como uno de los fabricantes de tubería modular metálica con más prestigio y proyección del mundo, y cuenta con una amplia cartera de clientes tanto de ámbito nacional como internacional, que constituyen una referencia en sus respectivos países.

ROS Group is today one of the most prestigious manufacturers of metallic modular ducting in the world, with a large clientele in both the national and international arena, clients with respected reputations in their respective countries.

ROS Group est aujourd'hui l'un des fabricants de tuyauterie modulaire métallique les plus prestigieux du monde, avec une clientèle large sur la scène nationale et internationale, et à la fois réputée dans leurs pays respectifs.



Los productos fabricados en las empresas de ROS Group se utilizan en un rango muy variado de aplicaciones y sectores, tales como:

- **Extracción de polvo, aire, humos, neblinas y subproductos a escape libre o a filtros y ciclones**
Sistemas de tubería para captación y aspiración para filtración de polvo, vahos, olores y humos contaminantes.
- **Transporte neumático y distribución de sólidos en líneas de producción**
Sistemas de tubería para captación y transporte neumático a baja presión de productos en procesos de fabricación, así como caída gravitacional para el transporte y envasado de productos a granel.
- **Sistemas de calefacción, agua caliente sanitaria y biomasa**
Sistemas de tubería para estufas, calderas y chimeneas de leña, carbón, gasoil, pellet, así como también instalaciones de biomasa y evacuación de aire, humos y gases.
- **Ventilación, climatización y refrigeración de procesos industriales y domésticos**
Sistemas de tubería para impulsión, extracción y evacuación de aire, vapores y humos para la ventilación, climatización y refrigeración de procesos industriales y domésticos.

The products manufactured in ROS Group companies are used in a wide range of applications and sectors, such as:

- **Dust extraction, exhaust air, fumes, oil mist and by-products removal to the open air or to filters and cyclones**
Pipework systems for collection and aspiration of dust, vapors, odors in filtration processes.
- **Pneumatic transport and distribution of bulk solids in manufacturing processes**
Pipework systems for low pressure conveying of products in manufacturing processes, as well as gravitational fall and bulk goods conveying.
- **Heating systems, sanitary hot water and biomass**
Pipework systems for stoves, boilers and fireplaces of firewood, coal, gasoil, pellet, as well as biomass installations and evacuation of air, smoke and gases.
- **Ventilation, air conditioning and refrigeration of industrial and domestic processes**
Pipework systems for impulsion, extraction and evacuation of air, vapors and fumes for ventilation, air conditioning and refrigeration of industrial and domestic processes.

Les produits fabriqués dans les sociétés du groupe ROS sont utilisés dans un large éventail d'applications et de secteurs, tels que:

- **Extraction de poussière, air d'échappement, fumées, brouillard d'huile et des sous-produits à échappement libre ou à conduction à filtres et cyclones**
Systèmes de tuyauterie pour le dépoussiérage et aspiration de vapeurs, d'odeurs et de particules dans les procédés de filtration.
- **Transport pneumatique et distribution de granulés dans les lignes de production**
Systèmes de tuyauterie pour la collecte pneumatique et le transport à basse pression des produits dans les processus de fabrication, ainsi que la chute gravitationnelle pour le transport et l'emballage des produits en vrac.
- **Systèmes de chauffage, eau chaude sanitaire et biomasse**
Systèmes de tuyauterie pour les poêles, les chaudières et les cheminées de bois de chauffage, charbon, diesel, granulés, ainsi que les installations de biomasse et l'évacuation de l'air, des fumées et des gaz.
- **Ventilation, climatisation et refroidissement des processus industriels et domestiques**
Systèmes de tuyauterie pour l'impulsion, l'extraction et l'évacuation de l'air, des vapeurs et des fumées pour la ventilation, la climatisation et le refroidissement des processus industriels et domestiques.



Uso de conductos dependiendo del tipo de combustible utilizado

Pipelines use depending on the type of fuel used

Utilisation de conduits en fonction du type de combustible utilisé

Combustibles Fuels Carburants	Materiales Materials Matériels	Capítulos relacionados Related chapters Chapitres associés
	304 304L 316L 904L VITRI	1 2 4 6 8 9 12 15
	316L 904L PP	1 2 8 9 10 12 13 17
	304 304L 316L 904L VITRI PP	1 2 4 6 8 9 10 12 13 15 17
	304 304L 316L 904L VITRI	1 2 4 6 8 9 12 15
	316L 904L PP	1 2 8 9 10 12 13 17
	316L 904L VITRI PP	1 2 6 8 9 10 12 13 15 17
	316L 904L VITRI	1 2 3 6 8 9 12 15
	316L 904L VITRI	1 2 3 6 7 8 9 12 15
	316L 904L VITRI	1 2 3 6 8 9 12 15
	904L VITRI	6 15

INFOGRAFÍA | INFOGRAPHICS | INFOGRAPHIE

COMBUSTIBLES · FUELS · CARBURANTS

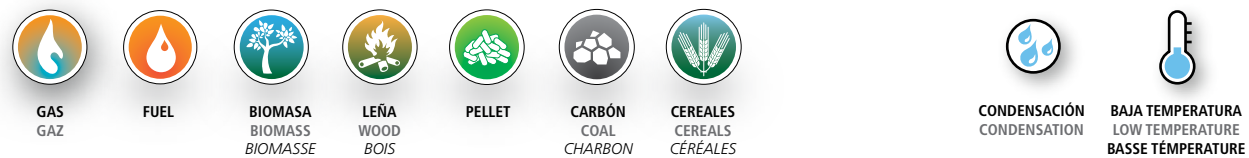

MATERIALES · MATERIALS · MATÉRIELS

Acero inoxidable Stainless steel Acier inoxydable		Vitrificado negro Vitriified black Vitriifié noir		Polipropileno Polypropylene Polypropylène	
AISI 304	1.4301	AISI 304L	1.4307	VITRI	DC01EK AM O
AISI 316L	1.4404	AISI 904L	1.4539	PP	

ÁREAS DE UTILIZACIÓN · AREAS OF USE · DOMAINES D'UTILISATION

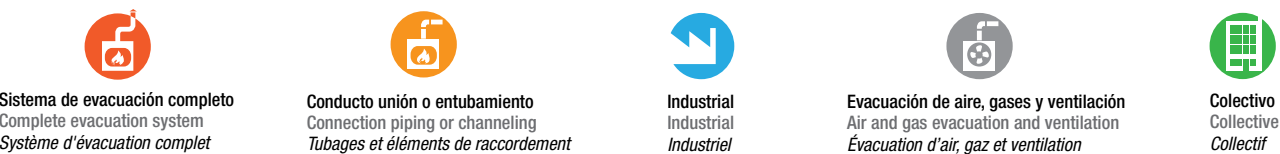

SIGNOS DE NORMATIVAS · REGULATORY SIGNS · MARQUAGES RÉGLEMENTAIRES

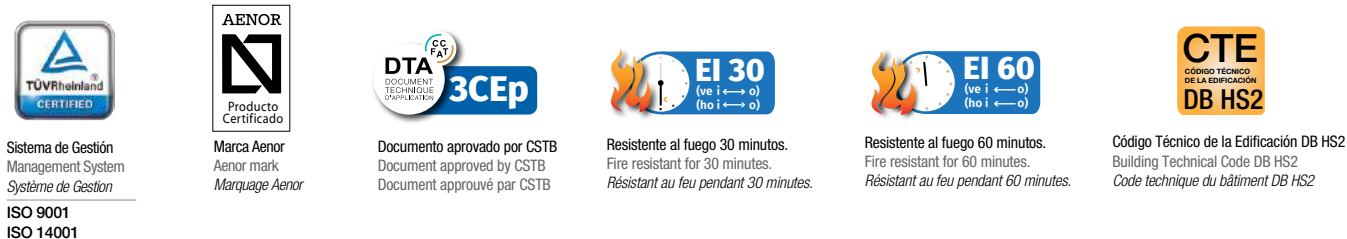

IMPORTANT: Esta información es una referencia general. Cada país tiene su reglamentación específica. Por favor, contacte con nuestro servicio técnico para más información.

SUMARIO · SUMMARY · SOMMAIRE

página / page

1	SIMPLE PARED SINGLE WALL SIMPLE PAROI	10
2	SIMPLE PARED INDUSTRIAL INDUSTRIAL SINGLE WALL SIMPLE PAROI INDUSTRIEL	34
3	SIMPLE PARED NEGRO MATE SINGLE WALL MATT-BLACK SIMPLE PAROI NOIR MAT	46
4	FUMISTERIA INOXIDABLE STAINLESS STEEL CONNECTING FLUE PIPE FUMISTERIE INOXYDABLE	50
5	FUMISTERIA GALVANIZADA GALVANIZED CONNECTING FLUE PIPE FUMISTERIE GALVANISÉ	54
6	FUMISTERIA VITRIFICADA VITREOUS ENAMEL CONNECTING FLUE PIPE FUMISTERIE ÉMAILLÉE	58
7	TUBERÍA PELLET PELLET PIPING TUBAGE POËLE À PELLETS	62
8	DOBLE PARED DOUBLE WALL DOUBLE PAROI	72
9	DOBLE PARED INDUSTRIAL INDUSTRIAL DOUBLE WALL DOUBLE PAROI INDUSTRIEL	94
10	DOBLE PARED COLECTIVO COLLECTIVE DOUBLE WALL DOUBLE PAROI COLLECTIF	104
11	DOBLE PARED EI30 EI60 DOUBLE WALL EI30 EI60 DOUBLE PAROI EI30 EI60	110
12	CONDUCTO CONCÉNTRICO CONCENTRIC PIPING CONDUIT CONCENTRIQUE	126
13	CONDUCTO CONCÉNTRICO COLECTIVO COLLECTIVE CONCENTRIC PIPING CONDUIT CONCENTRIQUE COLLECTIF	134
14	BAJANTE DE DESCARGA DOWNPIPING DUCT CONDUIT DE DESCENTE	142
15	CONDUCTO FLEXIBLE FLEXIBLE PIPING CONDUIT FLEXIBLE	146
16	ACCESORIOS ACCESSORIES ACCESSOIRES	150
17	CONDUCTO DE POLIPROPILENO POLYPROPYLENE PIPING CONDUIT DE POLYPROPYLÈNE	160
18	Información general, condiciones de venta y garantía General information, sales terms and warranty Informations générales, conditions de vente et garantie	164



1
SP



AISI 304
AISI 316L
Ø80-Ø400

SIMPLE PARED | SINGLE WALL | SIMPLE PAROI
Chimenea modular inoxidable con abrazadera de unión.
Modular, stainless steel chimney with connection bracket.
Cheminée modulaire en acier inoxydable avec collier de fixation.

Página | Page
10

2
SPi



AISI 304
AISI 316L
Ø450-Ø700

SIMPLE PARED INDUSTRIAL | INDUSTRIAL SINGLE WALL | SIMPLE PAROI INDUSTRIEL
Chimenea modular inoxidable de uso industrial con abrazadera de unión ancha.
Modular, stainless steel industrial chimney with wide connection bracket.
Cheminée modulaire industriel en acier inoxydable avec collier de fixation large.

Página | Page
34

3
SPN



AISI 316L
Ø80-Ø150

SIMPLE PARED NEGRO MATE | SINGLE WALL MATT-BLACK | SIMPLE PAROI NOIR MAT
Chimenea modular inoxidable lacado en negro mate 600°C con abrazadera de unión.
Modular, 600°C matt-black lacquered, stainless steel chimney with connection bracket.
Cheminée modulaire en acier inoxydable laqué noir mat 600°C avec collier de fixation.
senotherm® 600°

Página | Page
46

4
Fi



AISI 304 2B
Ø80-Ø400

FUMISTERÍA INOXIDABLE | STAINLESS STEEL CONNECTING FLUE PIPE | FUMISTERIE INOXYDABLE
Conducto de unión enchufable en acero inoxidable 2B mate.
Matt, 2B stainless steel plug-in connection piping.
Conduit à raccord enfichable en acier inoxydable mat 2B.

Página | Page
50

5
Fg



GALVA
Ø80-Ø400

FUMISTERÍA GALVANIZADA | GALVANIZED CONNECTING FLUE PIPE | FUMISTERIE GALVANISÉ
Conducto de unión enchufable en acero galvanizado.
Plug-in connection piping in galvanized steel.
Conduit à raccord enfichable en acier galvanisé.

Página | Page
54

6
Fv



VITRI-B
VITRI-M
Ø80-Ø200

FUMISTERÍA VITRIFICADA | VITREOUS ENAMEL CONNECTING FLUE PIPE | FUMISTERIE ÉMAILLÉE
Conducto de unión enchufable en acero vitrificado.
Plug-in connection piping in vitrified steel.
Conduit à raccord enfichable en acier vitrifié.

Página | Page
58

7
TP

TUBERÍA PELLET | PELLET PIPING | TUBAGE POÊLE À PELLETS
Sistemas para conexión de estufas de pellet.
Pellet stove connection systems.
Systèmes de raccordement pour poêle à pellets.

AISI 316L
Ø80-Ø100

SIMPLE PARED | SINGLE WALL | SIMPLE PAROI

VITRI-M
Ø80

SIMPLE PARED "EASY LINE" | SINGLE WALL "EASY LINE" | SIMPLE PAROI "EASY LINE"

AISI 316L
Ø80-Ø100

SIMPLE PARED NEGRO MATE | SINGLE WALL MATT-BLACK | SIMPLE PAROI NOIR MAT

AISI 316L-304
Ø80-Ø100

DOBLE PARED | DOUBLE WALL | DOUBLE PAROI

AISI 316L-304
Ø80/130-Ø100/150

CONDUCTO CONCÉNTRICO | CONCENTRIC PIPING | CONDUIT CONCENTRIQUE

Página | Page
62

8
DP



AISI 304-304
AISI 316L-304
Ø80-Ø350

DOBLE PARED | DOUBLE WALL | DOUBLE PAROI
Chimenea Doble Pared inoxidable aislada con abrazadera de unión clip.
Double Wall insulated, stainless steel chimney with clip-on connection bracket.
Cheminée Double Paroi isolée en acier inoxydable avec collier clip de fixation.

Página | Page
72

9
DPi



AISI 304-304
AISI 316L-304
Ø400-Ø650

DOBLE PARED INDUSTRIAL | INDUSTRIAL DOUBLE WALL | DOUBLE PAROI INDUSTRIEL
Chimenea Doble Pared industrial inoxidable aislada con abrazadera de unión clip.
Double Wall insulated, stainless steel industrial chimney with clip-on connection bracket.
Cheminée Double Paroi industriel isolée en acier inoxydable avec collier clip de fixation.

Página | Page
94

10
DPc



AISI 304-304
AISI 316L-304
Ø130-Ø300

DOBLE PARED COLECTIVO | COLLECTIVE DOUBLE WALL | DOUBLE PAROI COLLECTIF
Chimenea Doble Pared inoxidable aislada con abrazadera de unión clip, para instalación colectiva.
Double Wall stainless steel isolated chimney with clip-on connection bracket, for collective installation.
Cheminée Double Paroi en acier inoxydable isolant avec collier clip de fixation, pour installation collective.

Página | Page
104

11
DPei



AISI 304-304
Ø130-Ø600

DOBLE PARED EI30 EI60 | DOUBLE WALL EI30 EI60 | DOUBLE PAROI EI30 EI60
Conducto Doble Pared inoxidable aislado con abrazadera de unión ancha. Resistente al fuego 30 minutos.
Double Wall insulated, stainless steel piping with wide connection bracket. Fire resistant for 30 minutes.
Conduit Double Paroi isolé en acier inoxydable avec collier de fixation large. Résistant au feu de cheminée pendant 30 minutes.

Página | Page
110

12
CC



AISI 304-304
AISI 316L-304
Ø80/125-Ø130/200

CONDUCTO CONCÉNTRICO | CONCENTRIC PIPING | CONDUIT CONCENTRIQUE
Conducto Doble Pared inoxidable concéntrico con admisión de aire, para instalaciones individuales.
Double Wall concentric, stainless steel piping with air inlet for individual installations.
Conduit Double Paroi concentrique en acier inoxydable avec prise d'air pour installations individuelles.

Página | Page
126

13
CCc



AISI 316L-304
Ø100/150-Ø250/400

CONDUCTO CONCÉNTRICO COLECTIVO | COLLECTIVE CONCENTRIC PIPING | CONDUIT CONCENTRIQUE COLLECTIF
Conducto modular inoxidable concéntrico con admisión de aire, para instalaciones colectivas.
Modular, concentric, stainless steel piping with air inlet, for collective installations.
Conduit modulaire concentrique en acier inoxydable avec prise d'air pour installations collectives.

Página | Page
134

14
BD



AISI 304
AISI 316L
Ø450-Ø600

BAJANTE DE DESCARGA | DOWNPIPING DUCT | CONDUIT DE DESCENTE
Conducto vertical en acero inoxidable para descarga de materiales diversos embolsados.
Stainless steel vertical duct to discharge various bagged materials.
Conduit vertical en acier inoxydable pour décharger divers matériaux ensachés.

Página | Page
142

15
CF

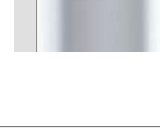

AISI 304-304
AISI 316L-304
AISI 904L-316L
Ø80-Ø300

CONDUCTO FLEXIBLE | FLEXIBLE PIPING | CONDUIT FLEXIBLE
Conducto flexible doble capa en inoxidable, disponible en dos gamas de espesores.
Flexible double-layer, stainless steel piping, available in 2 thickness ranges.
Conduit flexible, double peau, en acier inoxydable, disponible en deux gammes d'épaisseurs.

Página | Page
146

16
AC

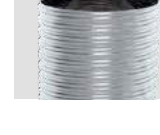

ACCESORIOS | ACCESSORIES | ACCESSOIRES
Cubreaguas, salidas de techo y accesorios.
Roof flashing, rooftops and accessories.
Solins, sorties de toit et accessoires.

Página | Page
150

17
CP



PP
AISI 304
Ø60-200
Ø60/100-Ø250/400

CONDUCTO DE POLIPROPILENO | POLYPROPYLENE PIPING | CONDUIT DE POLYPROPYLENE
Sistemas de conductos modulares en Polipropileno, aluminio e inoxidable.
Single and Double Wall modular duct systems in Polypropylene, aluminium and stainless steel.
Systèmes de conduits modulaires en polypropylène, aluminium et acier inoxydable.

Página | Page
160

18
Info



INFO

Página | Page
164

1 SP

Simple Pared
Single Wall
Simple Paroi

Ø80 - 400

1 Sombreros: antilluvia, antiretorno, giratorio, salida libre, pico flauta, salida horizontal y salida vertical
Caps: rain cap, non-return cap, wind directional cap, outlet cone, flute peak cap, horizontal outlet cap and vertical outlet cap
Chapeaux: pare-pluie, anti-refoulement, aspirateur, cône de finition, de flûte, sortie horizontale et sortie verticale.

2 Terminal de obra
End piece
Solin toit

3 Módulo lineal 1.000 mm, 500 mm, 250 mm
Linear module 1.000 mm, 500 mm, 250 mm
Élément droit 1.000 mm, 500 mm, 250 mm

4 Abrazadera araña y abrazadera descenso
Spider bracket and chimney-lowering bracket
Bride araignée et collier de descente

5 Abrazadera mural interior y abrazadera forjado
Interior wall bracket and ceiling bracket
Bride mural intérieure et collier support plancher

6 Codos 15°, 30°, 45°, 87°
Elbows 15°, 30°, 45°, 87°
Coudes 15°, 30°, 45°, 87°

7 Te 90°, te 135°, rosetón
"T" piece 90°, "T" piece 135°, rosette
Té 90°, té 135°, rosace

8 Te inspección con tapa, módulo de limpieza oval
Inspection module with cap, oval cleaning module
Té inspection avec trappe, module ramonage ovale

9 Soporte mural universal con escuadras
Universal wall support with squares
Support mural universel avec équerres

10 Tapa purga
Purge cap
Tampon purge

11 Adaptadores: caldera, macho-macho, hembra-hembra y SP-DP
Adapters: boiler, male-male, female-female and SP-DW
Adaptateurs: chaudière, mâle-mâle, femelle-femelle et SP-DP

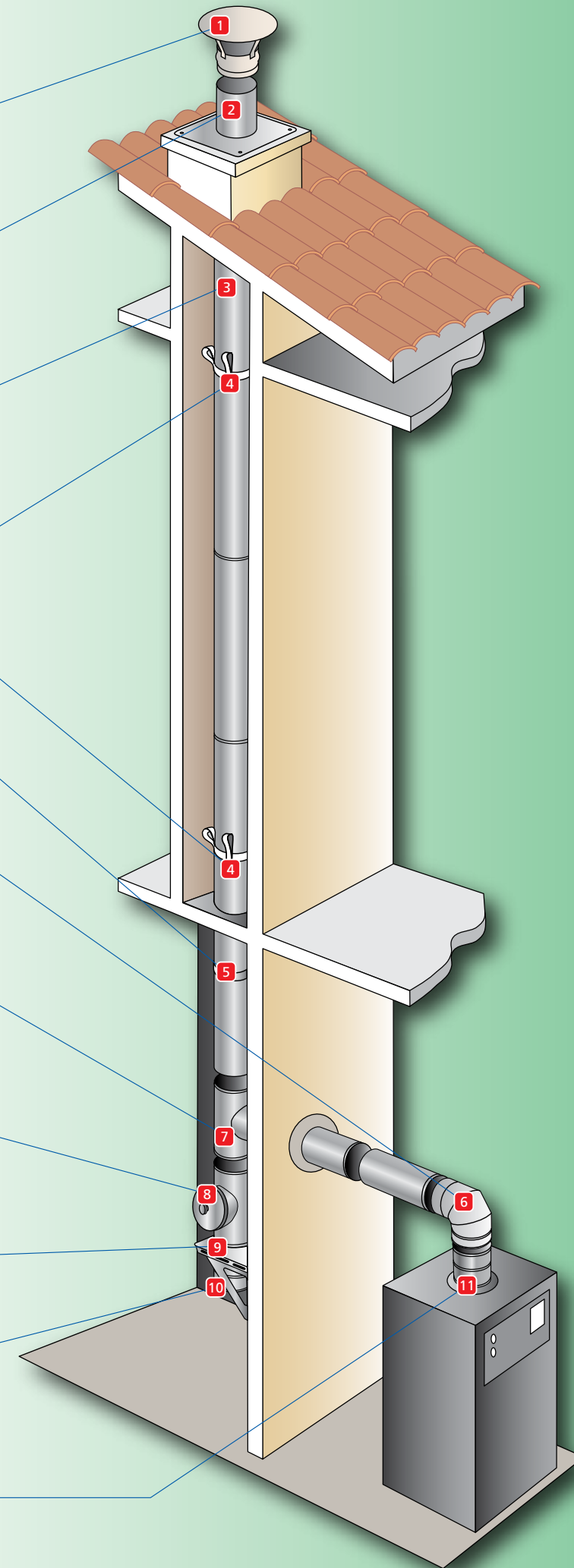

CE Especificaciones de acuerdo a la legislación europea en productos de construcción CPR
Specifications according to EU product regulations of construction CPR
Spécifications Selon la réglementation européenne concernant les produits de construction CPR

AISI 304
(1.4301) 2R



EN 1856-1

Ø80-250
T200 P1 W Vm L20040 O(30)*
T200 N1 W Vm L20040 O(30)
T300 N1 W Vm L20040 O(75)

Ø300-400
T200 P1 W Vm L20050 O(30)*
T200 N1 W Vm L20050 O(30)
T300 N1 W Vm L20050 O(75)

EN 1856-2

Ø80-250
T200 P1 W Vm L20040 O(30)M*
T200 N1 W Vm L20040 O(30)M
T600 N1 W Vm L20040 G(600)M

Ø300-400
T200 P1 W Vm L20050 O(30)M*
T200 N1 W Vm L20050 O(30)M
T600 N1 W Vm L20050 G(600)M

AISI 316L
(1.4404) 2R



EN 1856-1

Ø80-250
T200 P1 W V2 L50040 O(30)*
T200 N1 W V2 L50040 O(30)
T300 N1 W V2 L50040 O(75)

Ø300-400
T200 P1 W V2 L50050 O(30)*
T200 N1 W V2 L50050 O(30)
T300 N1 W V2 L50050 O(75)

EN 1856-2

Ø80-250
T200 P1 W V2 L50040 O(30)M*
T200 N1 W V2 L50040 O(30)M
T600 N1 W V2 L50040 G(600)M

Ø300-400
T200 P1 W V2 L50050 O(30)M*
T200 N1 W V2 L50050 O(30)M
T600 N1 W V2 L50050 G(600)M

* Para cumplir con esta designación todos los elementos deben estar instalados con juntas, consulte la página 26-27. Para saber el número de juntas, consulte la página 165.

* To comply with this designation, all elements must be installed with gaskets, see page 26-27. For the number of joints, see page 165.

* Pour respecter cette désignation, tous les éléments doivent être installés avec des joints, voir page 26-27. Unités de joints par élément, voir page 165.

Para el resto de elementos, la junta es opcional.
For all other elements, the gasket is optional.
Pour tous les autres éléments, le joint est optionnel.



Referencia Reference Référence	Ref.	2700199	Unidad de embalaje Packaging unit Unités par emballage
Precio unidad € Unit price, € Prix unité €	€ U.	29,39 6	

Módulo lineal y extensible
Linear and extendable module
Élément droit et télescopique

Módulo lineal | Linear module | Élément droit



		ØD mm						
		80	100	110	125	130	139	150
L 1000 mm								
AISI 304	Ref.	2700475	2700044	4022225	4013882	2700130	4021336	2700199
	€ U.	21,19 6	24,32 6	25,31 6	25,89 6	26,24 6	27,97 6	29,39 6
AISI 316L	Ref.	4009353	4009354	4019524	4016243	4008382	4021664	4009355
	€ U.	29,66 6	34,04 6	35,42 6	36,24 6	36,74 6	39,17 6	41,14 6
L 500mm								
AISI 304	Ref.	2700474	2700043	4022224	4013494	2700129	4021337	2700198
	€ U.	13,16 4	14,78 4	15,60 4	16,36 4	16,56 4	17,42 4	18,11 4
AISI 316L	Ref.	4010842	4011369	4019523	4016244	4014912	4021669	4014981
	€ U.	18,43 4	20,70 4	21,85 4	22,89 4	23,19 4	24,38 4	25,35 4
L 250 mm								
AISI 304	Ref.	2700473	2700042	4022223	4013493	2700128	4021338	2700197
	€ U.	7,88 4	8,66 4	9,32 4	10,00 4	10,14 4	10,57 4	10,91 4
AISI 316L	Ref.	4009591	4016229	4019522	4016230	4015437	4021670	4016231
	€ U.	11,03 4	12,12 4	13,05 4	14,01 4	14,18 4	14,78 4	15,26 4

Módulo extensible | Extendable module | Élément télescopique



		ØD mm						
		80	100	110	125	130	139	150
Lmin 500 mm - Lmax 900 mm								
AISI 304	Ref.	4022230	4022231	4022232	4013522	2700127	4021348	2700636
	€ U.	29,50 2	30,65 2	33,66 2	35,39 2	35,85 2	39,25 2	42,02 2
AISI 316L	Ref.	4010852	4022302	4022301	4016650	4016652	4021673	4016653
	€ U.	41,30 2	42,90 2	47,12 2	49,55 2	50,19 2	54,94 2	58,83 2
Lmin 335 mm - Lmax 565 mm								
AISI 304	Ref.	2700788	2700041	4022229	4013521	2700126	4021347	2700196
	€ U.	22,57 2	24,65 2	27,37 2	29,38 2	29,76 2	31,45 2	32,83 2
AISI 316L	Ref.	4010847	4016643	4019526	4016644	4014503	4021672	4014982
	€ U.	31,58 2	34,51 2	38,32 2	41,12 2	41,65 2	44,03 2	45,96 2
Lmin 200 mm - Lmax 300 mm								
AISI 304	Ref.	4015157	4012190	4022228	4013506	4007937	4021346	4008146
	€ U.	16,80 2	18,18 2	19,10 2	19,93 2	20,20 2	21,27 2	22,15 2
AISI 316L	Ref.	4010851	4016632	4019525	4016634	4016635	4021671	4016636
	€ U.	23,51 2	25,46 2	26,74 2	27,90 2	28,27 2	29,78 2	30,99 2

		153	180	200	230	250	300	350	400
AISI 304	Ref.	4021339	2700250	2700308	4007270	2700368	2700413	2700436	2700448
	€ U.	32,07 6	35,13 6	38,25 2	49,95 1	53,19 1	72,62 1	81,59 1	90,83 1
AISI 316L	Ref.	4021632	4009356	4009357	4009358	4009359	4009360	4009361	4009362
	€ U.	44,90 6	49,18 6	53,55 2	69,93 1	74,47 1	101,67 1	114,22 1	127,16 1
AISI 304	Ref.	4021343	2700249	2700307	4007271	2700367	2700412	2700619	2700447
	€ U.	19,48 4	21,03 4	22,80 2	27,91 1	30,76 1	36,30 1	42,08 1	47,09 1
AISI 316L	Ref.	4021633	4016245	4014390	4016246	4013700	4015434	4016247	4016248
	€ U.	27,26 4	29,45 4	31,92 2	39,07 1	43,04 1	50,82 1	58,92 1	65,92 1
AISI 304	Ref.	4021344	2700248	2700306	4007422	2700366	2700411	2700435	2700446
	€ U.	11,62 4	12,41 4	13,31 2	15,59 1	18,38 1	20,14 1	23,90 1	26,48 1
AISI 316L	Ref.	4021634	4016232	4014829	4016233	4016234	4015551	4016235	4016236
	€ U.	16,25 4	17,39 4	18,63 2	21,83 1	25,72 1	28,18 1	33,45 1	37,07 1

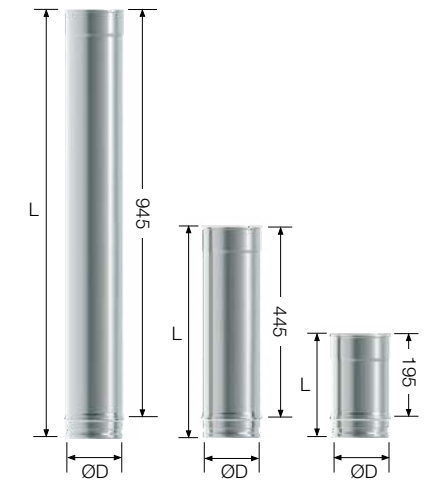

		153	180	200	230	250	300	350	400
AISI 304	Ref.	4021351	2700982	2700304	4022351	2700616	2700594	4008023	4009335
	€ U.	45,43 2	49,35 2	53,11 2	66,83 1	75,33 1	96,97 1	115,02 1	128,47 1
AISI 316L	Ref.	4021637	4015914	4014801	4022352	4016654	4016655	4016656	4016657
	€ U.	63,60 2	69,08 2	74,36 2	93,55 1	105,46 1	135,76 1	161,02 1	179,86 1
AISI 304	Ref.	4021350	2700246	2700302	4007710	2700364	2700410	2700434	2700444
	€ U.	35,65 2	38,88 2	41,14 2	49,59 1	52,75 1	73,68 1	84,72 1	100,09 1
AISI 316L	Ref.	4021636	4016645	4014389	4016646	4014983	4016647	4016648	4016649
	€ U.	49,90 2	54,43 2	57,60 2	69,43 1	73,84 1	103,15 1	118,59 1	140,11 1
AISI 304	Ref.	4021349	4008147	2700305	4012710	4007466	4015158	4015159	4015160
	€ U.	23,90 2	25,91 2	27,33 2	34,24 1	35,42 1	51,57 1	59,30 1	70,06 1
AISI 316L	Ref.	4021635	4016637	4014802	4016638	4016639	4015537	4016640	4016642
	€ U.	33,45 2	36,27 2	38,24 2	47,94 1	49,58 1	72,20 1	83,02 1	98,08 1

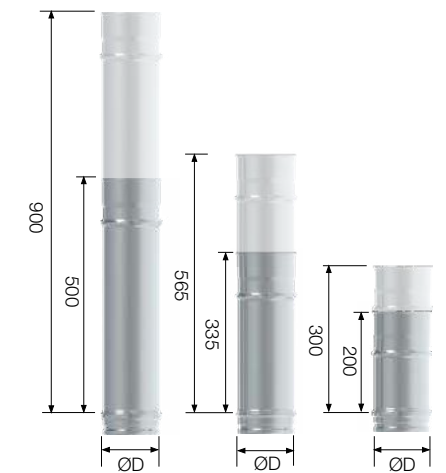

Codo
Elbow
Coude

Codo | Elbow | Coude 15°



		ØD mm						
		80	100	110	125	130	139	150
AISI 304	Ref.	4022332	4022333	4022334	4022335	4022336	4022337	4022338
	€ U.	23,30 4	23,84 4	23,89 4	25,69 4	25,57 4	26,07 4	26,54 4
AISI 316L	Ref.	4019654	4019656	4019658	4020155	4019659	4022347	4019660
	€ U.	26,81 4	27,41 4	27,47 4	29,54 4	29,83 4	29,98 4	30,53 4
Especificaciones técnicas Technical specifications Spécifications techniques								
	H	21	21	21	22	22	22	22
	V	114	117	118	120	121	122	123
	Ø	80	100	110	125	130	139	150
CSP 15° + CSP 15°	H1	30	31	31	32	32	32	33
	V1	230	235	238	242	243	245	248
CSP 15° + (L200) + CSP 15°	H1	81	81	82	82	82	83	83
	V1	417	423	425	429	430	433	436
CSP 15° + (L500) + CSP 15°	H1	145	146	146	147	147	147	148
	V1	659	664	667	671	672	674	677
CSP 15° + (L1000) + CSP 15°	H1	275	275	276	276	276	277	277
	V1	1142	1147	1150	1154	1155	1157	1160

CSP : Codo Simple Pared | Single Wall elbow | Coude Simple Paroi

		153	180	200	230	250	300	350	400
AISI 304	Ref.	4022339	4022340	4022341	4022342	4022343	4022344	4022345	4025190
	€ U.	27,78 4	29,97 4	30,94 4	31,86 1	32,51 1	40,85 1	42,80 1	45,15 1
AISI 316L	Ref.	4022348	4019661	4019662	4020156	4019663	4019664	4019665	4025191
	€ U.	31,95 4	34,46 4	35,58 4	36,64 1	37,38 1	46,99 1	49,22 1	52,62 1
	H	22	23	23	23	24	25	25	26
	V	124	127	130	133	136	142	149	155
	Ø	153	180	200	230	250	300	350	400
AISI 304	Ref.	33	34	34	35	36	38	39	41
	V1	249	255	261	268	274	286	299	312
AISI 316L	Ref.	83	84	85	86	86	88	90	91
	V1	436	443	448	456	461	474	487	500
AISI 304	Ref.	148	149	149	150	151	153	154	156
	V1	678	684	689	697	702	715	728	741
AISI 316L	Ref.	277	278	279	280	280	282	284	285
	V1	1161	1167	1172	1180	1185	1198	1211	1224

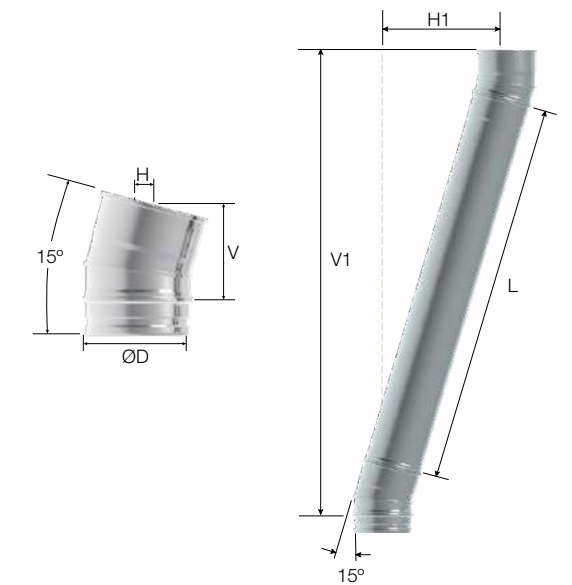

Referencia Reference Référence	Ref.	2700631	Unidad de embalaje Packaging unit Unités par emballage
Precio unidad € Unit price, € Prix unité €	€ U.	18,62 4	

Codo
Elbow
Coude

Codo | Elbow | Coude 30°



ØD mm	80	100	110	125	130	139	150	
AISI 304	Ref.	4014431	4018796	4022349	4013535	4007665	9021368	2700631
	€ U.	12,34 4	14,18 4	14,65 4	17,25 4	17,48 4	18,11 4	18,62 4
AISI 316L	Ref.	4015623	4019645	4019531	4016557	4016558	4021651	4014976
	€ U.	17,27 4	19,84 4	20,52 4	24,16 4	24,46 4	25,34 4	26,06 4

Especificaciones técnicas | Technical specifications | Spécifications techniques

H	43	44	45	46	46	47	48
V	111	117	119	123	124	126	129

Ø	80	100	110	125	130	139	150	
CSP 30° + CSP 30°	H1	62	64	66	68	68	69	71
	V1	230	240	245	252	255	259	265
CSP 30° + L(250) + CSP 30°	H1	159	161	163	165	165	166	168
	V1	398	408	413	420	423	427	433
CSP 30° + L(500) + CSP 30°	H1	284	286	288	290	290	291	293
	V1	614	624	629	637	639	644	649
CSP 30° + L(1000) + CSP 30°	H1	534	536	538	540	540	541	543
	V1	1047	1057	1062	1070	1072	1077	1082

CSP : Codo Simple Pared | Single Wall elbow | Coude Simple Paroi

Codo | Elbow | Coude 45°



ØD mm	80	100	110	125	130	139	150	
AISI 304	Ref.	2700468	2700036	4022350	4013536	2700122	4021369	2700191
	€ U.	12,34 4	14,18 4	14,65 4	17,25 4	17,48 4	18,11 4	18,62 4
AISI 316L	Ref.	4010245	4011367	4019532	4016563	4014913	4021652	4014984
	€ U.	17,27 4	19,84 4	20,52 4	24,16 4	24,46 4	25,34 4	26,06 4

Especificaciones técnicas | Technical specifications | Spécifications techniques

H	63	66	67	69	70	71	73
V	116	123	126	131	133	136	140

Ø	80	100	110	125	130	139	150	
CSP 45° + CSP 45°	H1	97	102	105	109	111	113	116
	V1	243	257	263	274	277	283	291
	H2	156	166	171	178	181	185	191
CSP 45° + L(250) + CSP 45°	H1	188	198	203	210	212	216	222
	V1	230	236	239	243	244	247	250
	H2	297	307	312	319	322	326	332
CSP 45° + L(500) + CSP 45°	V2	322	331	336	343	346	350	355
	H1	403	408	411	415	416	419	422
	V1	565	579	586	596	599	606	613
CSP 45° + L(1000) + CSP 45°	H2	478	488	493	501	503	508	513
	V2	494	504	508	515	518	522	527
	H1	747	752	755	759	760	763	766
CSP 45° + L(1000) + CSP 45°	V1	928	942	948	959	962	968	976
	H2	841	851	856	863	866	870	876
	V2	838	848	852	860	862	866	871

CSP : Codo Simple Pared | Single Wall elbow | Coude Simple Paroi

Codo | Elbow | Coude 87°



ØD mm	80	100	110	125	130	139	150	
AISI 304	Ref.	2700469	2700037	9022075	4013537	2700123	9021370	2700192
	€ U.	18,15 4	20,15 4	21,42 4	22,68 4	22,98 4	23,87 4	24,61 4
AISI 316L	Ref.	4009838	4010442	4019533	4016567	4014915	4021653	4010654
	€ U.	25,42 4	28,19 4	29,99 4	31,75 4	32,17 4	33,41 4	34,44 4

Especificaciones técnicas | Technical specifications | Spécifications techniques

H	91	100	105	112	115	119	124
V	138	148	153	161	163	168	173

153	180	200	230	250	300	350	400
4021372	2700981	4007664	4009540	2700355	4008150	4009541	4028109
20,89 4	23,49 4	28,16 4	30,56 1	33,62 1	46,64 1	57,59 1	62,72 1
4021655	4016559	4014979	4016560	4014980	4016561	4016562	4029513
29,25 4	32,89 4	39,42 4	42,78 1	47,07 1	65,30 1	80,63 1	105,29 1

48	50	51	53	54	58	61	64
130	136	141	148	153	166	178	191

153	180	200	230	250	300	350	400
71	75	77	81	84	91	97	104
266	278	288	304	313	338	363	388
168	172	174	178	181	188	194	201
434	446	456	472	482	507	532	557
293	297	299	303	306	313	319	326
651	663	673	688	698	723	748	773
543	547	549	553	556	563	569	576
1084	1096	1106	1121	1131	1156	1181	1206

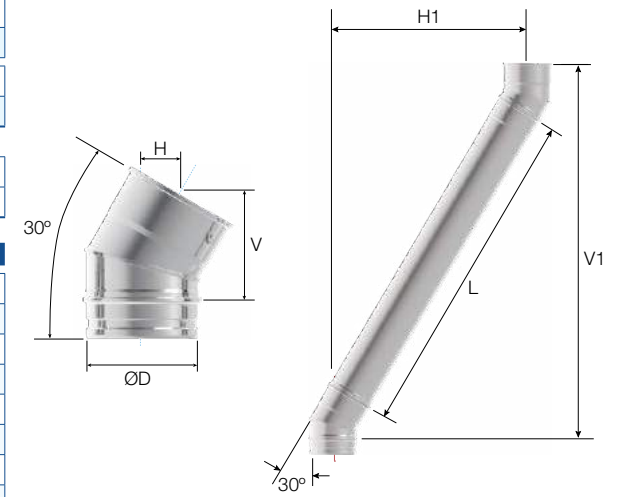

153	180	200	230	250	300	350	400
4021374	2700242	2700296	4007272	2700356	2700404	2700432	2700443
20,89 4	23,49 4	28,16 4	30,56 1	33,62 1	46,64 1	57,59 1	62,72 1
4021656	4016564	4014388	4016565	4014985	4015041	4013096	4016566
29,25 4	32,89 4	39,42 4	42,78 1	47,07 1	65,30 1	80,63 1	105,29 1

73	76	79	83	86	93	100	107
141	149	156	167	173	191	208	225

153	180	200	230	250	300	350	400
117	124	129	138	143	157	170	184
293	310	324	345	358	393	427	462
192	205	215	230	240	265	290	315
223	235	244	259	268	292	315	339
250	257	263	271	277	290	304	318
434	451	465	486	499	534	568	602
333	346	356	371	381	406	431	455
357	368	378	392	401	425	449	473
423	429	435	443	449	462	476	490
615	632	646	667	680	715	749	784
515	527	537	552	562	587	612	637
529	540	550	564	574	597	621	645
767	774	779	787	793	807	820	834
978	995	1009	1030	1043	1078	1112	1146
877	890	900	915	925	950	975	1000
873	885	894	908	918	941	965	989

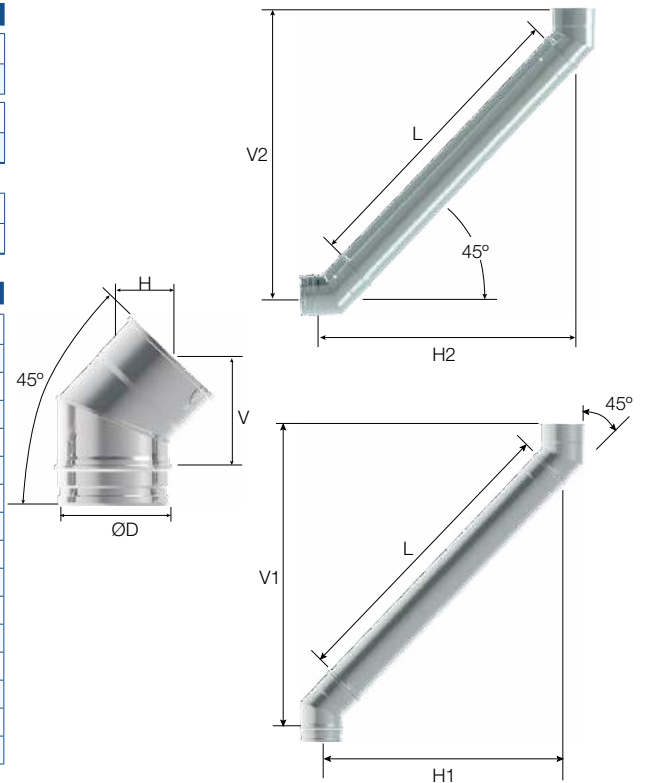

153	180	200	230	250	300	350	400
4021375	2700243	2700298	4022284	2700358	2700405	2700433	2700635
26,19 4	28,02 4	31,36 4	41,44 1	45,86 1	75,63 1	92,65 1	110,40 1
4021657	4016556	4014800	4022285	4014986	4015433	4016568	4016569
36,67 4	39,21 4	43,91 4	58,01 1	64,20 1	105,87 1	120,44 1	143,51 1

125	137	147	161	170	194	218	242
175	187	197	212	222	247	272	297

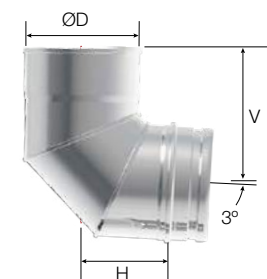

Referencia Reference Référence	Ref.	4019934	Unidad de embalaje Packaging unit Unités par emballage
Precio unidad € Unit price, € Prix unité €	€ U.	70,93 4	

CoUDE
Elbow
Coude

Codo con soporte | Elbow with bracket | Coude avec support 87°



ØD mm	80	100	110	125	130	139	150	
AISI 316L	Ref.	4019930	4019931	4019932	4022288	4019933	4022290	4019934
	€ U.	56,67 4	59,07 4	59,79 4	63,86 4	63,86 4	67,51 4	70,93 4
Especificaciones técnicas Technical specifications Spécifications techniques								
H	98	108	113	120	123	127	133	
V1	133	143	148	155	157	161	167	
V2	191	211	221	236	241	250	263	
A	96	112	120	132	136	143	158	

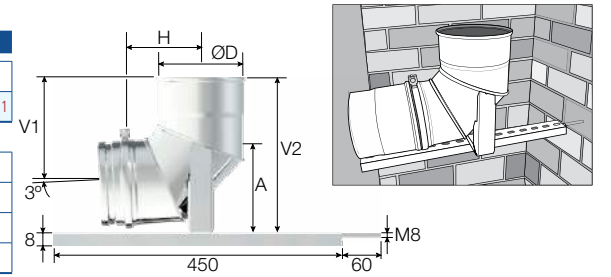

Adaptador
Adapter
Adaptateur

Adaptador caldera | Boiler adapter | Adaptateur chaudière



ØD mm	80	100	110	125	130	139	150	
AISI 304	Ref.	2700463	2700031	4022439	4013911	2700116	4021393	2700185
	€ U.	12,33 4	13,78 4	14,21 4	14,43 4	14,62 4	15,13 4	15,55 4
AISI 316L	Ref.	4010848	4016593	4022442	4016594	4016595	4021684	4016596
	€ U.	17,26 4	19,30 4	19,90 4	20,20 4	20,46 4	21,19 4	21,77 4

Adaptador caldera antihollín | Anti-soot boiler adapter | Adaptateur chaudière anti-bistre



ØD mm	80	100	110	125	130	139	150	
AISI 316L	Ref.	-	4025397	4025399	4025400	4025401	4025402	4025403
	€ U.	-	20,12 4	21,12 4	21,81 4	21,96 4	22,76 4	23,06 4
Especificaciones técnicas Technical specifications Spécifications techniques								
ØDi	-	80	90	105	110	119	132	
ØDe	-	102	112	127	132	141	152	

Adaptador SP - DP | SW - DW Adapter | Adaptateur SP - DP



ØD mm	80	100	110	125	130	139	150	
AISI 304	Ref.	4007484	2700013	4022451	4013792	2700092	4021394	2700160
	€ U.	26,66 1	27,73 1	30,55 1	32,38 1	32,81 1	34,70 1	36,25 1
AISI 316L	Ref.	4012225	4016601	4022452	4016602	4015766	4021685	4014568
	€ U.	34,66 1	38,83 1	42,78 1	45,33 1	45,92 1	48,57 1	51,34 1

Adaptador Macho - Macho | Male - Male Adapter | Adaptateur Mâle - Mâle



ØD mm	80	100	110	125	130	139	150	
AISI 304	Ref.	2700465	2700033	4022478	4013912	2700119	4021395	2700188
	€ U.	8,39 4	9,87 4	12,11 4	12,70 4	12,85 4	13,34 4	13,74 4
AISI 316L	Ref.	4010845	4016603	4022479	4016604	4016605	4021686	4014994
	€ U.	11,75 4	13,81 4	16,95 4	17,78 4	17,99 4	18,68 4	19,24 4

Adaptador Hembra - Hembra | Female - Female Adapter | Adaptateur Femelle - Femelle



ØD mm	80	100	110	125	130	139	150	
AISI 304	Ref.	2700464	2700032	4022476	4013913	2700118	4021396	2700187
	€ U.	8,64 4	10,33 4	10,85 4	11,00 4	11,15 4	12,05 4	12,77 4
AISI 316L	Ref.	4009592	4015046	4022477	4016612	4016613	4021687	4014990
	€ U.	12,09 4	14,46 4	15,18 4	15,41 4	15,61 4	16,87 4	17,88 4

Paso mural | Wall bushing | Traversée de mur



ØD mm	80	100	110	125	130	139	150	
AISI 316L	Ref.	4019781	4019782	4019783	-	4019784	-	4019785
	€ U.	33,79 4	36,01 4	36,01 4	-	36,07 4	-	37,15 4

153	180	200	230	250	300	350	400
4022292	4019935	4019936	4022295	4019937	4019938	4019939	4019940
73,93 4	81,27 4	88,33 4	91,82 1	95,52 1	125,34 1	143,12 1	156,45 1
134	147	157	172	182	207	232	257
168	180	189	204	213	237	260	284
266	291	311	341	359	409	459	509
160	180	196	220	239	279	319	359

153	180	200	230	250	300	350	400
4021397	2700237	2700291	4022443	2700732	2700399	4030562	4029553
17,51 4	19,76 4	24,42 4	28,44 1	31,05 1	47,03 1	55,92 1	63,87 1
4021663	4016597	4016598	4022445	4016599	4016600	4030563	4029555
24,51 4	27,65 4	34,19 4	39,81 1	43,48 1	65,84 1	73,04 1	81,97 1

153	180	200	230	250	300	350	400
4025405	4025406	4025407	4025408	4025409	-	-	-
23,31 4	33,15 4	34,24 4	40,04 1	45,00 1	-	-	-
133	158	178	208	228	-	-	-
155	182	202	232	252	-	-	-

153	180	200	230	250	300	350	400
4021398	2700213	2700262	-	2700322	2700825	4008960	4027340
39,92 1	44,13 1	47,06 1	-	59,19 1	94,18 1	114,94 1	124,39 1
4021665	4015915	4014579	-	4014569	4023385	4014405	4028927
55,89 1	61,77 1	65,88 1	-	76,95 1	122,44 1	149,41 1	161,79 1

153	180	200	230	250	300	350	400
4021399	2700239	2700293	2700525	2700352	2700401	4008295	4011679
14,20 4	14,74 4	15,35 4	18,20 1	20,23 1	33,44 1	45,79 1	51,74 1
4021667	4016606	4016607	4016608	4016609	4016610	4016611	4040015
19,89 4	20,64 4	21,48 4	25,47 1	28,31 1	46,82 1	64,11 1	75,46 1

153	180	200	230	250	300	350	400
4021400	2700238	2700292	4014532	2700351	2700400	2700431	4009297
13,31 4	13,93 4	16,25 4	20,66 1	21,96 1	32,45 1	43,56 1	51,57 1
4021668	4016614	4016615	4022480	4016616	4016617	4016618	4040016
18,63 4	19,49 4	22,76 4	28,92 1	30,75 1	45,42 1	60,98 1	72,13 1

153	180	200	230	250	300	350	400
-	4019786	4019787	-	4019788	4019789	4019790	-
-	38,63 4	39,64 4	-	43,07 1	51,91 1	56,88 1	-

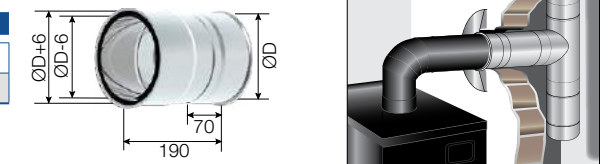
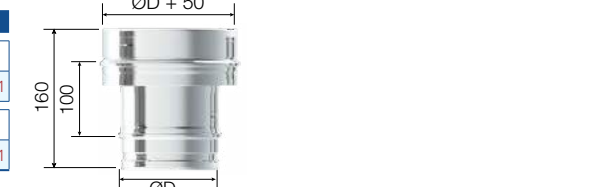
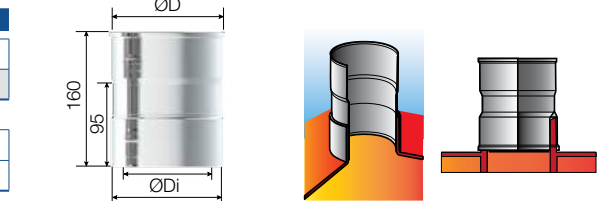
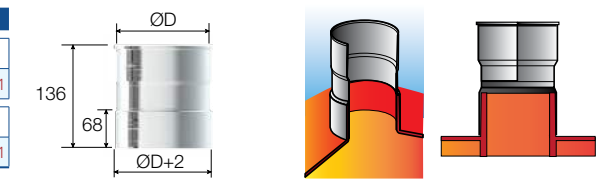

Te y tapa
"T" Piece and cap
Té et tampon

Te | "T" piece | Té 90° *



		ØD mm						
		80	100	110	125	130	139	150
AISI 304	Ref.	4022162	4022163	4022164	4022165	4022166	4022167	4022168
	€ U.	22,89 3	25,16 3	26,27 3	27,55 3	28,53 3	29,92 2	32,66 2
AISI 316L	Ref.	4022035	4022036	4019527	4022037	4022038	4022039	4022040
	€ U.	32,04 3	36,70 3	36,77 3	38,32 3	39,66 3	41,89 2	45,72 2
Especificaciones técnicas Technical specifications Spécifications techniques								
V		75	85	90	100	100	100	117
H		90	100	105	113	115	120	125
L		193	213	223	243	243	243	276

Te | "T" Piece | Té 93° *



		ØD mm						
		80	100	110	125	130	139	150
AISI 304	Ref.	4019580	4019581	4022195	4019582	4019583	4022196	4019584
	€ U.	22,89 3	25,16 3	26,27 3	27,55 3	28,53 3	29,92 2	32,66 2
AISI 316L	Ref.	4022073	4022074	9022076	9022077	4022078	4022079	4022080
	€ U.	32,04 3	35,54 3	36,77 3	38,32 3	39,66 3	41,89 2	45,72 2
Especificaciones técnicas Technical specifications Spécifications techniques								
V		70	80	85	94	94	94	110
H		92	103	108	116	119	123	129
L		193	213	223	243	243	243	276

Te | "T" Piece | Té 135° *



		ØD mm						
		80	100	110	125	130	139	150
AISI 304	Ref.	4022237	4022238	4022239	4022240	4022242	4022243	4022244
	€ U.	32,95 2	34,87 2	35,59 2	36,29 2	36,75 2	43,84 2	49,63 2
AISI 316L	Ref.	4022250	4022251	4019528	4022254	4022255	4022256	4022257
	€ U.	46,13 2	48,82 2	49,82 2	50,81 2	51,45 2	61,38 2	69,48 2
Especificaciones técnicas Technical specifications Spécifications techniques								
V		21	28	32	37	39	42	46
H		111	128	137	149	154	161	171
L		227	256	270	291	298	311	326

Te base con tapa | Base "T" Piece with cap | Té base avec tampon 90°



		ØD mm						
		80	100	110	125	130	139	150
AISI 316L	Ref.	4021627	4011365	-	-	4034950	-	4034951
	€ U.	54,13 1	59,55 1	-	-	65,04 1	-	70,97 1
Especificaciones técnicas Technical specifications Spécifications techniques								
A		93	103	-	-	118	-	128
L		237	237	-	-	272	-	287

Tapa | Cap | Tampon



		ØD mm						
		80	100	110	125	130	139	150
AISI 304	Ref.	2700481	2700050	4022428	4013673	2700136	4021355	2700204
	€ U.	9,60 4	10,23 4	13,37 4	15,63 4	15,84 4	16,37 4	16,80 4
AISI 316L	Ref.	4010844	4015924	4019529	4015926	4015927	4021676	4014992
	€ U.	13,43 4	14,31 4	18,73 4	21,88 4	22,18 4	22,91 4	23,51 4

Tapa purga | Condensate cap | Tampon récupérateur condensats



		ØD mm						
		80	100	110	125	130	139	150
AISI 304	Ref.	2700482	2700051	4022401	4013672	2700137	4021356	2700205
	€ U.	15,77 4	16,34 4	17,27 4	18,12 4	18,38 4	18,70 4	18,97 4
AISI 316L	Ref.	4015544	4015955	4019530	4015932	4014506	4021677	4015057
	€ U.	22,08 4	22,86 4	24,17 4	25,36 4	25,72 4	26,17 4	26,56 4
Especificaciones técnicas Technical specifications Spécifications techniques								
ØG		1/2"	1/2"	1/2"	1/2"	1/2"	1/2"	1/2"

Regulador de tiro | Draft regulator | Modérateur de tirage

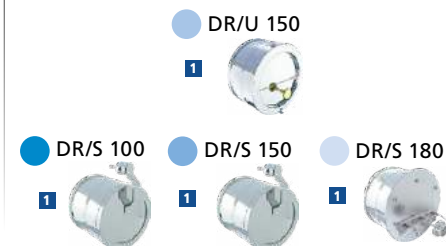

		ØD mm						
		80	100	110	125	130	139	150
		DR/U 150						
Ref.		-	-	-	-	4025655	4025702	4025656
€ U.		-	-	-	-	88,92 1	89,64 1	89,73 1
		DR/S 100			DR/S 150			
Ref.		4025716	4025717	4025718	4025719	4025720	4025721	4025722
€ U.		149,61 1	151,25 1	153,69 1	154,49 1	166,45 1	167,17 1	166,68 1

Referencia	Ref.	4022168	Unidad de embalaje
Reference	Ref.	4022168	Packaging unit
Référence	Ref.	4022168	Unités par emballage
Precio unidad €	€ U.	32,66 2	
Unit price, €	€ U.	32,66 2	
Prix unité €	€ U.	32,66 2	

		153	180	200	230	250	300	350	400
4022169	4022171	4022172	4022173	4022174	4022221	2700978	4009296		
35,66 2	39,08 2	43,42 2	47,76 1	56,16 1	71,50 1	118,89 1	157,24 1		
4022041	4022042	4022043	4022045	4022047	4022048	4022049	4022051		
49,92 2	54,71 2	60,80 2	66,87 1	78,62 1	100,11 1	152,30 1	205,34 1		
117	126	136	151	161	201	211	236		
127	139	149	164	174	199	224	249		
276	293	313	343	363	443	463	513		

		153	180	200	230	250	300	350	400
4022197	4019585	4019586	4019587	4019588	4019589	4019590	4019591		
35,66 2	39,08 2	43,42 2	47,76 1	56,16 1	71,50 1	118,89 1	157,24 1		
4022081	4022082	4022083	4022084	4022085	9022086	4022087	4022088		
49,92 2	54,71 2	60,80 2	66,87 1	78,62 1	100,11 1	152,30 1	205,34 1		
110	118	127	142	151	190	198	222		
131	144	154	170	181	207	233	259		
276	293	313	343	363	443	463	513		

		153	180	200	230	250	300	350	400
4022245	4018147	4022246	4022247	4022248	4011126	4022249	4011173		
52,66 2	56,12 2	61,14 2	65,14 1	68,71 1	139,20 1	179,01 1	198,81 1		
4022259	4022262	4022264	4022265	4022269	4022271	4022272	4022273		
73,73 2	78,57 2	85,59 2	91,19 1	96,20 1	194,90 1	250,61 1	278,33 1		
47	56	63	73	80	98	116	133		
173	195	212	237	254	297	340	382		
331	366	394	437	465	536	606	677		

		153	180	200	230	250	300	350	400
-	4034952	4034953	-	-	-	-	-	-	-
-	79,85 1	89,97 1	-	-	-	-	-	-	-
-	142	152	-	-	-	-	-	-	-
-	320	337	-	-	-	-	-	-	-

		153	180	200	230	250	300	350	400
4021359	2700255	2700313	4015545	2700373	2700864	2700905	2700979		
18,06 4	19,51 4	20,71 4	24,23 1	25,63 1	38,67 1	50,63 1	58,52 1		
4021642	4015928	4014991	4016288	4014993	4015953	4015929	4015930		
25,28 4	27,32 4	28,99 4	33,91 1	35,87 1	54,14 1	70,89 1	81,94 1		

		153	180	200	230	250	300	350	400
4021360	2700596	2700314	4022402	2700374	2700865	2700869	2700980		
20,42 4	22,08 4	23,34 4	24,23 1	28,62 1	41,64 1	54,68 1	62,24 1		
4021643	4015933	4014393	4022403	4014923	4015554	4015934	4015935		
28,59 4	30,91 4	32,68 4	33,91 1	40,08 1	58,29 1	76,55 1	87,14 1		
1/2"	3/4"	3/4"	3/4"	3/4"	3/4"	1"	1"		

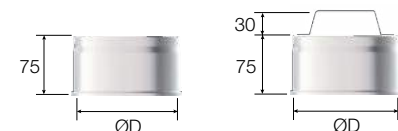
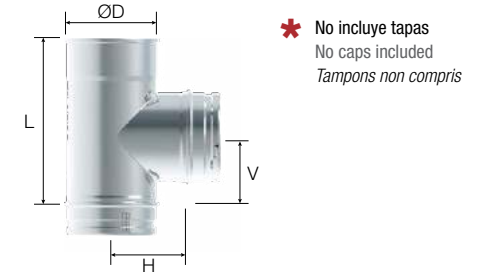
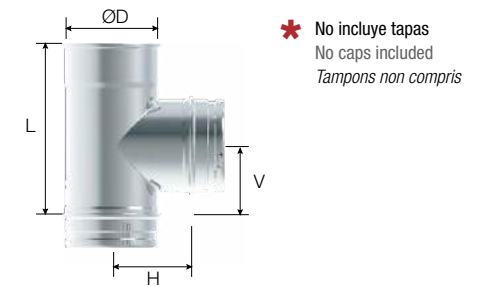

Regulador de tiro
Draft regulator
Modérateur de tirage

**Montaje del moderador de tiro
Draft regulator assembly
Montage du modérateur de tirage**

1 Montado en una Te de 90°. Vea la ilustración
Mounted on a 90° "T" Piece. See the image
Se monte sur un Té 90°. Voir illustration

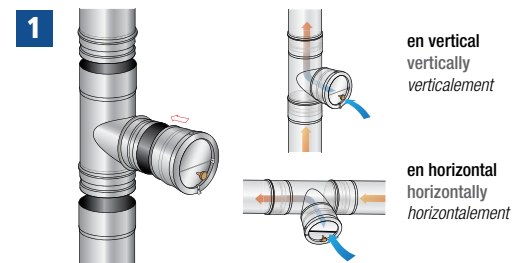

Referencia Référence Référence	Ref.	4019693	Unidad de embalaje Packaging unit Unités par emballage
Precio unidad € Unit price, € Prix unité €	€ U.	34,96	1

Tapa
Cap
Tampon

Tapa purga lateral | Lateral purge cap | Tampon récupérateur condensats laterale



ØD mm	80	100	110	125	130	139	150	
AISI 316L	Ref.	4019678	4019680	4019691	4022405	4019692	4022406	4019693
	€ U.	31,15	32,15	32,84	33,77	33,77	34,83	34,96
Especificaciones técnicas Technical specifications Spécifications techniques								
ØG	1/2"	1/2"	1/2"	1/2"	1/2"	1/2"	1/2"	

Módulo purga lateral | Lateral purge module | Module récupérateur condensats latérale



ØD mm	80	100	110	125	130	139	150	
AISI 316L	Ref.	4020210	4020211	-	4020212	4020213	-	4020214
	€ U.	37,38	38,58	-	40,52	40,52	-	41,95
Especificaciones técnicas Technical specifications Spécifications techniques								
ØG	1/2"	1/2"	-	1/2"	1/2"	-	1/2"	

Módulo de inspección
Inspection module
Module d'inspection

Módulo de limpieza oval con tapa | Oval cleaning module with cap | Module ramonage ovale avec trappe



ØD mm	80	100	110	125	130	139	150	
AISI 316L	Ref.	-	4017160	-	-	4017162	-	4017163
	€ U.	-	95,41	-	-	98,89	-	101,55

Módulo de inspección | Inspection module | Module inspection



ØD mm	80	100	110	125	130	139	150	
AISI 304	Ref.	4021835	4021836	4021837	4021838	4021839	4022279	4021840
	€ U.	28,85	31,53	32,43	33,06	33,51	37,70	41,15
AISI 316L	Ref.	4020116	4020117	4020118	4020157	4020119	4022281	4020120
	€ U.	45,47	51,01	54,75	58,60	59,39	64,79	69,23
Especificaciones técnicas Technical specifications Spécifications techniques								
L	193	213	223	243	243	243	276	
* ØT	80	100	110	130	130	140	150	

Codo inspección | Inspection elbow | Coude inspection 87°



ØD mm	80	100	110	125	130	139	150	
AISI 316L	Ref.	4024385	4024387	-	4024390	4024391	-	4024392
	€ U.	70,62	74,79	-	84,75	85,11	-	91,95
Especificaciones técnicas Technical specifications Spécifications techniques								
H	154	166	-	181	184	-	197	
V	119	132	-	148	152	-	165	
* ØT	80	100	-	130	130	-	150	

Tapa
Cover
Trappe

Tapa de inspección | Inspection cover | Trappe d'inspection



ØD mm	80	100	110	125	130	139	150
200° C / 200 Pa							
Ref.	5003265	5003266	5004391	5003267	5003267	5004392	5003268
	€ U.	18,75	19,01	20,05	22,29	22,29	23,64
450° C / 40 Pa							
Ref.	5003391	5003392	5004389	5003393	5003393	5004390	5003394
	€ U.	26,23	30,29	31,77	34,26	34,26	36,25

Módulo analizador gas | Gas analyzer module | Module analyseur de gaz



ØD mm	80	100	110	125	130	139	150	
AISI 304	Ref.	2700472	2700040	-	4013894	2700125	-	2700195
	€ U.	31,24	31,80	-	32,62	32,78	-	33,48
AISI 316L	Ref.	4010846	4011364	-	2700806	4014502	-	4019105
	€ U.	37,45	38,65	-	39,15	40,36	-	42,56

153	180	200	230	250	300	350	400
4022407	4019694	4019695	4022408	4019696	4019697	4019698	4035156
35,05	36,72	38,49	46,21	58,84	75,64	89,36	115,64
1/2"	3/4"	3/4"	3/4"	3/4"	3/4"	3/4"	1"



153	180	200	230	250	300	350	400
-	4020215	4020216	4020217	4020218	4020219	4020220	4020221
-	44,06	46,19	55,45	70,61	90,77	107,23	138,77
-	3/4"	3/4"	3/4"	3/4"	3/4"	3/4"	1"

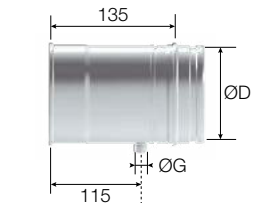

153	180	200	230	250	300	350	400
-	4017164	4017165	-	-	-	-	-
-	142,23	150,27	-	-	-	-	-

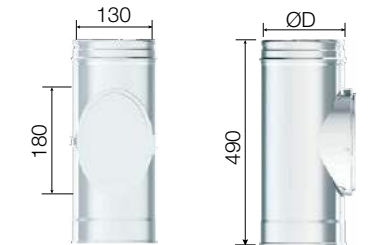

153	180	200	230	250	300	350	400
4022280	4021841	4021842	4021843	4021844	4021845	4021846	4029517
44,93	49,23	54,72	60,18	70,75	90,09	125,17	148,62
4022282	4020121	4020122	4020158	4020123	4020124	4020125	4029516
75,20	82,02	89,79	100,78	114,48	145,23	178,54	215,34
276	293	313	343	363	443	463	
150	180	200	200	250	300	300	300

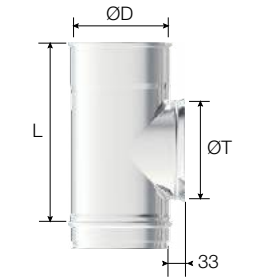

* No incluye tapas.
Escoger tapa del mismo ØT según tabla.
No caps included.
Choose cap of the same ØT according to table.
Tampons non compris.
Choisir un tampon de même ØT selon tableau

153	180	200	230	250	300	350	400
-	4024393	4024394	-	4024395	4017353	4033096	4033097
-	107,07	116,45	-	146,73	161,31	176,42	192,12
-	214	226	-	256	287	318	348
-	182	195	-	228	260	292	325
-	180	200	-	250	300	300	300

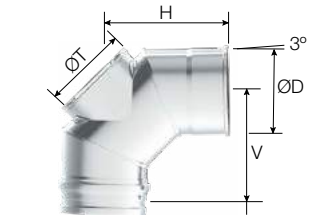

153	180	200	230	250	300	350	400
5003268	5003269	5003270	5003270	5003271	5003272	5003272	5003272
24,61	32,36	35,07	35,07	51,53	63,41	63,41	63,41
5003394	5003395	5003396	5003396	5003397	5003398	5003398	5003398
38,33	44,04	48,67	48,67	72,14	88,77	88,77	88,77

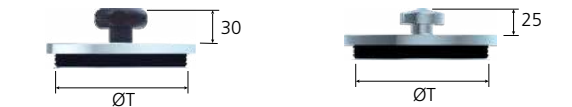

Módulo
Module
Module



ØD mm	80	100	110	125	130	139	150	
AISI 304	Ref.	2700472	2700040	-	4013894	2700125	-	2700195
	€ U.	31,24	31,80	-	32,62	32,78	-	33,48
AISI 316L	Ref.	4010846	4011364	-	2700806	4014502	-	4019105
	€ U.	37,45	38,65	-	39,15	40,36	-	42,56

153	180	200	230	250	300	350	400
-	2700245	2700301	-	2700363	2700409	2700804	2700805
-	34,37	35,87	-	37,77	43,11	47,60	53,63
-	2700810	4016097	-	2700812	2700813	2700814	2700815
-	44,12	45,41	-	48,14	54,26	58,96	64,87



Ref.	2500297
€ U.	21,60

Módulo
Module
Module

Módulo analizador gas y temperatura | Gas and temperature analyzer module | *Module analyseur de gaz et de température*



		ØD mm						
		80	100	110	125	130	139	150
AISI 304	Ref.	4016715	4016716	-	4016717	4016718	-	4016719
	€ U.	67,37	69,09	-	70,08	70,25	-	71,07
AISI 316L	Ref.	4017170	4017171	-	4017172	4017173	-	4017174
	€ U.	73,90	76,17	-	77,56	77,97	-	79,12

Referencia Reference Référence	Ref.	4016719	Unidad de embalaje Packaging unit Unités par emballage
Precio unidad € Unit price, € Prix unité €	€ U.	71,07	1

Fijación al suelo
Floor fastening
Fixation au sol

1 Tapa condensación | Condensate cap | *Tampon récupérateur condensats*



		ØD mm						
		80	100	110	125	130	139	150
AISI 316L	Ref.	4027439	4027440	4027441	4027442	4027443	4027444	4027445
	€ U.	34,25	34,98	35,37	36,33	36,50	38,40	40,14
Especificaciones técnicas Technical specifications Spécifications techniques		ØG						
		1/2"	1/2"	1/2"	1/2"	1/2"	3/4"	3/4"

2 Tubo recortable | Cut-out piping | *Élément recoupable* 500 mm, 1000 mm

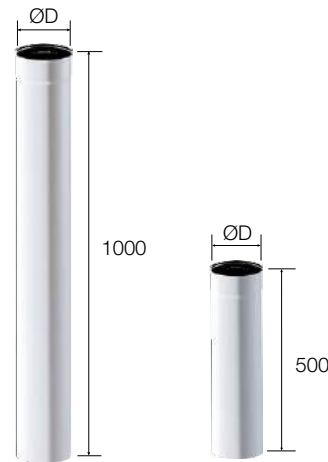

		ØD mm						
		80	100	110	125	130	139	150
L1000 mm								
AISI 304	Ref.	4019893	4019894	4027456	4019895	4019895	4027457	4019896
	€ U.	24,29	27,31	31,70	35,30	35,30	37,27	38,44
L 500 mm								
AISI 304	Ref.	4019883	4019884	4027454	4019885	4019885	4027455	4019886
	€ U.	20,70	22,26	23,99	25,63	25,63	26,59	27,19

3 Base inicial con salida lateral | Floor base with lateral outlet | *Plaque de départ avec sortie latérale*



		ØD mm						
		80	100	110	125	130	139	150
AISI 304	Ref.	4021877	4027432	4027433	4021875	4021875	4027434	4021876
	€ U.	20,06	20,73	21,01	21,75	21,75	21,94	22,35

SopORTE
Support
Support

SopORTE forjado | Ceiling support | *Plaque plancher*



		ØD mm						
		80	100	110	125	130	139	150
AISI 304	Ref.	2700974	2700967	4022028	4013905	2700968	4021364	2700969
	€ U.	51,13	52,86	54,21	57,69	58,46	59,75	61,06
AISI 316L	Ref.	4016373	4016374	4022326	4016375	4016376	4021680	4016377
	€ U.	61,36	63,43	65,04	69,23	70,15	71,70	73,27
Especificaciones técnicas Technical specifications Spécifications techniques		□ A						
		330	350	360	375	380	380	400

SopORTE forjado SP - DP | SW - DW Ceiling support | *Plaque plancher SP - DP*



		ØD mm						
		80	100	110	125	130	139	150
AISI 304	Ref.	4013071	4015135	-	4013970	4009216	-	4007590
	€ U.	64,33	65,53	-	73,04	74,59	-	82,04
AISI 316L	Ref.	4016394	4016395	-	4016396	4016399	-	4016400
	€ U.	77,20	78,64	-	87,65	89,52	-	98,45
Especificaciones técnicas Technical specifications Spécifications techniques		□ A						
		330	350	360	375	380	380	400

		153	180	200	230	250	300	350	400
-	4016720	4016721	-	4016722	4016723	4016724	4016725	-	-
-	77,65	79,32	-	81,34	95,86	101,66	112,46	-	-
-	4017175	4017177	-	4017178	4017179	4017180	4017181	-	-
-	86,63	88,70	-	91,71	109,44	116,80	124,25	-	-

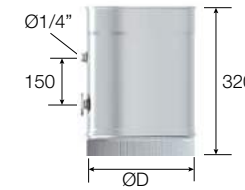

1
Pirómetro incluido
Pyrometer included
Pyromètre inclus
0-500°C

		153	180	200	230	250	300	350	400
4027446	4027447	4027448	4027449	4027450	4027451	4027452	4027453	-	-
40,23	41,90	42,98	49,80	51,18	59,18	62,56	66,77	-	-
3/4"	3/4"	3/4"	3/4"	3/4"	3/4"	1"	1"	-	-

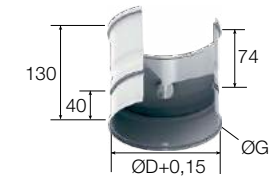

Sifón | Siphon | *Siphone*

Ref.	4030741
€ U.	29,15
max. 160°C	

Alternativas de montaje de la base inicial
Alternative floor base mounting
Possibilités de montage de la plaque de départ au sol

1 Montaje | Mounting | *Montage 1*
Con tubo recortable | With cut-out piping | *Avec tuyau recoupable*

El tubo recortable puede ser cortado a medida para que encaje perfectamente entre el suelo y la te de conexión a la caldera.
The cut-out piping can be cut to size for correct fitting between the floor and the boiler connection "T" Piece
L'élément recoupable peut être coupé sur mesure pour s'emboîter parfaitement entre le sol et le té de raccordement à la chaudière.

2 Montaje | Mounting | *Montage 2*
Sin tubo recortable
Without cut-out piping
Sans élément recoupable

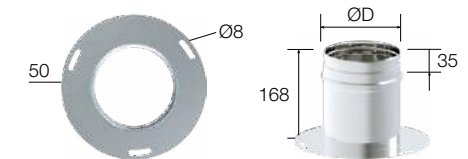

		153	180	200	230	250	300	350	400
4021876	4019971	4019973	4019974	4019975	4019977	4019978	4022033	-	-
22,35	25,32	26,47	27,92	34,35	41,62	43,56	49,69	-	-

		153	180	200	230	250	300	350	400
4021365	2700970	2700971	4022328	2700972	2700973	4022329	4022330	-	-
62,14	64,54	70,62	74,75	77,58	87,50	94,70	106,48	-	-
4021649	4016378	4016379	4022327	4016380	4016381	4016382	4022331	-	-
74,57	77,45	84,75	89,69	93,09	105,00	113,64	123,40	-	-
400	430	450	480	500	550	600	650	-	-

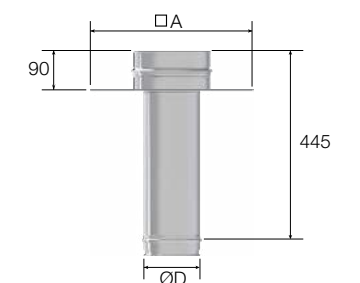
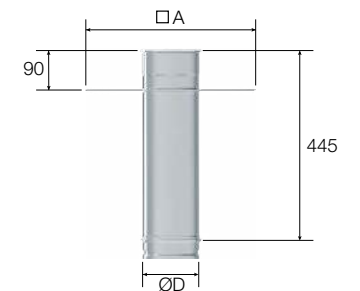

Referencia Reference Référence	Ref.	4020318	Unidad de embalaje Packaging unit Unités par emballage
Precio unidad € Unit price, € Prix unité €	€ U.	69,71	1

Soporte
Support
Support

Soporte mural intermedio | Intermediate wall support | Support mural intermédiaire *



ØD mm	80	100	110	125	130	139	150	
AISI 304	Ref.	4020313	4020315	4022425	4020316	4020317	4022426	4020318
	€ U.	51,49	55,77	60,98	68,68	69,07	69,15	69,71
AISI 316L	Ref.	4023689	4023690	4023691	4023692	4023693	4023694	4023695
	€ U.	72,09	78,07	85,34	96,16	96,69	96,80	97,58
Especificaciones técnicas Technical specifications Spécifications techniques								
A	115	135	145	160	165	174	185	
B	195	215	225	240	245	254	265	

153	180	200	230	250	300	350	400
4022427	4020319	4020320	4022429	4020321	4020322	4020323	4020324
69,71	70,64	91,71	92,58	93,64	99,80	107,39	119,57
4023696	4023697	4023698	4023699	4023700	4023701	4023702	4023703
97,58	98,89	128,39	129,60	131,10	139,72	148,68	167,30
188	213	233	263	283	333	383	433
268	293	313	343	363	413	463	513

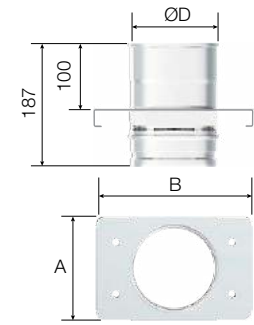

* No incluye escuadras.
Escoger modelo en pág. 32
Brackets not included.
Choose model on page 32
Supports no compris.
Choisissez le modèle, page 32

Terminal obra
Terminal
Solin toit

Terminal obra ventilado con collarín | Ventilated end piece with storm collar | Solin toit plat ventilé avec collerette



ØD mm	80	100	110	125	130	139	150	
AISI 304	Ref.	4019701	4019705	4019707	4020159	4019708	4022434	4019709
	€ U.	73,82	76,33	78,01	81,96	83,49	84,27	84,74
Especificaciones técnicas Technical specifications Spécifications techniques								
A	395	395	395	395	395	395	395	
ØDp	125	145	145	170	175	195	195	

153	180	200	230	250	300	350	400
4022437	4019710	4019711	4020160	4019712	4019713	4019714	4019728
86,32	92,04	94,11	107,70	118,84	128,15	149,01	171,22
395	450	450	450	495	495	495	-
195	222	242	272	292	342	392	-

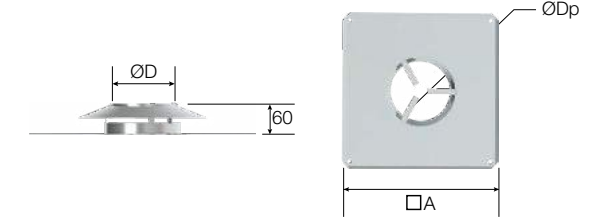

Terminal obra | End piece | Solin toit



ØD mm	80	100	110	125	130	139	150	
AISI 304	Ref.	4020097	4020098	4020099	4022440	4020100	4022430	4020101
	€ U.	54,78	55,27	55,68	61,06	64,00	64,35	64,96
Especificaciones técnicas Technical specifications Spécifications techniques								
A	390	390	390	390	390	390	390	

153	180	200	230	250	300	350	400
4022432	4020102	4020103	4022433	4020104	4020105	4020106	4019729
66,92	69,88	70,77	72,53	73,34	91,07	101,58	123,40
390	390	450	450	495	495	595	695

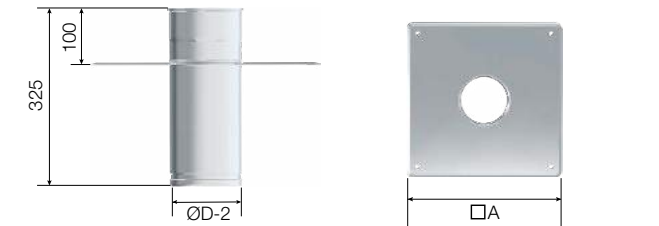

Sombrero
Cap
Chapeau

Sombrero antilluvia | Rain cap | Chapeau pare-pluie



ØD mm	80	100	110	125	130	139	150	
AISI 304	Ref.	2700476	2700045	4022481	4013733	2700132	4021379	2700200
	€ U.	29,08	30,81	30,95	30,98	31,38	31,86	32,25
AISI 316L	Ref.	4010843	4011368	4022482	4016429	4016430	4021654	4014987
	€ U.	40,72	43,13	43,33	43,37	43,93	44,60	45,14
Especificaciones técnicas Technical specifications Spécifications techniques								
V	106	106	106	106	106	106	106	
ØDp	250	250	250	300	300	300	300	

153	180	200	230	250	300	350	400
4021382	2700251	2700309	4011596	2700369	2700414	2700586	2700880
34,83	37,79	41,94	52,12	56,86	80,21	83,53	107,05
4021658	4016431	4014988	4020676	4014989	4015435	4016432	4016433
48,77	52,91	58,72	72,97	79,60	112,29	116,95	149,88
106	106	106	106	143	143	143	143
300	350	400	400	500	550	600	650

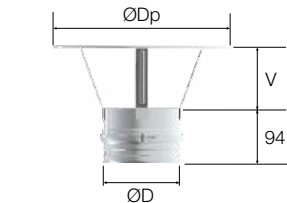

Sombrero antiretorno | Non-return cap | Chapeau anti-refoulement



ØD mm	80	100	110	125	130	139	150	
AISI 304	Ref.	2700477	2700046	4022483	4013909	2700133	4021380	2700201
	€ U.	45,82	50,63	52,53	53,46	54,17	60,64	65,93
AISI 316L	Ref.	4011403	4011370	4022484	4016439	4016440	4021662	4016441
	€ U.	64,16	70,89	73,54	74,84	75,83	84,89	92,30
Especificaciones técnicas Technical specifications Spécifications techniques								
U	142	142	142	142	142	142	142	
H	235	235	235	235	235	235	235	
ØDp	180	200	210	230	230	240	250	

153	180	200	230	250	300	350	400
4021383	2700252	2700310	4011751	2700370	4010181	2700882	2700595
69,95	74,52	84,24	95,06	102,81	130,39	148,12	168,35
4021659	4016442	4016443	4022487	4016444	4016445	4016446	4016447
97,92	104,34	117,94	133,09	143,94	182,54	207,37	235,69
142	142	200	200	200	200	200	200
235	235	293	293	293	293	293	293
250	280	350	380	400	450	500	550

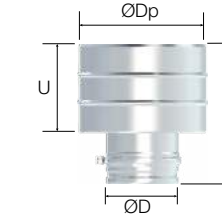

Sombrero giratorio | Wind directional cap | Chapeau aspireur



ØD mm	80	100	110	125	130	139	150	
AISI 304	Ref.	-	-	-	4013734	2500319	4021418	2500320
	€ U.	-	-	-	181,89	184,29	192,89	198,19
Especificaciones técnicas Technical specifications Spécifications techniques								
L	-	-	-	330	330	330	350	
H	-	-	-	415	415	415	435	
ØA	-	-	-	175	175	175	205	

153	180	200	230	250	300	350	400
4021419	2500321	2500322	-	2500323	2700415	2700437	-
204,82	228,66	235,87	-	259,05	345,26	441,87	-
350	350	400	-	400	420	490	-
435	435	485	-	485	505	575	-
205	205	250	-	250	260	290	-



Unión para tubo Simple Pared
Single-wall piping connection
Raccord pour tuyau Simple Paroi

Sombrero
Cap
Chapeau

Sombrero giratorio universal | Universal wind-directional cap | Chapeau aspirateur universel



		ØD mm						
		80	100	110	125	130	139	150
AISI 304	Ref.	-	-	-	-	3032088	-	3034036
	€ U.	-	-	-	-	162,04	-	169,95
Especificaciones técnicas Technical specifications Spécifications techniques								
H		-	-	-	-	330	-	350
ØA		-	-	-	-	175	-	205

Sombrero salida libre | Outlet cone | Cône de finition



		ØD mm						
		80	100	110	125	130	139	150
AISI 304	Ref.	2700479	2700048	4022485	4013736	2700134	4021381	2700202
	€ U.	24,61	27,25	29,06	31,17	31,58	34,93	37,68
AISI 316L	Ref.	4015110	4016454	4022486	4016455	4014504	4021683	4015048
	€ U.	34,44	38,16	40,69	43,63	44,22	48,90	52,76

Sombrero pico flauta | Flute peak cap | Chapeau de flûte



		ØD mm						
		80	100	110	125	130	139	150
AISI 316L	Ref.	4007540	4007541	-	4007543	4007544	-	4007546
	€ U.	44,46	46,74	-	49,93	50,73	-	62,70

Sombrero salida horizontal | Horizontal outlet cap | Chapeau sortie horizontale 500 mm



		ØD mm						
		80	100	110	125	130	139	150
AISI 304	Ref.	2700478	2700047	4023531	4013735	4007269	4021386	4040060
	€ U.	25,34	26,32	27,83	30,27	30,68	34,38	38,72
AISI 316L	Ref.	4014937	4016484	4023533	4016485	4016486	4021661	4040061
	€ U.	33,87	35,18	36,75	40,45	40,99	44,10	47,25

Sombrero salida vertical | Vertical outlet cap | Chapeau sortie verticale



		ØD mm						
		80	100	110	125	130	139	150
AISI 304	Ref.	4040062	4040063	-	4040065	4040066	-	2700659
	€ U.	29,46	30,39	-	33,99	34,20	-	40,23
AISI 316L	Ref.	4040069	4040070	-	4040072	4040073	-	4016477
	€ U.	39,37	41,32	-	45,86	48,47	-	54,68
Especificaciones técnicas Technical specifications Spécifications techniques								
L		326						
H		78	88	88	90	90	90	90

Referencia Reference Référence	Ref.	3034036	Unidad de embalaje Packaging unit Unités par emballage
Precio unidad € Unit price, € Prix unité €	€ U.	169,95	1

		153	180	200	230	250	300	350	400
-			3034041	3034042	-	3034043	3034044	3034045	-
-			194,67	207,03	-	225,57	307,97	410,46	-
-		350	400	-	400	420	490	-	-
-		205	250	-	250	260	290	-	-

		153	180	200	230	250	300	350	400
4021385		2700253	2700311	4022488	2700371	2700593	2700438	4007438	
		38,82	40,12	41,97	49,44	53,75	75,16	101,89	133,80
4021660		4016456	4014368	4022489	4013701	4015042	4013101	4016457	
		54,34	56,17	58,76	69,21	75,24	105,21	137,95	157,23

		153	180	200	230	250	300	350	400
-		4007548	4010230	-	4014635	4012570	4020915	4007550	
-		68,40	78,66	-	109,44	125,40	140,22	161,88	

		153	180	200	230	250	300	350	400
-		-	-	-	-	-	-	-	-
-		-	-	-	-	-	-	-	-

		153	180	200	230	250	300	350	400
-		2700658	2700657	-	2700656	4011811	4015665	4019424	
-		46,79	50,60	-	92,06	98,78	110,21	132,87	
-		4016478	4016480	-	4016481	4016482	4016483	4040077	
-		63,60	68,79	-	112,35	122,45	135,24	157,68	

		326				493			
90		95	150	153	179	185	239	255	

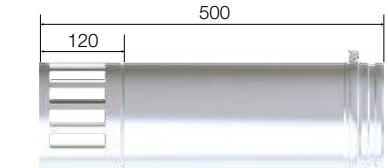
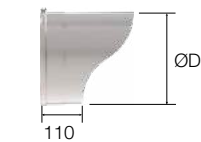
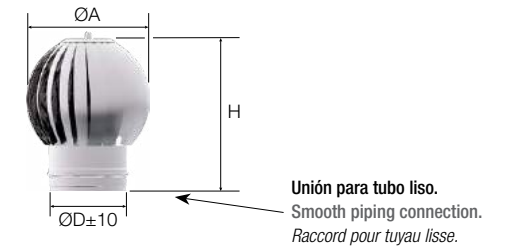

Junta
Gasket
Joint

Junta silicona | Silicone gasket | Joint silicone 200°



		ØD mm						
		80	100	110	125	130	139	150
Ref.		5003948	5003950	5004278	5003951	5003951	5004351	5003952
€ U.		1,00	1,09	1,33	1,38	1,38	1,64	1,83

Junta cerámica autoadhesiva | Self-adhesive ceramic gasket | Joint autoadhésif en céramique 600°



Ref.	2053351							
€ m.	2,46							
Especificaciones técnicas Technical specifications Spécifications techniques								
Ø m		80	100	110	125	130	139	150
(desarrollo unfolding déroulage)		0,25	0,31	0,35	0,39	0,41	0,44	0,47

Lubricante silicona | Silicone lubricant | Graisse silicone 150ml



Ref.	5002932
€ U.	6,10

Rosetón blanco | White Rosette | Rosace blanche EPDM



		80	100	125
Ref.		5005897	5005899	2700131
€ U.		4,23	5,28	7,39

		153	180	200	230	250	300	350	400
5003952		5003953	5003954	5003956	5003957	5003958	5003959	5003960	
		1,83	2,68	2,99	3,82	4,01	5,54	7,55	9,48

153	180	200	230	250	300	350	400
0,48	0,57	0,63	0,72	0,79	0,94	1,1	1,26

Aumento - Reducción | Augmentation adapter - Reduction adapter | Augmentation - Réduction

Ø	80	100	110	125	130	139	150	153	180	200	230	250	300	350	400	
80		4022589	4022591	4022598	4022607											
		42,96	44,38	46,00	45,48											
100	4015946		4022590	4022596	4015436	4022625	4022631	4022647	4022658							
	39,92		46,38	47,56	47,93	49,06	50,84	50,84	53,87							
110	4022510	4022513		4022593	4022602	4022623	4022629	4022643	4022657							
	41,09	44,53		48,78	49,00	51,55	51,97	51,97	54,93							
125	4020560	4022514	4022517		4022599	4022620	4022628	4022640	4022655	4022663						
	41,32	45,43	46,70		50,01	52,46	53,26	53,26	56,87	60,64						
130	4014505	4015045	4022520	4018342		4022615	4015653	4022639	4022651	4022662	4022674					
	42,49	46,78	48,94	47,29		52,46	53,74	53,74	58,66	62,43	63,87					
139	4022511	4022515	4022523	4022527	4022532		4022627	4022637	4022650	4022661	4022673					
	44,93	48,50	50,27	48,68	51,44		54,02	54,02	60,24	63,06	64,51					
150	4017721	4022516	4022525	4022528	4022533	4022556		4022634	4015654	4022660	4022671	4018425				
	47,29	44,97	51,43	49,90	52,26	53,40		51,41	61,89	63,88	65,67	66,79				
153		4022552	4022526	4022529	4022553	4022558	4022563		4022649	4022659	4022670	4022680				
		51,29	53,24	50,39	52,49	53,98	51,41		62,32	64,28	66,60	67,78				
180			4022530	4022554	4022560	4022564	4022567		4015655	4022668	4022678					
			51,45	53,05	56,50	51,91	51,91		65,61	68,54	69,11					
200			4022531	4022555	4022562	4015882	4022568	4022571		4022664	4015656	4022683				
			52,38	54,48	59,06	54,00	54,00	57,64		71,26	73,26	81,92				
230							4022569	4022572	4022575		4022676	4022681				
							57,49	60,36	62,36		74,69	84,81				
250							4022566	4022570	4022573	4022276	4022578		4015657	4022694	4022685	
							63,70	63,70	64,65	65,82	71,55		85,75	100,88	113,21	
300								4022574	4022576	4022579	4022581		4022687	4022686		
								70,54	74,38	77,00	77,50		104,16	112,75		
350								4022577	4022580	4022582	4022583		4022697			
								79,59	81,68	84,66	87,93					
400												4009573	4011762	4008962		
												115,67	115,01	107,80		



Unidad por embalaje: | Unit per package: | Unité par emballage: 1

ØDi mm	L = mm															
	80	100	110	125	130	139	150	153	180	200	230	250	300	350	400	
80		110	110	192	192											
100	110		110	110	110	171	192	187	243							
110	110	110		110	110	173	179	225								
125	197	110	110		110	110	110	187	235							
130	197	110	110	110		110	110	188	225	281						
139	213	176	110	110		110	110	171	208	265						
150	234	197	178	110	110		110	110	188	244	281					
153		202	184	110	110	110		150	182	239	276					
180				202	193	176	110	110		110	192	229				
200				240	230	213	193	187	110		110	192	285			
230							249	244	197	110		110	229			
250							286	281	234	197	110		192	285	378	
300									328	290	234	197		234	287	
350										383	327	290	234		192	
400												383	292	197		

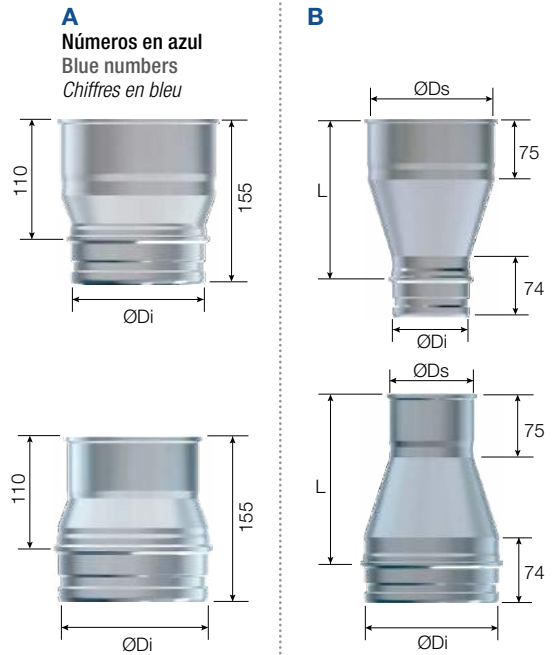

Ø	Aumento Augmentation adapter Augmentation			Reducción Reduction Adapter Réduction		
	80	100	125	80	100	125
80	68,92	71,55	77,68	77,25	71,59	77,25
100	68,92	71,55	77,68	77,25	71,59	77,25
125	77,25	71,55	76,82	77,25	71,59	77,25

Aumento y reducción excéntrica | Eccentric augmentation adapter and reduction adapter | Augmentation et réduction excentrées

Ø	80	100	110	125	130	139	150	153	180	200	230	250	300	350	400
80		4029179	4029180	4029182	4029183	4029184	4029185								
		45,31	45,89	46,63	48,12	48,86	49,58								
100	4028780			4029186	4029187	4029190	4029192	4029193	4029194						
	45,27			47,20	47,78	48,73	48,37	49,14	74,72						
110	4029062			4029195	4029196	4029199	4029200	4029203	4029206						
	45,79			48,86	47,79	48,50	48,12	48,90	74,47						
125	4029063	4029067	4029079			4029209	4029210	4029211	4029212	4029213					
	46,58	46,38	46,19			47,35	47,69	48,51	73,61	74,23					
130	4029064	4029068	4029081			4029214	4029215	4029216	4029217	4029218					
	47,06	46,76	46,53			45,36	47,50	48,32	74,62	74,03					
139	4029065	4029069	4029082	4029087	4029092		4029219	4029221	4029222	4029223					
	47,74	47,40	47,20	46,72	44,97		46,43	47,06	72,00	73,79					
150	4029066	4029070	4029084	4029088	4029093	4029117			4029224	4029225	4029226	4029227			
	48,42	47,40	47,94	47,45	47,40	45,31			73,15	75,67	77,68	77,91			
153		4029071	4029085	4029089	4029113	4029119			4029228	4029229	4029230	4029231			
		48,86	48,66	48,22	48,17	45,89			72,39	74,91	76,90	78,30			
180		4029073	4029086	4029090	4029115	4029120	4029123	4029129		4029232	4029233	4029234			
		71,61	71,41	70,93	70,93	70,73	70,29	70,78		71,80	76,35	77,47			
200				4029091	4029116	4029121	4029124	4029130	4029136		4029235	4029236	4029237	4029238	
				72,67	72,63	72,43	72,00	72,48	71,70		75,20	76,35	110,51	119,00	
230							4029125	4029133	4029137	4029139		4029239	4029240	4029241	
							74,86	75,34	76,35	73,54		73,93	105,51	114,05	
250							4029126	4029134	4029138	4029140	4029145		4029242	4029243	4029244
							77,43	77,86	77,14	76,12	73,84		106,39	114,88	124,04
300										4029142	4029146	4029148		4029245	4029246

Referencia Référence	Ref.	2500039	Unidad de embalaje Packaging unit Unités par emballage
Precio unidad € Unit price, € Prix unité €	€ U.	10,68 6	

Abrazadera mural interior | Interior wall bracket | Bride murale intérieur



ØD mm	80	100	110	125	130	139	150	153
Ref.	2500046	2500037	5003875	4013902	2500038	5004394	2500039	2500039
€ U.	7,48 6	8,55 6	9,48 6	9,77 6	10,06 6	10,39 6	10,68 6	10,68 6
Especificaciones técnicas Technical specifications Spécifications techniques								
A	120	120	120	150	150	150	150	150

Abrazadera pared regulable | Adjustable wall bracket | Collier mural réglable



ØD mm	80	100	110	125	130	139	150	153
Ref.	4600700	4600701	5003876	4600702	4600707	5004396	4600703	4600703
€ U.	9,45 1	10,67 1	11,26 1	11,75 1	12,12 1	12,88 1	14,04 1	14,04 1
Especificaciones técnicas Technical specifications Spécifications techniques								
A	156	156	156	186	186	186	186	186

Abrazadera atornillar | Screwed bracket | Collier à vis



ØD mm	80	100	110	125	130	139	150	153
Ref.	2500026	2500023	5003877	4013908	2500024	4021411	2500025	2500025
€ U.	6,21 1	6,43 1	6,62 1	6,77 1	6,88 1	6,98 1	7,07 1	7,07 1

Abrazadera de vientos | Roof brace band | Collier pour hauban



ØD mm	80	100	110	125	130	139	150	153
Ref.	2700467	2700035	4019537	4013907	2700121	4021410	2700190	2700190
€ U.	20,78 3	21,41 3	21,41 3	21,47 3	22,08 3	22,58 3	22,98 3	22,98 3

Abrazadera de unión tornillo | Connection bracket, screwed | Collier de fixation à vis



ØD mm	80	100	110	125	130	139	150	153
Ref.	5003964	5003965	5003966	5004280	5003967	5004352	5003968	5004353
€ U.	3,02 10	3,07 10	3,12 10	3,32 10	3,38 10	3,44 10	3,49 10	3,55 10

Abrazadera descenso | Chimney-lowering bracket | Collier de descente



ØD mm	80	100	110	125	130	139	150	153
Ref.	4035095	4035096	-	4035111	4035097	-	4035098	4035098
€ U.	17,66 1	18,20 1	-	18,25 1	18,77 1	-	19,53 1	19,53 1

Abrazadera araña | Spider bracket | Bride araignée



ØD mm	80	100	110	125	130	139	150	153
Ref.	4008372	4018448	4018693	4018695	4013533	4021417	4009721	4009721
€ U.	32,31 1	33,24 1	33,56 1	34,27 1	34,58 1	35,10 1	36,62 1	36,62 1

Abrazadera forjado | Ceiling bracket | Collier support plancher



ØD mm	80	100	110	125	130	139	150	153
Ref.	4022020	4022021	4022022	4028374	4022023	4022024	4022025	4022025
€ U.	22,37 1	27,24 1	27,60 1	27,95 1	27,95 1	28,28 1	28,46 1	28,46 1

Abrazadera forjado reforzada | Reinforced ceiling bracket | Collier support plancher renforcé



ØD mm	80	100	110	125	130	139	150	153
Ref.	-	-	-	4028374	4026828	-	9023220	-
€ U.	-	-	-	33,64 1	33,87 1	-	34,05 1	-
Especificaciones técnicas Technical specifications Spécifications techniques								
A	-	-	-	103	103	-	103	-
B	-	-	-	250	250	-	250	-

180	200	230	250	300	350	400
2500040	2500041	5001351	2500042	2500043	2500510	2500044
11,54 6	12,89 6	17,52 2	18,69 2	24,04 2	32,91 2	46,55 2
190	190	190	230	230	300	300

180	200	230	250	300	350	400
4600705	4600704	4600708	4600706	4600709	4600710	4600711
17,31 1	21,15 1	25,19 1	27,88 1	33,65 1	41,35 1	53,71 1
226	226	226	266	266	336	336

180	200	230	250	300	350	400
-	-	-	-	-	-	-
-	-	-	-	-	-	-

180	200	230	250	300	350	400
2700241	2700295	2700214	2700354	2700403	2700323	2700418
24,92 3	25,81 3	29,66 1	30,46 1	38,86 1	52,95 1	60,52 1

180	200	230	250	300	350	400
5003969	5003970	5003971	5003972	5003973	5003974	5003975
3,62 10	3,73 10	3,79 10	3,98 10	4,34 5	4,82 5	5,30 5

180	200	230	250	300	350	400
4035099	4035100	4035101	4035102	4035103	4035104	4035105
21,18 1	21,94 1	25,21 1	25,88 1	33,03 1	45,01 1	49,90 1

180	200	230	250	300	350	400
4012491	4016687	4027251	4025629	4016411	4016412	4016414
38,66 1	40,87 1	41,48 1	41,58 1	41,99 1	42,23 1	44,51 1

180	200	230	250	300	350	400
4022027	4011861	5001470	5001471	5001456	5001472	5001473
30,46 1	32,85 1	35,71 1	36,82 1	52,02 1	53,98 1	56,62 1

180	200	230	250	300	350	400
4026934	9023221	4026829	4023222	4023223	4023224	4023225
34,23 1	34,68 1	35,10 1	35,62 1	38,84 1	39,83 1	41,27 1
103	103	103	103	138	138	138
250	250	250	250	300	300	300

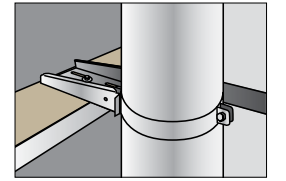
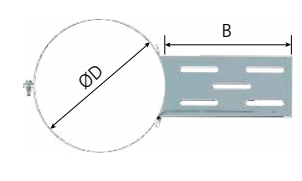
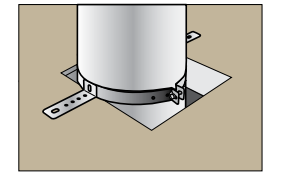
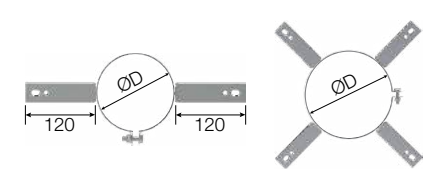
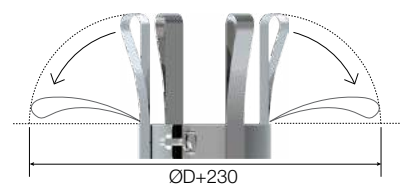
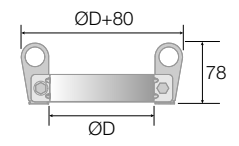
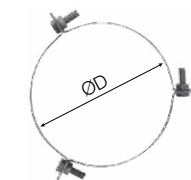
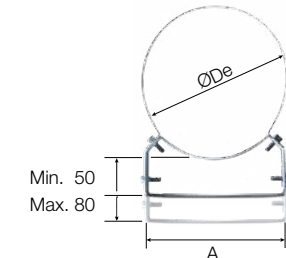
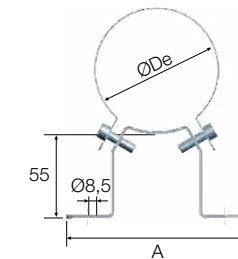

Soporte pared regulable | Adjustable wall support | Support mural réglable



ØD mm		80	100	110	125	130	139	150	153
AISI 304	Ref.	4600718	4600719	-	4600720	4600725	-	4600721	-
	€ U.	62,06	65,01	-	67,97	69,83	-	74,86	-

Especificaciones técnicas | Technical specifications | Spécifications techniques

	A	133	153	-	178	183	-	203	-
B	190	210	-	234	240	-	260	-	-

Kit escuadra soporte mural (2 unidades) | Wall-support square kit (2 units) | Kit équerre support mural (2 unités)



	Pequeño* Small* Petit*	Mediano* Medium* Moyen*	Grande* Large* Grand*
Ref.	4019925	4019926	4019927
€ Kit	51,48	68,70	72,06
L	245	360	515
H	290	430	610

* Consultar el tamaño adecuado en la pág. 165 | Refer to the appropriate size on page 165 | Voir la taille appropriée à la p.165

Soporte mural universal | Universal wall support | Support mural universel



ØD		125	130	150	180	200
AISI 304	Ref.	4028317	4026049	4026050	4026051	4026052
	€ U.	57,84	58,60	62,78	68,36	74,23

Especificaciones técnicas | Technical specifications | Spécifications techniques

	A	163	183	203	223	243
B	243	263	283	303	323	323

Escuadra reforzada (2 unidades) | Reinforced square (2 units) | Support renforcé (2 unités)



L	500 mm	750 mm	1000 mm
Ref.	5003914	5003915	5003916
€ U.	141,15	173,25	215,56

Espec. técnicas | Technical specif. | Spécif. techniques

H	310	470	600
---	-----	-----	-----

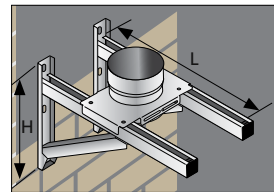

Escuadra reforzada con soporte mural
Reinforced square with wall support
Support renforcé avec support mural

Referencia Référence Référence	Ref.	4600721	Unidad de embalaje Packaging unit Unités par emballage
Precio unidad € Unit price, € Prix unité €	€ U.	74,86	1

180	200	230	250	300	350	400
4600722	4600723	4600726	4600724	4600727	4600728	4600729
78,80	86,68	100,47	108,35	123,13	140,86	162,53

232	252	282	302	351	401	452
290	310	340	360	408	458	508

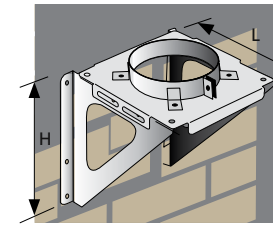
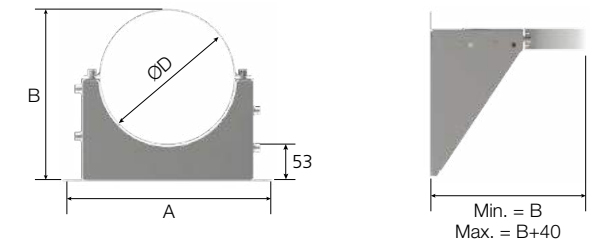

Escuadra con soporte mural
Square with wall support
Équerre avec support mural

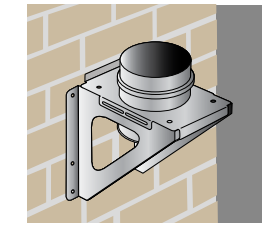

Escuadra con soporte mural intermedio
Square with intermediate wall support
Équerre avec support mural intermédiaire

230	250	300	350	400
4026053	4026054	4026059	4026060	4026061
80,92	86,98	106,37	123,23	138,23

263	283	333	383	635
343	363	413	463	515

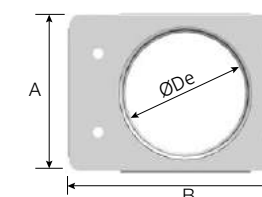

Kit fijación reforzado universal (2 unidades) | Universal reinforced fastening kit (2 units) | Kit fixation renforcé universel (2 unités)



1000 mm	
Ref.	4026055
€ U.	45,54

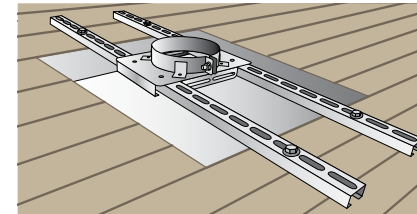

Kit fijación soporte mural universal
Universal wall support fastening kit
Kit de fixation universelle support mural

1 Apto para Soporte mural universal y Soporte mural intermedio | Suitable for universal and intermediate wall supports | Convient pour le Support mural universel et le Support mural intermédiaire

1 Abrazadera forjado universal | Universal ceiling bracket | Collier support plancher universel



ØD mm		125	130	150	180	200
AISI 304	Ref.	4028318	4026043	4026044	4026045	4026046
	€ U.	29,93	29,93	30,08	30,14	30,86

2 Fijación forjado angular (2 unidades) | Angular forged fixation (2 units) | Fixation angulaire (2 unités)



1000 mm	
Ref.	4026057
€ U.	31,62

GALVANIZADA
GALVANIZED
GALVANISÉ

230	250	300	350	400
4026047	4026048	4026080	4026081	4026082
31,28	32,11	36,21	44,68	51,43

3 Kit prolongación forjado | Forged extension kit | Kit extension étage



GALVANIZADA
GALVANIZED
GALVANISÉ

ØD mm		130	150	180	200	230	250
AISI 304	Ref.	4026038			4026042		
	€ U.	52,67			73,73		

1 2 3 Consultar las diferentes opciones de soporte en la página 165 | For support options, see page 165 | Pour les options d'assistance, voir page 165.

2 SPI

Simple Pared Industrial
Industrial Single Wall
Simple Paroi Industriel

Ø450 - 700



1 Sombreros: antilluvia, antiretorno, salida libre y bicónico
Caps: rain cap, non-return cap, outlet cone and biconical cap
Chapeaux: pare-pluie, anti-refoulement, cône de finition et bicône

2 Collarín
Storm collar
Collerette

3 Cubreaguas inoxidable horizontal
Horizontal stainless steel roof flashing
Solin inoxydable horizontal

4 Abrazadera mural exterior
Exterior wall bracket
Collier support mural extérieur

5 Módulo lineal 1.000 mm, 500 mm, 250 mm
Linear module 1.000 mm, 500 mm, 250 mm
Élément droit 1.000 mm, 500 mm, 250 mm

6 Abrazadera forjado reforzada
Reinforced ceiling bracket
Collier support plancher renforcé

7 Tapa de inspección 200°C y 450°C
Inspection cover 200°C and 450°C
Trappe d'inspection 200°C et 450°C

8 Módulo de inspección
Inspection module
Module d'inspection

9 Soporte mural intermedio
Intermediate wall support
Support mural intermédiaire

10 Escuadras reforzadas
Reinforced squares
Équerres renforcés

11 Codos 15°, 30°, 45°, 87° y 90°
Elbows 15°, 30°, 45°, 87° and 90°
Coudes 15°, 30°, 45°, 87° et 90°

12 Te 90°, 135° y te reducida
"T"piece 90°, 135° and reduction "T"piece
Té 90°, 135° et té réduit

13 Tapa purga, tapa purga lateral
Purge cap, lateral purge cap
Tampon purge, tampon purge latérale

14 Adaptadores: caldera, macho-macho, hembra-hembra y SP-DP
Adapters: boiler, double male, double female and SW-DW
Adaptateurs: chaudière, mâle - mâle, femelle - femelle et SP - DP

15 Base inicial con salida lateral
Floor base with lateral outlet
Plaque de départ au sol à purge latérale

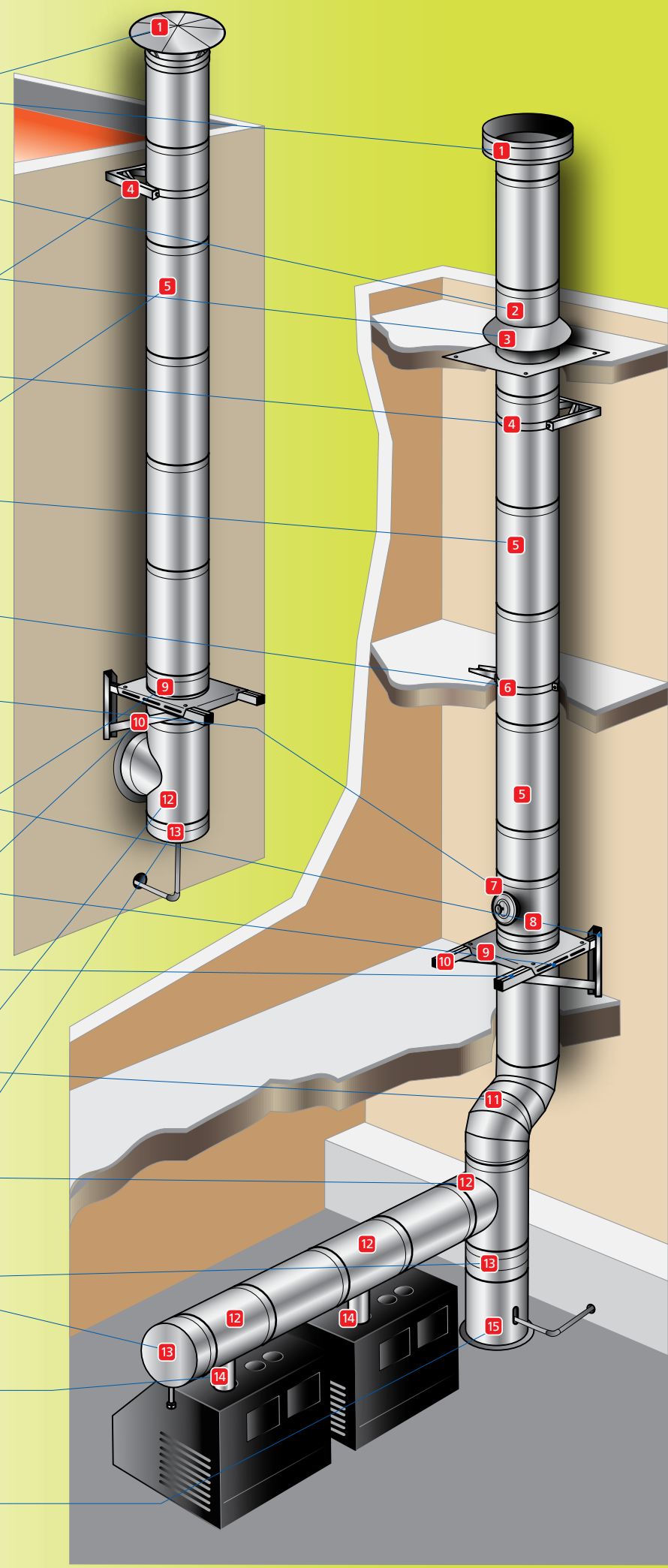

CE Especificaciones de acuerdo a la legislación europea en productos de construcción CPR
Specifications according to EU product regulations of construction CPR
Spécifications Selon la réglementation européenne concernant les produits de construction CPR

AISI 304
(1.4301) 2R

EN 1856-1
Ø450-700
T200 P1 W Vm L20060 O(30)*
T200 N1 W Vm L20060 O(30)
T300 N1 W Vm L20060 O(75)

EN 1856-2
Ø450-700
T200 P1 W Vm L20060 O(30)M*
T200 N1 W Vm L20060 O(30)M
T600 N1 W Vm L20060 G(600)M

AISI 316L
(1.4404) 2R

EN 1856-1
Ø450-700
T200 P1 W V2 L50060 O(30)*
T200 N1 W V2 L50060 O(30)
T300 N1 W V2 L50060 O(75)

EN 1856-2
Ø450-700
T200 P1 W V2 L50060 O(30)M*
T200 N1 W V2 L50060 O(30)M
T600 N1 W V2 L50060 G(600)M

* Para cumplir con esta designación todos los elementos deben estar instalados con juntas, consulte la página 43. Para saber el número de juntas, consulte la página 165.

* To comply with this designation, all elements must be installed with gaskets, see page 43. For the number of joints, see page 165.

* Pour respecter cette désignation, tous les éléments doivent être installés avec des joints, voir page 43. Unités de joints par élément, voir page 165.

○ Para el resto de elementos, la junta es opcional
For all other elements, the gasket is optional
Pour tous les autres éléments, le joint est optionnel.

Módulo lineal | Linear module | Élément droit

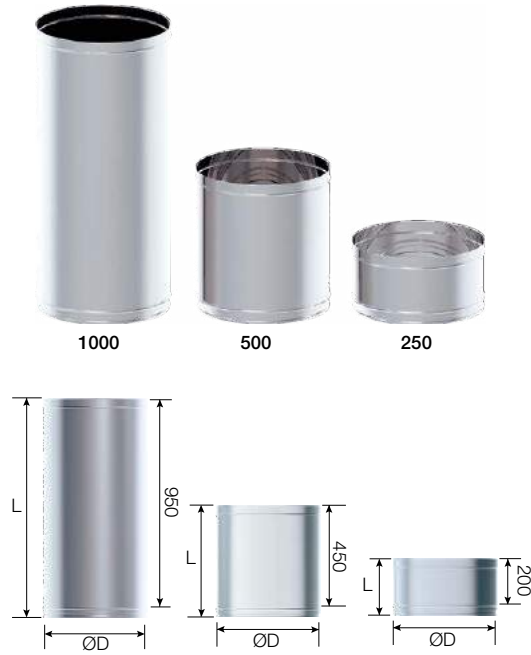

		ØD mm					
		450	500	550	600	650	700
L 1000 mm							
AISI 304	Ref.	4029576	4029699	4029850	4030039	4030124	4040100
	€ U.	110,70	136,33	168,10	202,95	240,88	292,13
AISI 316L	Ref.	4028610	4029746	4029926	4030065	4030208	4040243
	€ U.	146,58	179,38	224,48	274,70	322,88	391,55
L 500mm							
AISI 304	Ref.	4029578	4029701	4029852	4030041	4030126	4040101
	€ U.	67,41	83,03	102,38	123,60	146,78	177,88
AISI 316L	Ref.	4029645	4029748	4029928	4030067	4030210	4040244
	€ U.	89,61	111,24	136,99	166,86	196,73	237,93
L 250 mm							
AISI 304	Ref.	4029577	4029700	4029851	4030040	4030125	4040102
	€ U.	54,30	66,86	82,45	99,54	118,14	143,28
AISI 316L	Ref.	4029644	4029747	4029927	4030066	4030209	4040245
	€ U.	72,62	88,58	110,21	132,87	157,59	191,58

Módulo extensible | Extendable module | Élément télescopique



		ØD mm					
		450	500	550	600	650	700
Lmin 500 mm - Lmax 900 mm							
AISI 304	Ref.	4029565	4029684	4029825	4030026	4030112	4040105
	€ U.	199,82	239,99	290,46	334,75	390,37	454,23
AISI 316L	Ref.	4029628	4029732	4029899	4030050	4030142	4040108
	€ U.	266,77	314,15	372,86	419,21	470,71	540,75
Lmin 335 mm - Lmax 565 mm							
AISI 304	Ref.	4029564	4029683	4029824	4030025	4030111	4040104
	€ U.	142,14	170,98	207,03	237,93	277,07	324,45
AISI 316L	Ref.	4029627	4029724	4029898	4030049	4030141	4040107
	€ U.	185,40	220,42	263,68	296,64	344,02	398,61
Lmin 200 mm - Lmax 300 mm							
AISI 304	Ref.	4032467	4032468	4032469	4032470	4032471	4040103
	€ U.	99,91	119,48	146,26	169,95	200,85	235,87
AISI 316L	Ref.	4032472	4032473	4032474	4032475	4032476	4040106
	€ U.	129,78	154,50	187,46	215,27	252,35	293,55

Tubo descenso | Down piping | Élément descente



		ØD mm					
		450	500	550	600	650	700
1000 mm							
AISI 304	Ref.	4040109	4040110	4040111	4040112	4040113	4040114
	€ U.	145,70	171,33	203,10	237,95	275,88	327,13
AISI 316L	Ref.	4040115	4040116	4040117	4040118	4040119	4040120
	€ U.	181,58	214,38	259,48	309,70	357,88	426,55

Referencia Reference Référence	Ref.	4029699	Unidad de embalaje Packaging unit Unités par emballage
Precio unidad € Unit price, € Prix unité €	€ U.	136,33	1

Codo
Elbow
Coude

Codo | Elbow | Coude **15°**



		ØD mm					
		450	500	550	600	650	700
AISI 304	Ref.	4029559	4029679	4029818	4030016	4030107	4040121
	€ U.	101,85	126,10	155,20	189,15	224,07	269,66
AISI 316L	Ref.	4029617	4029719	4029868	4030045	4030135	4040125
	€ U.	127,07	156,17	194,00	235,71	277,42	334,65

Especificaciones técnicas | Technical specifications | Spécifications techniques

	H	43	44	45	46	47	48
V		282	288	295	301	308	314

		Ø					
		450	500	550	600	650	700
CSP 15° + CSP 15°	H1	74	76	78	80	81	83
	V1	565	578	591	604	617	630
	H2	158	161	165	168	171	175
CSP 15° + L(250) + CSP 15°	H1	126	128	130	131	133	135
	V1	758	771	784	797	810	823
	H2	210	213	216	220	223	227
CSP 15° + L(500) + CSP 15°	H1	191	193	194	196	198	199
	V1	1000	1013	1026	1039	1052	1065
	H2	274	278	281	285	288	291
CSP 15° + L(1000) + CSP 15°	H1	320	322	324	325	327	329
	V1	1483	1496	1509	1522	1535	1547
	H2	404	407	411	414	417	421
V2		1460	1473	1485	1498	1510	1523

CSP : Codo Simple Pared | Single Wall elbow | Coude Simple Paroi

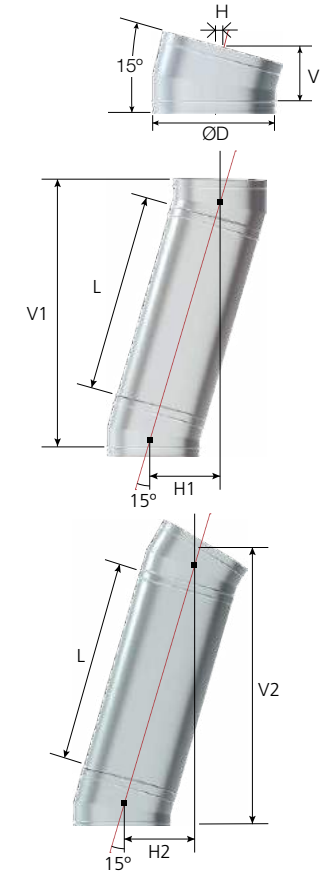

Codo | Elbow | Coude **30°**



		ØD mm					
		450	500	550	600	650	700
AISI 304	Ref.	4029560	4029680	4029819	4030018	4030108	4040122
	€ U.	126,10	155,20	187,21	220,19	258,02	311,37
AISI 316L	Ref.	4029618	4029721	4029869	4030046	4030136	4040126
	€ U.	150,35	183,33	219,22	256,08	298,76	356,96

Especificaciones técnicas | Technical specifications | Spécifications techniques

	H	115	118	122	125	128	132
V		382	395	407	420	432	445

		Ø					
		450	500	550	600	650	700
CSP 30° + CSP 30°	H1	207	213	220	227	233	240
	V1	771	796	821	846	871	896
	H2	406	418	431	443	456	468
CSP 30° + L(250) + CSP 30°	H1	307	313	320	327	333	340
	V1	944	969	994	1019	1044	1069
	H2	506	518	531	543	556	568
CSP 30° + L(500) + CSP 30°	H1	432	438	445	452	458	465
	V1	1161	1186	1211	1236	1261	1286
	H2	631	643	656	668	681	693
CSP 30° + L(1000) + CSP 30°	H1	682	688	695	702	708	715
	V1	1594	1619	1644	1669	1694	1719
	H2	881	893	906	918	931	943
V2		1479	1500	1522	1544	1565	1587

CSP : Codo Simple Pared | Single Wall elbow | Coude Simple Paroi

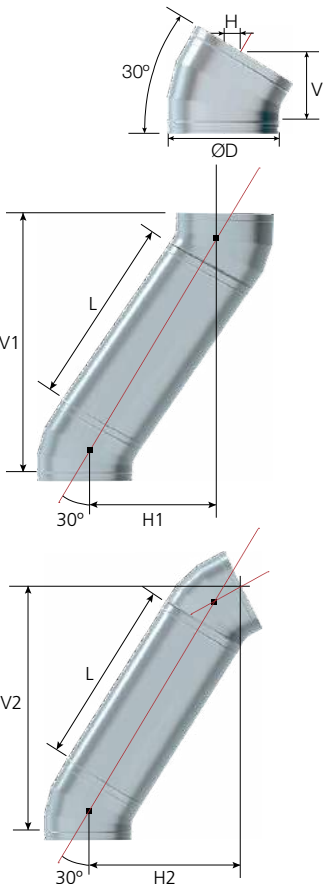

Referencia Reference Référence	Ref.	4029681	Unidad de embalaje Packaging unit Unités par emballage
Precio unidad € Unit price, € Prix unité €	€ U.	166,84 1	

Codo
Elbow
Coude

Codo | Elbow | Coude **45°**

ØD mm	450	500	550	600	650	700
AISI 304	Ref. 4029561	4029681	4029820	4030019	4030109	4040123
€ U.	135,56 1	166,84 1	201,25 1	236,70 1	277,37 1	334,72 1
AISI 316L	Ref. 4029619	4029722	4029870	4030047	4030137	4040127
€ U.	161,63 1	197,08 1	235,66 1	275,29 1	321,17 1	383,73 1

Especificaciones técnicas | Technical specifications | Spécifications techniques

	H	178	185	193	200	207	215
V	367	385	403	420	438	456	

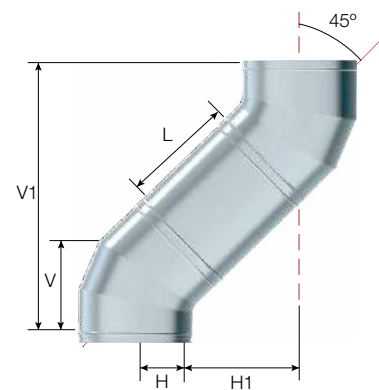
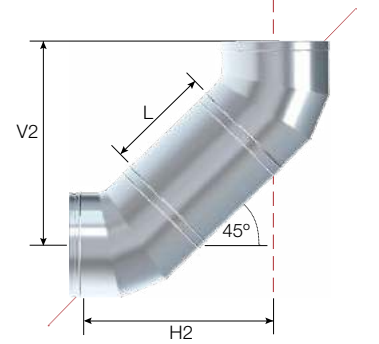
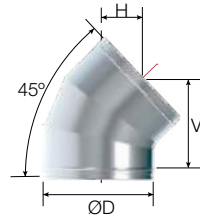

Ø	450	500	550	600	650	700	
CSP 45° + CSP 45°	H1	432	438	445	452	458	465
	V1	1161	1186	1211	1236	1261	1286
	H2	631	643	656	668	681	693
CSP 45° + L(250) + CSP 45°	V2	1046	1067	1089	1111	1132	1154
	H1	682	688	695	702	708	715
	V1	1594	1619	1644	1669	1694	1719
CSP 45° + L(500) + CSP 45°	H2	881	893	906	918	931	943
	V2	1479	1500	1522	1544	1565	1587
	H1	432	438	445	452	458	465
CSP 45° + L(1000) + CSP 45°	V1	1161	1186	1211	1236	1261	1286
	H2	631	643	656	668	681	693
	V2	1046	1067	1089	1111	1132	1154
CSP 45° + L(1500) + CSP 45°	H1	682	688	695	702	708	715
	V1	1594	1619	1644	1669	1694	1719
	H2	881	893	906	918	931	943
V2	1479	1500	1522	1544	1565	1587	

CSP : Codo Simple Pared | Single Wall Elbow | Coude Simple Paroi

Codo | Elbow | Coude **87°**

ØD mm	450	500	550	600	650	700
AISI 316L	Ref. 4029626	4029723	4029897	4030048	4030138	4040128
€ U.	187,21 1	229,89 1	276,45 1	323,01 1	380,24 1	451,95 1

Especificaciones técnicas | Technical specifications | Spécifications techniques

	H	478	502	526	550	573	597
V	456	481	506	531	556	581	

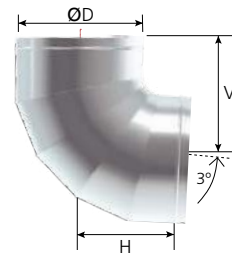

Codo | Elbow | Coude **90°**

ØD mm	450	500	550	600	650	700
AISI 304	Ref. 4029562	4029682	4029821	4030020	4030110	4040124
€ U.	169,75 1	208,55 1	251,23 1	294,88 1	346,29 1	420,01 1

Especificaciones técnicas | Technical specifications | Spécifications techniques

	H	489	514	539	564	589	614
V	440	465	490	515	540	565	

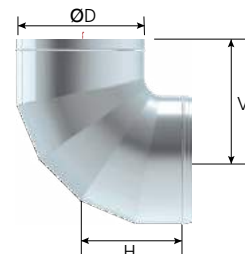

Adaptador
Adapter
Adaptateur

Adaptador caldera | Boiler adapter | Adaptateur chaudière

ØD mm	450	500	550	600	650	700
AISI 304	Ref. 4029554	4029675	4029813	4030013	4030104	4040135
€ U.	64,89 1	79,31 1	97,85 1	117,42 1	140,08 1	169,95 1
AISI 316L	Ref. 4029556	4029703	4029853	4030042	4030127	4040136
€ U.	83,71 1	102,31 1	126,23 1	151,47 1	180,70 1	219,24 1

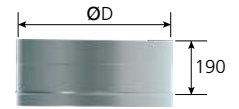

Adaptador SP - DP | SW - DW adapter | Adaptateur SP - DP

ØD mm	450	500	550	600	650	700
AISI 304	Ref. 4029558	4029678	4029817	4030015	4030106	-
€ U.	138,02 1	158,62 1	197,76 1	236,90 1	272,95 1	-
AISI 316L	Ref. 4029616	4029705	4029865	4030044	4030134	-
€ U.	173,04 1	199,82 1	235,87 1	278,10 1	311,06 1	-

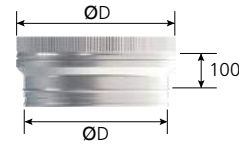

Adaptador Macho - Macho | Male - Male adapter | Adaptateur Mâle - Mâle

ØD mm	450	500	550	600	650	700
AISI 304	Ref. 4040149	4040150	4040151	4040152	4040153	4040154
€ U.	60,81 1	74,89 1	92,34 1	111,49 1	132,32 1	160,47 1
AISI 316L	Ref. 4040155	4040156	4040157	4040158	4040159	4040160
€ U.	81,33 1	99,21 1	123,44 1	148,81 1	176,50 1	214,57 1

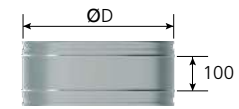

Adaptador Hembra - Hembra | Female - Female adapter | Adaptateur Femelle - Femelle

ØD mm	450	500	550	600	650	700
AISI 304	Ref. 4040137	4040138	4040139	4040140	4040141	4040142
€ U.	57,01 1	70,21 1	86,57 1	104,52 1	124,05 1	150,44 1
AISI 316L	Ref. 4040143	4040144	4040145	4040146	4040147	4040148
€ U.	76,25 1	93,01 1	115,72 1	139,51 1	165,47 1	201,16 1

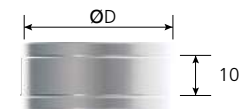

Te y tapa
"T" Piece and cover
Té et tampon

Te | "T" Piece | Té **90° ***

ØD mm	450	500	550	600	650	700
AISI 304	Ref. 4029574	4029697	4029848	4030037	4030122	4040161
€ U.	230,72 1	275,01 1	334,75 1	392,43 1	457,32 1	519,12 1

Especificaciones técnicas | Technical specifications | Spécifications techniques

	L	660	710	760	810	860	910
H	295	320	345	370	395	420	
V	331	356	381	406	431	456	

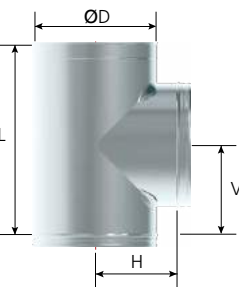

* No incluye tapas | No caps included | Tampons non compris

Te y tapa
"T" Piece and cover
Té et tampon

Te | "T" Piece | Té

93° *



ØD mm		450	500	550	600	650	700
AISI	Ref.	4029642	4029744	4029925	4030064	4030207	4040162
316L	€ U.	272,95	326,51	385,22	452,17	513,97	585,04
Especificaciones técnicas Technical specifications Spécifications techniques							
L		660	710	760	810	860	910
H		307	334	360	386	413	439
V		306	331	356	381	406	431

* No incluye tapas | No caps included | Tampons non compris

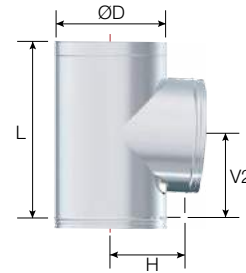

Te | "T" Piece | Té

135° *



ØD mm		450	500	550	600	650	700
AISI	Ref.	4033789	4033790	4033791	4033792	4033793	4040163
304	€ U.	279,82	359,63	446,63	539,39	657,19	762,66
AISI	Ref.	4033794	4033795	4033796	4033797	4033798	4040164
316L	€ U.	335,78	424,36	518,09	614,91	742,63	857,99
Especificaciones técnicas Technical specifications Spécifications techniques							
L		848	898	948	1048	1098	1148
H		464	492	519	583	611	638
V		189	201	213	238	251	263

* No incluye tapas | No caps included | Tampons non compris

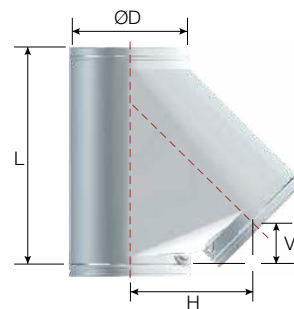

Tapa | Cap | Tampon



ØD mm		450	500	550	600	650	700
AISI	Ref.	4029572	4029695	4029846	4030034	4030120	4040165
304	€ U.	77,25	82,40	88,58	100,94	114,33	132,87
AISI	Ref.	4029635	4029739	4029913	4030057	4030202	4040166
316L	€ U.	93,73	98,88	105,06	119,48	134,93	156,56
Especificaciones técnicas Technical specifications Spécifications techniques							
H		158	184	208	232	257	282

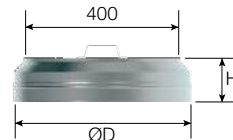

Tapa purga | Condensate cap | Tampon récupérateur condensats



ØD mm		450	500	550	600	650	700
AISI	Ref.	4029571	4029694	4029845	4030033	4030119	4040167
304	€ U.	84,20	89,82	96,55	110,02	124,62	144,83
AISI	Ref.	4029634	4029738	4029905	4030056	4030201	4040168
316L	€ U.	102,17	107,78	114,52	130,23	147,07	170,65
Especificaciones técnicas Technical specifications Spécifications techniques							
H		158	184	208	232	257	282

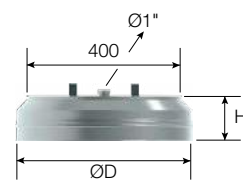

Tapa purga lateral | Lateral condensate cap | Tampon récupérateur condensats latéral



ØD mm		450	500	550	600	650	700
AISI	Ref.	4035165	4035166	4035167	4035168	4035169	4040169
316L	€ U.	136,40	151,80	162,80	189,20	215,60	245,30
Especificaciones técnicas Technical specifications Spécifications techniques							
H		158	184	208	232	257	282

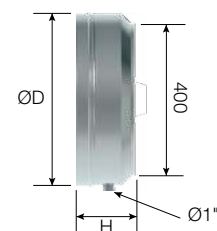

Referencia Reference Référence	Ref.	4029744	Unidad de embalaje Packaging unit Unités par emballage
Precio unidad € Unit price, € Prix unité €	€ U.	326,51	1

Fijación al suelo
Floor fastening
Fixation au sol

1 Tapa condensación | Condensate cap | Tampon récupérateur condensats



ØD mm		450	500	550	600	650	700
AISI	Ref.	4028611	4029740	4029922	4030058	4030203	4040307
316L	€ U.	117,49	123,95	131,69	149,77	169,13	196,25

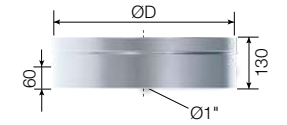

Sifón | Siphon | Siphone



Ref.	4030741
€ U.	29,15

max. 160° C

2 Tubo recortable | Cut-out piping | Élément recoupable



1.000 mm

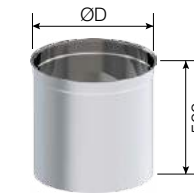

500 mm

L 1.000 mm

ØD mm		450	500	550	600	650	700
AISI	Ref.	4028614	4040400	4040401	4040402	4040403	4040404
304	€ U.	138,38	166,32	201,72	239,48	279,42	333,02

L 500 mm

ØD mm		450	500	550	600	650	700
AISI	Ref.	4040405	4040406	4040407	4040408	4040409	4040410
304	€ U.	83,86	100,80	122,25	145,14	169,34	201,83

3 Base inicial con salida lateral | Floor base with lateral outlet | Plaque de départ avec sortie latérale



ØD mm		450	500	550	600	650	700
AISI	Ref.	4028612	4040412	4040413	4040414	4040415	4040416
304	€ U.	65,23	79,06	95,89	113,84	132,82	158,30

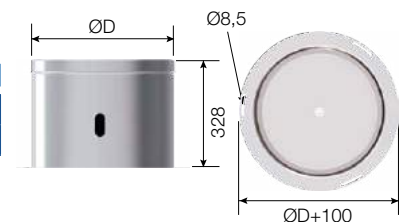

Alternativas de montaje de la base inicial | Alternative floor base mounting | Possibilités de montage de la plaque de départ au sol

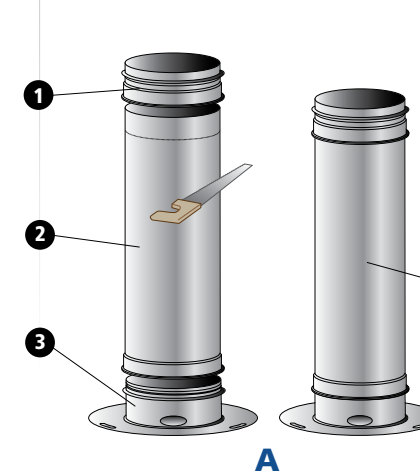

A
Montaje | Mounting | Montage 1
Con tubo recortable
With cut-out piping
Avec tuyau recoupable

El tubo recortable puede ser cortado a medida para que encaje perfectamente entre el suelo y la te de conexión a la caldera.
The cut-out piping can be cut to size for correct fitting between the floor and the boiler connection "T" Piece.
L'élément recoupable peut être coupé sur mesure pour s'emboîter parfaitement entre le sol et le té de raccordement à la chaudière.

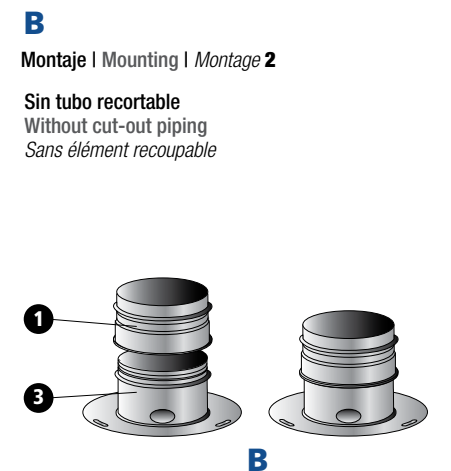

B
Montaje | Mounting | Montage 2
Sin tubo recortable
Without cut-out piping
Sans élément recoupable

Módulo de inspección, purga, base y control de gases
Inspection, purge, base and gas control module
Module d'inspection, purge, base et contrôle du gaz

Módulo de inspección | Inspection module | Module inspection *



ØD mm		450	500	550	600	650	700
AISI	Ref.	4029566	4029685	4029840	4030027	4030113	4040182
304	€ U.	242,26	288,76	351,49	412,05	480,19	545,08
AISI	Ref.	4029629	4029733	4029900	4030051	4030147	4040183
316L	€ U.	286,60	342,84	404,48	474,78	539,67	614,29

* No incluye tapas | No caps included | Tampons non compris



Codo inspección | Inspection elbow | Coude inspection 87° *



ØD mm		450	500	550	600	650	700
AISI	Ref.	4033098	4033099	4033100	4033101	4033102	4040190
316L	€ U.	292,52	350,20	415,09	493,37	547,96	643,75

Especificaciones técnicas | Technical specifications | Spécifications techniques

	H	626	649	673	697	720	744
V	597	622	647	672	697	722	747

* No incluye tapas | No caps included | Tampons non compris

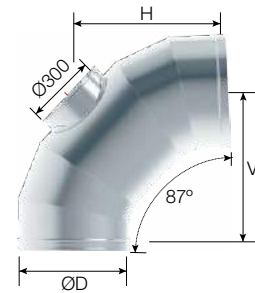

Tapa de inspección | Inspection cover | Trappe d'inspection



Resistente a condensados
Condensate-resistant
Résistante aux condensats

ØD mm		300
Ref.	5003272	
€ U.	63,41	



Para combustibles sólidos
For solid fuels
Pour combustibles solides

ØD mm		300
Ref.	5003398	
€ U.	88,77	

Módulo analizador de gas | Inspection gas control module | Module de contrôle d'inspection de gaz



ØD mm		450	500	550	600	650	700
AISI	Ref.	4040197	4040198	4040199	4040200	4040201	4040202
316L	€ U.	83,51	101,87	126,74	152,80	181,23	220,32

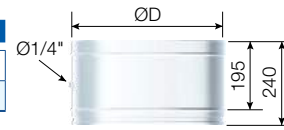

Pirómetro | Pyrometer | Pyromètre



Ref.	2500297
€ U.	21,60

Módulo purga lateral | Lateral purge module | Module récupérateur condensats latérale



ØD mm		450	500	550	600	650	700
AISI	Ref.	4040209	4040210	4040211	4040212	4040213	4040214
316L	€ U.	154,13	171,53	183,96	213,80	243,63	277,19



Referencia Reference Référence	Ref.	4029685	Unidad de embalaje Packaging unit Unités par emballage
Precio unidad € Unit price, € Prix unité €	€ U.	288,76	1

Soporte
Support
Support

Soporte mural intermedio | Intermediate wall support | Support mural intermédiaire



ØD mm		450	500	550	600	650	700
AISI	Ref.	4029570	4029693	4029844	4030032	4030118	4040229
304	€ U.	162,74	199,82	261,62	337,84	443,93	527,36
AISI	Ref.	4029633	4029737	4029904	4030055	4030200	4040230
316L	€ U.	195,29	235,79	303,48	385,14	497,20	580,10

Especificaciones técnicas | Technical specifications | Spécifications techniques

	A	567	617	667	717	767	817
B	613	663	713	763	813	863	

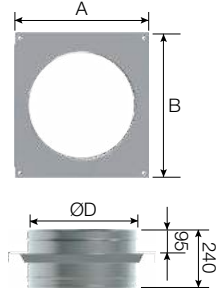

Sombrero
Cap
Chapeau

Sombrero antilluvia | Rain cap | Chapeau pare-pluie



ØD mm		450	500	550	600	650	700
AISI	Ref.	4029567	4029686	4029841	4030028	4030114	4040227
304	€ U.	155,80	197,76	236,90	277,07	330,63	369,77
AISI	Ref.	4029630	4029734	4029901	4030052	4030149	4040228
316L	€ U.	183,84	233,36	274,80	315,86	370,31	406,75

Especificaciones técnicas | Technical specifications | Spécifications techniques

	ØDs	600	650	700	750	800	850
--	-----	-----	-----	-----	-----	-----	-----

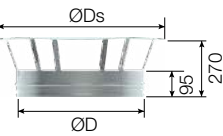

Sombrero antiretorno | Non-return cap | Chapeau anti-refoulement



ØD mm		450	500	550	600	650	700
AISI	Ref.	4040231	4040232	4040233	4040234	4040235	4040236
304	€ U.	199,82	261,62	315,18	389,34	451,14	538,69
AISI	Ref.	4040237	4040238	4040239	4040240	4040241	4040242
316L	€ U.	249,78	319,18	378,22	459,42	523,32	614,11

Especificaciones técnicas | Technical specifications | Spécifications techniques

	ØDp	650	700	750	800	850	900
	ØDd	550	600	650	700	750	800

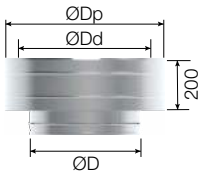

Sombrero salida libre | Outlet cone | Cône de finition



ØD mm		450	500	550	600	650	700
AISI	Ref.	4029569	4029692	4029843	4030030	4030117	4040129
304	€ U.	143,17	168,92	211,15	262,65	330,63	409,94
AISI	Ref.	4029632	4029736	4029903	4030054	4030151	4040130
316L	€ U.	174,67	202,70	249,16	304,67	376,92	459,13

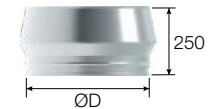

Sombrero bicónico | Biconical cap | Chapeau bicône



ØD mm		450	500	550	600	650	700
AISI	Ref.	4040191	4040192	4040193	4040194	4040195	4040196
304	€ U.	792,00	920,00	1.080,00	1.184,00	1.384,00	1.536,00

Especificaciones técnicas | Technical specifications | Spécifications techniques

	ØDs	540	600	660	720	780	840
	ØDc	790	885	980	1075	1140	1225
	H	867	947	1027	1107	950	1000



Junta
Gasket
Joint

Junta silicona | Silicone gasket | Joint silicone



ØD mm		450	500	550	600	650	700
Ref.	5005716	5005717	5005718	5005719	5005720	5005721	
€ U.	11,85	14,21	16,48	19,06	21,35	23,84	

Lubricante silicona
Silicone lubricant
Graisse silicone



150ml	
Ref.	5002932
€ U.	6,10

Abrazadera
Bracket
Bride, Collier

Abrazadera mural interior | Interior wall bracket | Bride murale intérieure

		ØDe mm					
		450	500	550	600	650	700
AISI 304	Ref.	4035019	4035066	4035067	4035068	4035069	4035070
	€ U.	61,43	71,07	81,86	91,57	104,84	119,62
Especificaciones técnicas Technical specifications Spécifications techniques							
A		503	553	603	653	703	753
B		276	301	326	351	376	401

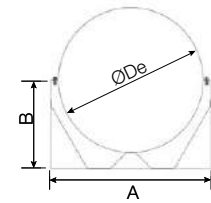

Abrazadera de vientos | Roof brace band | Collier pour hauban

		ØDe mm					
		450	500	550	600	650	700
AISI 304	Ref.	4014608	4014609	4014610	4014611	4014612	4014613
	€ U.	65,71	69,42	72,34	75,65	78,69	80,85

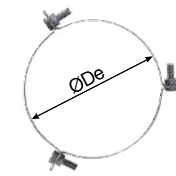

Abrazadera descenso | Chimney-lowering bracket | Collier de descente

		ØDe mm					
		450	500	550	600	650	700
AISI 304	Ref.	4040417	4040418	4040419	4040420	4040421	4040422
	€ U.	55,85	58,54	61,75	65,03	67,42	72,24

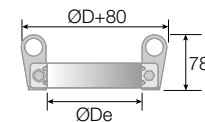

Abrazadera de unión tornillo | Connection bracket, screwed | Collier de fixation à vis

		ØDe mm					
		450	500	550	600	650	700
AISI 304	Ref.	5004828	5004829	5004830	5004831	5004832	5004833
	€ U.	12,56	14,23	16,06	17,86	19,54	21,42

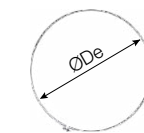

Abrazadera araña | Spider bracket | Bride araignée

		ØDe mm					
		450	500	550	600	650	700
AISI 304	Ref.	4040203	4040204	4040205	4040206	4040207	4040208
	€ U.	48,59	50,93	53,72	56,58	58,66	62,85

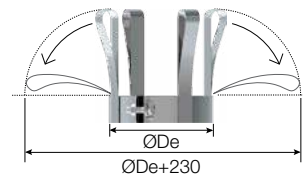

Abrazadera forjado universal | Universal ceiling bracket | Collier support plancher universel

		ØDe mm					
		450	500	550	600	650	700
AISI 304	Ref.	4040131	4040132	4040133	4040134	4040215	4040216
	€ U.	58,65	61,47	64,84	68,28	70,79	75,85

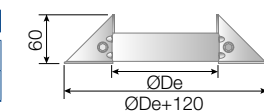

Fijación forjado angular (2 unidades) | Angular forged fixation (2 units) | Fixation angulaire (2 unités)

		1000 mm	
Ref.		4026057	
€ U.		31,62	1

GALVANIZADA
GALVANIZED
GALVANISÉ

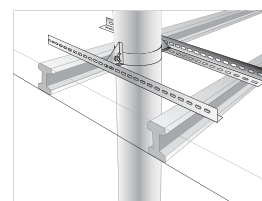

Referencia Référence Référence	Ref.	4035066	Unidad de embalaje Packaging unit Unités par emballage
Precio unidad € Unit price, € Prix unité €	€ U.	71,07	1

Abrazadera
Bracket
Bride, Collier

Soporte a techo regulable | Adjustable ceiling mounting | Support au toit réglable

		ØDe mm					
		450	500	550	600	650	700
AISI 304	Ref.	4040054	4040055	4040056	4040057	4040058	4040059
	€ U.	97,85	100,94	104,03	107,13	110,21	113,30
Especificaciones técnicas Technical specifications Spécifications techniques							
L		955	1005	1055	1105	1155	1205

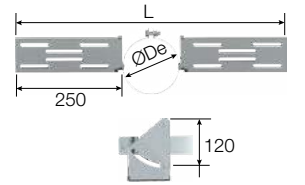

Soporte mural universal | Universal wall support | Support mural universel

		ØDe mm					
		450	500	550	600	650	700
AISI 304	Ref.	4026062	4026063	4026064	4026066	4026067	4026069
	€ U.	176,62	209,61	243,60	271,92	303,64	339,90
Especificaciones técnicas Technical specifications Spécifications techniques							
A		485	535	585	635	685	735
B		565	615	665	715	765	815

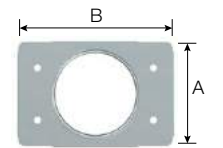

Escuadra reforzada (set 2 unids.) | Reinforced square (set 2 units) | Support renforcé (set 2 unités)

		L		
		500 mm	750 mm	1000 mm
Ref.		5003914	5003915	5003916
	€ U.	141,15	173,25	215,56
Espec. técnicas Technical specif. Spécif. techniques				
H		310	470	600

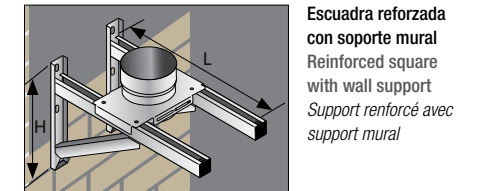

Escuadra reforzada con soporte mural
Reinforced square with wall support
Support renforcé avec support mural

Abrazadera forjado | Ceiling bracket | Collier support plancher

		ØDe mm					
		450	500	550	600	650	700
AISI 304	Ref.	5001475	5001476	5001477	5001478	5001479	5001480
	€ U.	69,62	72,30	74,31	77,50	81,16	83,73

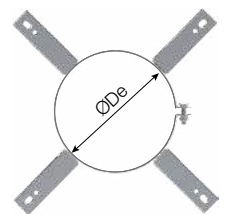

Abrazadera forjado reforzada | Reinforced ceiling bracket | Collier support plancher renforcé

		ØDe mm					
		450	500	550	600	650	700
AISI 304	Ref.	4023226	4026831	4026832	4026833	4026834	4026835
	€ U.	44,29	45,66	48,65	54,14	57,11	60,67
Especificaciones técnicas Technical specifications Spécifications techniques							
A		138	173	173	173	173	173
B		300	350	350	350	350	350

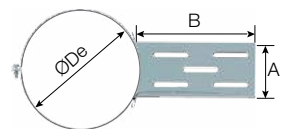

Kit fijación reforzado universal (set 2 unids.) | Universal reinforced fastening kit (set 2 units) | Kit fixation renforcé universel (set 2 unités)

		1000 mm	
Ref.		4026055	
€ U.		45,54	1

GALVANIZADA
GALVANIZED
GALVANISÉ

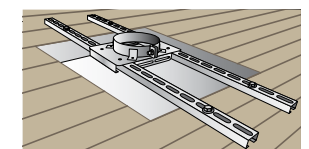

Kit fijación soporte mural universal
Universal wall support kit
Kit support mural universel

1 Apto para Soporte mural universal e intermedio | Suitable for universal and intermediate wall supports | Convient pour le Support mural universel et intermédiaire

3 SPN

Simple Pared negro-mate
Single Wall matt-black
Simple Paroi noir mat

Ø80 - 150

CE Especificaciones de acuerdo a la legislación europea en productos de construcción CPR
Specifications according to EU product regulations of construction CPR
Spécifications Selon la réglementation européenne concernant les produits de construction CPR

AISI 316L
(1.4404) 2R

RAL 9011 Negro mate | Matt-black | Noir Mat HT 600°

EN 1856-2

Ø80-150
T200 P1 W V2 L50040 O(75)M*
T200 N1 W V2 L50040 O(75)M
T600 N1 W V2 L50040 G(800)M

* Para cumplir con esta designación todos los elementos deben estar instalados con juntas, consulte la página 49. Para saber el número de juntas, consulte la página 165.
* To comply with this designation, all elements must be installed with gaskets, see page 49. For the number of joints, see page 165.
* Pour respecter cette désignation, tous les éléments doivent être installés avec des joints, voir page 49. Unités de joints par élément, voir page 165.

Para el resto de elementos, la junta es opcional.
For all other elements, the gasket is optional.
Pour tous les autres éléments, le joint est optionnel.

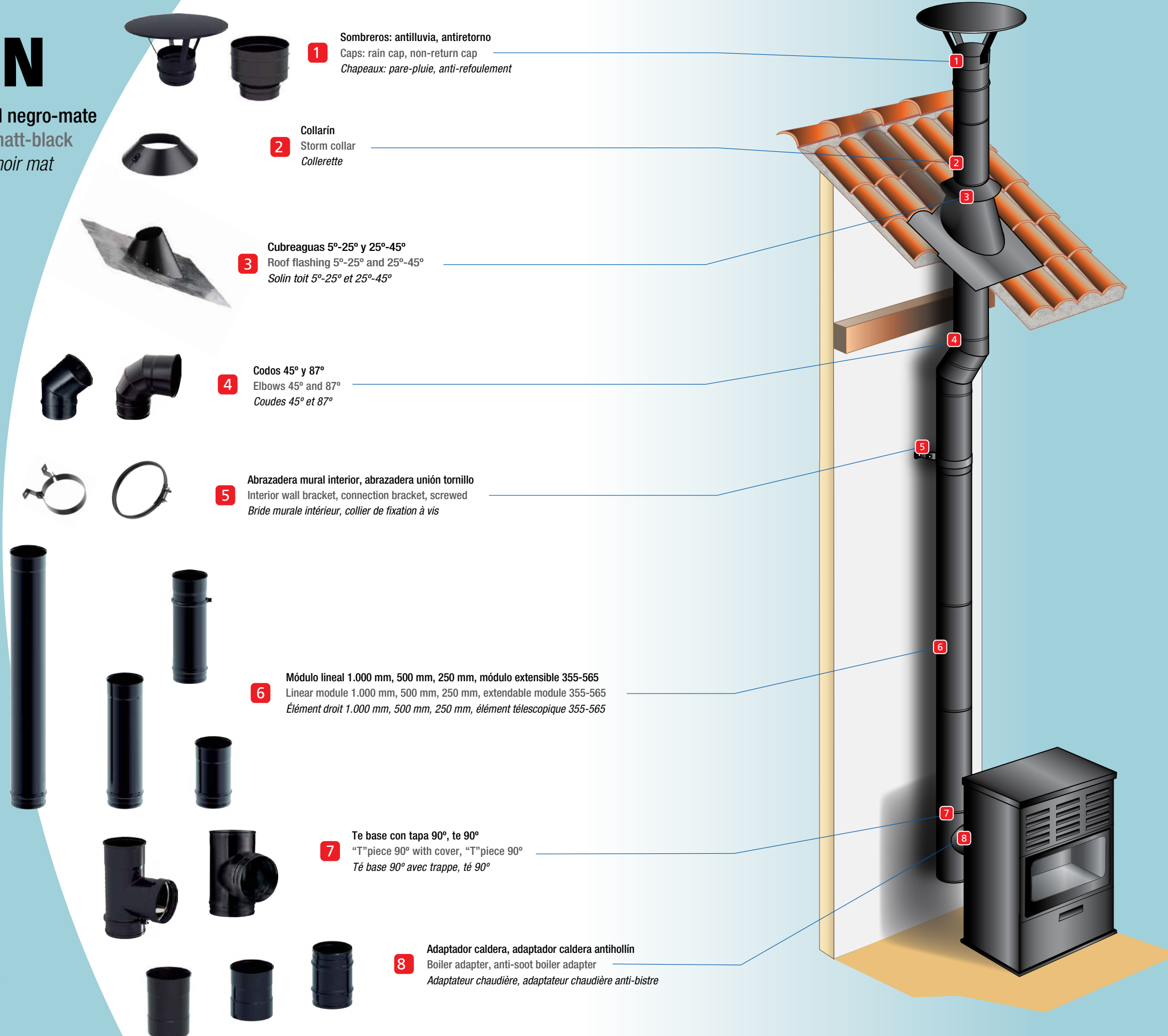

1 Sombreros: antilluvia, antiretorno
Caps: rain cap, non-return cap
Chapeaux: pare-pluie, anti-refoulement

2 Collarín
Storm collar
Collerette

3 Cubreaguas 5°-25° y 25°-45°
Roof flashing 5°-25° and 25°-45°
Solin toit 5°-25° et 25°-45°

4 Codos 45° y 87°
Elbows 45° and 87°
Coudes 45° et 87°

5 Abrazadera mural interior, abrazadera unión tornillo
Interior wall bracket, connection bracket, screwed
Bride murale intérieure, collier de fixation à vis

6 Módulo lineal 1.000 mm, 500 mm, 250 mm, módulo extensible 355-565
Linear module 1.000 mm, 500 mm, 250 mm, extendable module 355-565
Élément droit 1.000 mm, 500 mm, 250 mm, élément télescopique 355-565

7 Te base con tapa 90°, te 90°
"T" piece 90° with cover, "T" piece 90°
Té base 90° avec trappe, té 90°

8 Adaptador caldera, adaptador caldera antihollín
Boiler adapter, anti-soot boiler adapter
Adaptateur chaudière, adaptateur chaudière anti-bistre



Referencia Reference Référence	Ref.	4022859	Unidad de embalaje Packaging unit Unités par emballage
Precio unidad € Unit price, € Prix unité €	€ U.	59,00 1	

Módulo lineal y extensible
Pipe and extendable module
Élément droit et télescopique

Módulo lineal | Pipe | Élément droit



		ØD mm	80	100	125	150
		L 1000 mm				
AISI 316L	Ref.	4022857	4022858	4024235	4022859	
	€ U.	41,30 1	47,20 1	52,27 1	59,00 1	
		L 500 mm				
AISI 316L	Ref.	4022860	4022861	4024237	4022862	
	€ U.	25,96 1	29,50 1	33,63 1	37,17 1	
		L 250 mm				
AISI 316L	Ref.	4022863	4022864	4024236	4022865	
	€ U.	17,11 1	19,47 1	23,01 1	25,37 1	

Módulo extensible | Extendable module | Élément télescopique



		ØD mm	80	100	125	150
		Lmin 355 mm - Lmax 565 mm				
AISI 316L	Ref.	4022866	4022867	4024228	4022868	
	€ U.	46,04 1	52,70 1	58,50 1	65,88 1	

Codo
Elbow
Coude

Codo | Elbow | Coude



		ØD mm	80	100	125	150
45°	AISI 316L	Ref.	4022882	4022883	4024222	4022885
		€ U.	28,06 1	31,55 1	36,58 1	40,12 1
87°	AISI 316L	Ref.	4022886	4022887	4024223	4022888
		€ U.	36,82 1	41,30 1	45,67 1	50,74 1

Adaptador
Adapter
Adaptateur

Adaptador caldera | Boiler adapter | Adaptateur chaudière



		ØD mm	80	100	125	150
AISI 316L	Ref.	4022896	4022898	4024215	4022899	
	€ U.	28,50 1	30,97 1	35,03 1	37,12 1	

Adaptador caldera antihollín | Anti-soot boiler adapter | Adaptateur chaudière anti-bistre



		ØD mm	80	100	125	150
AISI 316L	Ref.	-	4025417	4025418	4025419	
	€ U.	-	34,41 1	38,30 1	41,07 1	

Adaptador hembra-hembra | Double female adapter | Adaptateur femelle-femelle



		ØD mm	80	100	125	150
AISI 316L	Ref.	4022901	4022902	4024214	4022904	
	€ U.	25,24 1	29,36 1	33,45 1	36,57 1	

Analizador
Analyzer
Analyseur

Analizador gas | Gas analyzer | Analyseur de gaz



		ØD mm	80	100	125	150
AISI 316L	Ref.	4027395	4027396	4027405	4027406	
	€ U.	43,70 1	46,00 1	48,30 1	51,75 1	

Te y tapa
"T" Piece and Cover
Té et tampon

Te | "T" Piece | Té 90° *



		ØD mm	80	100	125	150
AISI 316L	Ref.	4022869	4022870	4024234	4022871	
	€ U.	42,75 1	49,50 1	53,25 1	61,85 1	

* No incluye tapas | No caps included | Tampons non compris

Te base con tapa | "T" Piece with cover | Té base avec tampon 90°



		ØD mm	80	100
AISI 316L	Ref.	4024167	4016689	
	€ U.	71,98 1	79,06 1	

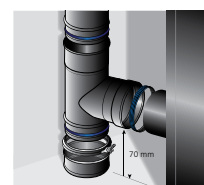

TE BASE | BASE "T" PIECE | TÉ BASE

Tapa | Cover | Tampon

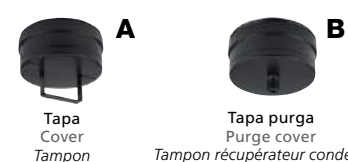

		ØD mm	80	100	125	150
A	AISI 316L	Ref.	4022875	4022878	4024232	4022879
		€ U.	19,45 1	22,48 1	27,13 1	30,23 1
B	AISI 316L	Ref.	4022872	4022873	4024233	4022874
		€ U.	29,45 1	31,78 1	35,65 1	37,98 1

Embellecedor
Sloping roof trim
Plaque de finition

Embellecedor 1 pieza | Trim, 1 piece | Plaque de finition, 1 pièce



		ØD mm	80	100	125	150
AISI 304	Ref.	4015203	4016147	4024200	4015205	
	€ U.	27,46 1	31,73 1	36,45 1	41,85 1	

Embellecedor 2 piezas | Trim, 2 pieces | Plaque de finition, 2 pièces



		ØD mm	80	100	125	150
AISI 304	Ref.	4023250	4023394	4024207	4023395	
	€ U.	32,20 1	35,70 1	41,82 1	49,17 1	

Rosetón | Rosette | Rosace



		ØD mm	80	100	125	150
AISI 304	Ref.	4016074	4016077	4024213	4016148	
	€ U.	28,32 1	30,21 1	33,36 1	36,58 1	

Collarín | Storm collar | Collettere



		ØD mm	80	100	125	150
AISI 304	Ref.	4014679	4016124	4024195	4014753	
	€ U.	32,28 1	36,40 1	40,32 1	43,68 1	

Abrazadera
Bracket
Bride, Collier

Abrazadera mural interior | Interior wall band | Bride murale intérieur



		ØD mm	80	100	125	150
AISI 304	Ref.	4014719	4016109	4024105	4014747	
	€ U.	11,38 1	13,05 1	15,14 1	16,88 1	

Abrazadera unión tornillo | Locking band | Collier verrouillage



		ØD mm	80	100	125	150
AISI 304	Ref.	4022253	4022260	4027141	4022263	
	€ U.	5,40 1	5,74 1	6,30 1	6,86 1	

Cubreaguas
Roof flashing
Solin

Cubreaguas plomo | Lead roof flashing | Solin plomb 5° - 25°



		ØD mm	80	100	125	150
AISI 304	Ref.	4014680	4016122	4024198	4014754	
	€ U.	172,42 1	185,25 1	205,84 1	221,98 1	

Cubreaguas plomo | Lead roof flashing | Solin plomb 25° - 45°



		ØD mm	80	100	125	150
AISI 304	Ref.	4024245	4016123	4024199	4020736	
	€ U.	177,37 1	190,95 1	210,90 1	228,95 1	

Sombrero
Cap
Chapeau

Sombrero antiretorno | Non-return cap | Chapeau anti-refoulement



		ØD mm	80	100	125	150
AISI 316L	Ref.	4022889	4022890	4024231	4022892	
	€ U.	78,41 1	87,43 1	99,66 1	114,29 1	

Sombrero antilluvia | Rain cap | Chapeau pare-pluie



		ØD mm	80	100	125	150
AISI 316L	Ref.	4022893	4022894	4024230	4022895	
	€ U.	53,89 1	58,60 1	63,60 1	72,02 1	

Junta
Gasket
Joint

Junta silicona | Silicone gasket | Joint silicone



		80	100	125	150
Ref.		5003948	5003950	5003951	5003952
	€ U.	1,00 10	1,09 10	1,38 10	1,83 10

Aumento excéntrico | Eccentric Augmentation adapter | Augmentation excentrée

Ø	80	100	125	150
100	Ref. 4022920			
€	51,92			
130	Ref. 4022921	4022923	4024217	
€	55,46	58,91	60,18	
150	Ref. 4022922	4022924	4024218	
€	59,08	60,18	61,36	
180	Ref.			4022925
€				74,34
200	Ref.			4022926
€				76,70

L = Longitud (mm) Reducción y cónica eficaz ensanchamiento (15°) a la pared individual
L = Length (mm) Reduction and effective conical enlargement (15°) to Single wall
L = Longueur (mm) Réduction et l'élargissement conique efficace (15°) à Simple paroi

ØDi mm	80	100	125	150
100	121			
130	147	129	147	
150	164	147	125	
180				128
200				145

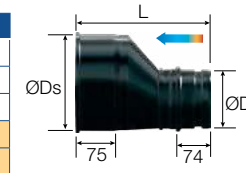

Spray Reparación | Repair spray

Spray réparation 400 ml NG HT



senotherm®

Ref.	5006097
€ U.	24,64 1

4 Fi

Fumistería inoxidable
Stainless steel connecting flue pipe
Fumisterie inoxydable

Ø80 - 400

- 

1 Sombrero antilluvia "Seta", sombrero antiretorno "Cerco"
"Seta" rain cap, "Cerco" antireturn cap
Chapeau pare-pluie "Seta", chapeau antirrefoulement "Cerco"
- 

2 Abrazadera alicatar, Abrazadera empotrar
Wall mounting bracket, Bracket with Leg
Collier à vis, Collier à encastrer
- 

3 Tubo 1.000 mm y 500 mm
Pipe 1.000 mm and 500 mm
Conduit 1.000 mm et 500 mm
- 

4 Codo 45° y 90°
Elbow 45° and 90°
Coude 45° et 90°
- 

5 Te 90° con tapa
"T" piece 90° with cover
Té 90° avec tampon
- 

6 Manguito Macho-Macho, Hembra-Hembra
Connection hose Male-Male, Female-Female
Manchette de raccordement Mâle-Mâle, Femelle-Femelle
- 

7 Reducción
Reduction adapter
Adaptateur chaudière

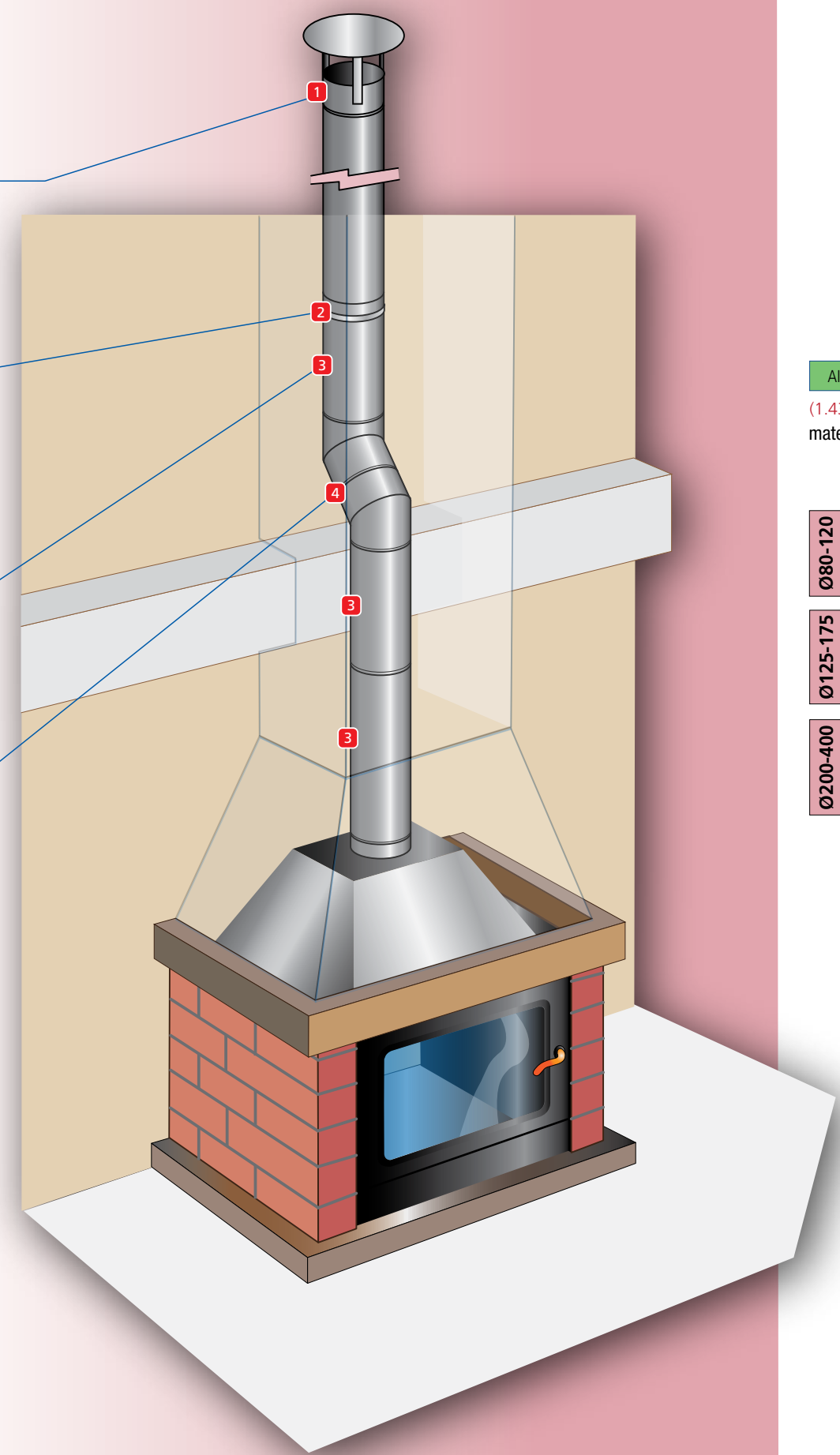

CE Especificaciones de acuerdo a la legislación europea en productos de construcción CPR
Specifications according to EU product regulations of construction CPR
Spécifications Selon la réglementation européenne concernant les produits de construction CPR

AISI 304L
(1.4307) 2B
mate | matt | mat

EN 1856-2

Ø80-120	T600 N1 D Vm L20040 G(600) NM
Ø125-175	T600 N1 D Vm L20050 G(600) NM T600 N1 D Vm L20060 G(600) NM
Ø200-400	T600 N1 D Vm L20080 G(600) NM



Referencia Reference Référence	Ref.	5301150	Unidad de embalaje Packaging unit Unités par emballage
Precio unidad € Unit price, € Prix unité €	€ U.	16,05 7	

Diámetro diameter diamètre Ø	Espesor Sheet thickness Épaisseur paroi	Ref.	80	100	120	125	130	150	175
			0,4			0,5			
Tubo Pipe Conduit 1.000 mm		Ref. € U.	5301080 11,85 10	5301100 13,60 10	5301120 14,15 10	5301125 14,45 10	5301130 15,05 10	5301150 16,05 7	5301175 19,65 5
Tubo Pipe Conduit 500 mm		Ref. € U.	5302080 7,65 10	5302100 8,80 10	5302120 9,20 10	5302125 9,25 10	5302130 9,65 10	5302150 9,95 5	5302175 12,20 5
Codo rizado Ridged Elbow Coude plissé 45°		Ref. € U.	5311080 7,85 8	5311100 8,05 8	5311120 8,30 8	5311125 8,35 8	5311130 8,60 8	5311150 8,95 8	5311175 10,90 8
Codo rizado Ridged Elbow Coude plissé 90°		Ref. € U.	5313080 11,65 4	5313100 12,05 4	5313120 13,15 4	5313125 13,25 4	5313130 13,70 4	5313150 14,20 4	5313175 16,45 4
Te 90° con tapa "T" piece 90° with Cover Té 90° avec tampon		Ref. € U.			5321120 47,85 1	5321125 48,80 1	5321130 50,20 1	5321150 51,95 1	5321175 60,25 1
Sombrero antilluvia "Seta" "Seta" Rain Cap Chapeau pare-pluie "Seta"		Ref. € U.	5332080 26,95 1	5332100 29,85 1	5332120 35,25 1	5332125 36,45 1	5332130 36,85 1	5332150 37,95 1	5332175 43,15 1
Sombrero antiretorno "Cercos" "Cercos" Antireturn Cap Chapeau anti-refoulement "Cercos"		Ref. € U.	5433080 40,60 1	5433100 42,30 1	5433120 44,35 1	5433125 48,05 1	5433130 49,35 1	5433150 55,15 1	5433175 62,50 1
Abrazadera alicatar Wall mounting bracket Collier à vis		Ref. € U.	5471080 9,70 1	5471100 9,80 1	5471120 9,90 1	5471125 9,95 1	5471130 10,25 1	5471150 10,90 1	5471175 11,75 1
Abrazadera empotrar Bracket with Leg Collier à encastrer		Ref. € U.	5472080 7,45 1	5472100 7,55 1	5472120 7,65 1	5472125 8,00 1	5472130 8,30 1	5472150 9,20 1	5472175 10,30 1
Manguito Macho-Macho Connection hose Male-Male Manchette de raccordement Mâle-Mâle 200 mm		Ref. € U.	5351080 6,85 1	5351100 7,90 1	5351120 8,25 1	5351125 8,30 1	5351130 8,60 1	5351150 8,90 1	5351175 10,95 1
Manguito Hembra-Hembra Connection hose Female-Female Manchette de raccordement Femelle-Femelle 200 mm		Ref. € U.	5352080 6,85 1	5352100 7,90 1	5352120 8,25 1	5352125 8,30 1	5352130 8,60 1	5352150 8,90 1	5352175 10,95 1
Reducción Reduction Adapter Réduction Ø 125		Ref.			5441120				
€ U.				23,20 1					
Ref.				5442120	5442125				
€ U.				26,55 1	27,35 1				
Ref.				5443120	5443125	5443130			
€ U.			27,15 1	28,25 1	29,05 1				
Reducción Reduction Adapter Réduction Ø 175		Ref. € U.						5444150 31,45 1	
Reducción Reduction Adapter Réduction Ø 200		Ref. € U.						5445150 34,20 1	5445175 35,60 1

Diámetro diameter diamètre Ø	Espesor Sheet thickness Épaisseur paroi	Ref.	200	225	250	300	350	400
			0,8					
Tubo Pipe Conduit 1.000 mm		Ref. € U.	5401200 36,20 4	5401225 47,60 4	5401250 50,85 3	5401300 69,80 3	5401350 81,20 1	5401400 94,65 1
Tubo Pipe Conduit 500 mm		Ref. € U.	5402200 21,95 4	5402225 28,55 4	5402250 29,50 3	5402300 40,50 3	5402350 46,30 1	5402400 53,00 1
Codo Elbow Coude 45°		Ref. € U.	5415200 30,75 8	5415225 35,35 8	5415250 40,90 8	5415300 62,40 8	5415350 75,45 8	5415400 89,70 8
Codo Elbow Coude 90°		Ref. € U.	5416200 43,30 4	5416225 52,05 4	5416250 59,75 4	5416300 87,85 4	5416350 104,80 4	5416400 123,45 4
Te 90° con tapa "T" piece 90° with Cover Té 90° avec tampon		Ref. € U.	5421200 86,85 1		5421250 123,70 1	5421300 159,85 1		
Sombrero antilluvia "Seta" "Seta" Rain Cap Chapeau pare-pluie "Seta"		Ref. € U.	5432200 54,55 1	5432225 73,50 1	5432250 83,15 1	5432300 106,25 1	5432350 145,20 1	5432400 163,65 1
Sombrero antiretorno "Cercos" "Cercos" Antireturn Cap Chapeau anti-refoulement "Cercos"		Ref. € U.	5433200 72,75 1	5433225 94,85 1	5433250 105,15 1	5433300 141,45 1	5433350 217,80 1	5433400 273,95 1
Abrazadera alicatar Wall mounting Bracket Collier à vis		Ref. € U.	5471200 13,15 1	5471225 16,95 1	5471250 20,60 1	5471300 24,65 1	5471350 33,50 1	5471400 43,35 1
Abrazadera empotrar Bracket with Leg Collier à encastrer		Ref. € U.	5472200 11,75 1	5472225 14,95 1	5472250 17,75 1	5472300 21,05 1	5472350 27,80 1	5472400 36,75 1
Manguito Macho-Macho Connection hose Male-Male Manchette de raccordement Mâle-Mâle 200 mm		Ref. € U.	5451200 19,75 1					
Manguito Hembra-Hembra Connection hose Female-Female Manchette de raccordement Femelle-Femelle 200 mm		Ref. € U.	5452200 19,75 1					
Reducción Reduction Adapter Réduction Ø 225		Ref. € U.	5441200 36,90 1					
Reducción Reduction Adapter Réduction Ø 250		Ref. € U.	5442200 39,05 1					
Reducción Reduction Adapter Réduction Ø 300		Ref. € U.			5443250 52,20 1			
Reducción Reduction Adapter Réduction Ø 350		Ref. € U.				5444300 64,85 1		
Reducción Reduction Adapter Réduction Ø 400		Ref. € U.					5445350 82,45 1	

5 FG

Fumistería galvanizada
Galvanized connecting flue pipe
Fumisterie galvanisé

Ø80 - 400

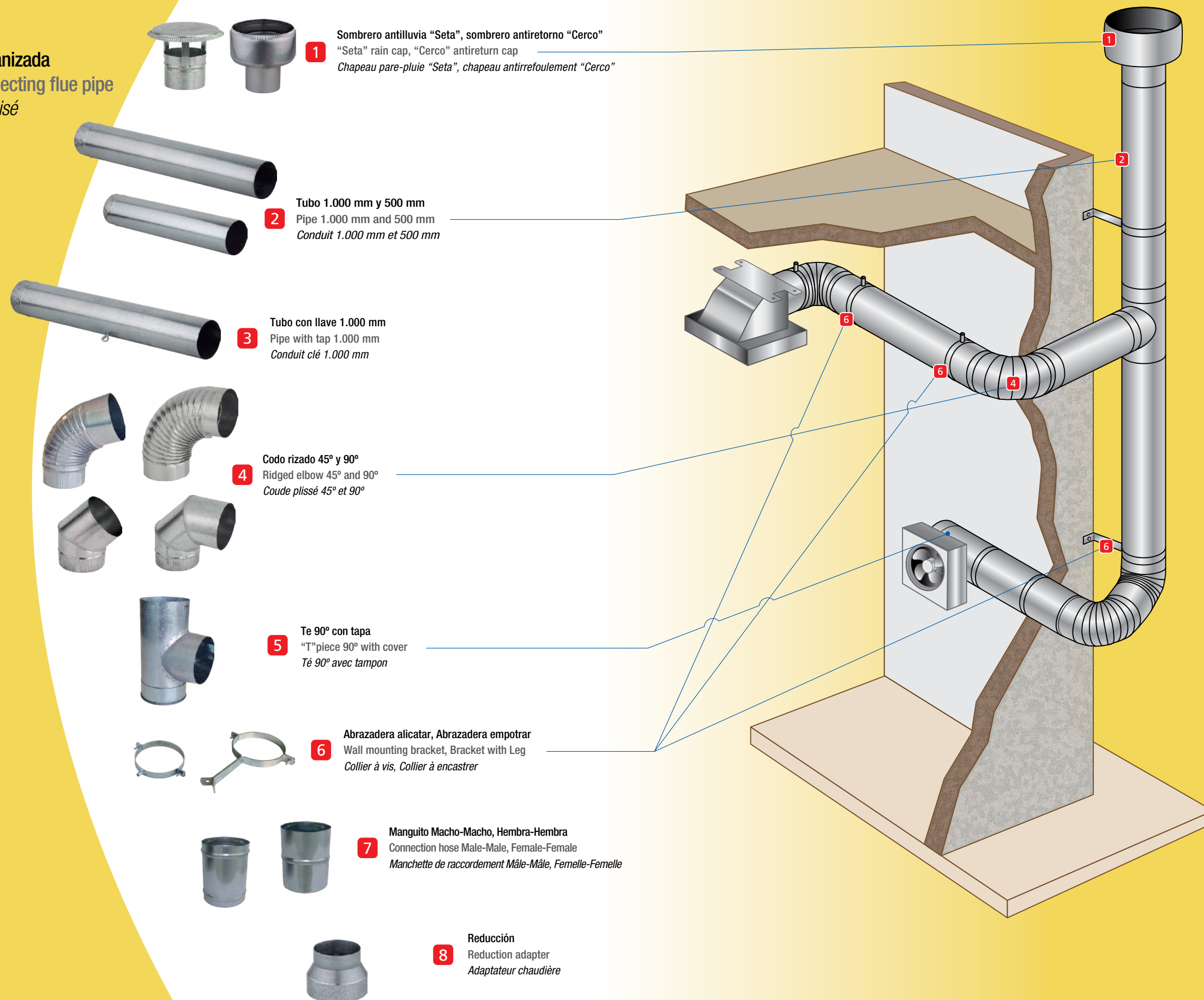

1 Sombrero antilluvia "Seta", sombrero antiretorno "Cerco"
"Seta" rain cap, "Cerco" antireturn cap
Chapeau pare-pluie "Seta", chapeau antirrefoulement "Cerco"

2 Tubo 1.000 mm y 500 mm
Pipe 1.000 mm and 500 mm
Conduit 1.000 mm et 500 mm

3 Tubo con llave 1.000 mm
Pipe with tap 1.000 mm
Conduit clé 1.000 mm

4 Codo rizado 45° y 90°
Ridged elbow 45° and 90°
Coude plissé 45° et 90°

5 Te 90° con tapa
"T" piece 90° with cover
Té 90° avec tampon

6 Abrazadera alicatar, Abrazadera empotrar
Wall mounting bracket, Bracket with Leg
Collier à vis, Collier à encastrer

7 Manguito Macho-Macho, Hembra-Hembra
Connection hose Male-Male, Female-Female
Manchette de raccordement Mâle-Mâle, Femelle-Femelle

8 Reducción
Reduction adapter
Adaptateur chaudière

GALVA

DX51D+Z200-100 MA C

Espesor | Thickness range | *Épaisseur paroi*

Ø80-100	0,4 mm
Ø110-150	0,5 mm
Ø120-175	0,8 mm
Ø200-400	1,0 mm



Referencia Reference Référence	Ref.	5101150	Unidad de embalaje Packaging unit Unités par emballage
Precio unidad € Unit price, € Prix unité €	€ U.	11,05 7	

Diámetro diameter diamètre Ø		80	100	110	120	125	130	140	150	
Espesor Sheet thickness Épaisseur paroi		0,4		0,5						
Tubo Pipe Conduit 1.000 mm		Ref. 5101080	5101100	5101110	5101120	5101125	5101130	5101140	5101150	
		€ U.	7,30 10	8,10 10	8,65 10	9,00 10	9,40 10	9,75 10	10,70 7	11,05 7
Codo rizado Ridged Elbow Coude plissé 45°		Ref. 5111080	5111100	5111110	5111120	5111125	5111130	5111140	5111150	
		€ U.	4,95 8	5,55 8	5,75 8	5,90 8	6,85 8	7,35 8	7,85 8	8,20 8
Codo rizado Ridged Elbow Coude plissé 70°		Ref. 5112080	5112100	5112110	5112120	5112125	5112130	5112140	5112150	
		€ U.	5,40 5	6,00 5	6,25 5	6,40 5	7,45 5	7,95 5	8,50 5	9,00 5
Codo rizado Ridged Elbow Coude plissé 90°		Ref. 5113080	5113100	5113110	5113120	5113125	5113130	5113140	5113150	
		€ U.	5,40 4	6,00 4	6,25 4	6,40 4	7,45 4	7,95 4	8,50 4	9,00 4
Te 90° con tapa "T" piece 90° with Cover Tê 90° avec tampon		Ref.		5121110	5121120					
		€ U.		24,40 1	24,90 1					
Sombrero antilluvia "Seta" "Seta" Rain Cap Chapeau pare-pluie "Seta"		Ref. 5132080	5132100	5132110	5132120	5132125	5132130	5132140	5132150	
		€ U.	13,70 1	14,05 1	14,80 1	15,20 1	16,35 1	16,50 1	18,00 1	19,20 1
Sombrero antiretorno "Cercos" "Cercos" Antireturn Cap Chapeau anti-refoulement "Cercos"		Ref. 5233080	5233100	5233110	5233120	5233125	5233130	5233140	5233150	
		€ U.	36,45 1	36,85 1	37,75 1	38,55 1	41,75 1	42,90 1	44,50 1	47,95 1
Abrazadera alicatar Wall mounting Bracket Collier à vis		Ref. 5271080	5271100	5271110	5271120	5271125	5271130	5271140	5271150	
		€ U.	7,45 1	7,55 1	7,80 1	8,10 1	8,30 1	8,65 1	9,00 1	9,20 1
Abrazadera empotrar Bracket with Leg Collier à encastrer		Ref. 5272080	5272100	5272110	5272120	5272125	5272130	5272140	5272150	
		€ U.	5,70 1	5,75 1	5,90 1	5,95 1	6,40 1	6,80 1	7,20 1	7,60 1
Manguito Macho-Macho Connection hose Male-Male Manchette de raccordement Mâle-Mâle 200 mm		Ref. 5151080	5251100	5151110	5151120	5151125	5151130	5151140	5151150	
		€ U.	6,15 1	7,10 1	7,40 1	7,55 1	7,75 1	7,90 1	8,05 1	8,15 1
Manguito Hembra-Hembra Connection hose Female-Female Manchette de raccordement Femelle-Femelle 200 mm		Ref. 5152080	5252100	5152110	5152120	5152125	5152130	5152140	5152150	
		€ U.	6,15 1	7,10 1	7,40 1	7,55 1	7,75 1	7,90 1	8,05 1	8,15 1
Reducción Reduction Adapter Réduction Ø 100		Ref. 5241080								
		€ U.	12,00 1							
Reducción Reduction Adapter Réduction Ø 110		Ref.		5242100						
		€ U.		12,20 1						
Reducción Reduction Adapter Réduction Ø 120		Ref.		5243100	5243110					
		€ U.		12,55 1	13,10 1					
Reducción Reduction Adapter Réduction Ø 125		Ref.			5244120					
		€ U.			13,50 1					
Reducción Reduction Adapter Réduction Ø 130		Ref.			5245120					
		€ U.			13,90 1					
Reducción Reduction Adapter Réduction Ø 140		Ref.			5246110	5246120				
		€ U.			14,20 1	14,30 1				
Reducción Reduction Adapter Réduction Ø 150		Ref.			5242120					
		€ U.			14,95 1					

Diámetro diameter diamètre Ø		120	125	130	150	175	200	225	250	300	350	400	
Espesor Sheet thickness Épaisseur-paroi		0,8						1,0					
Tubo Pipe Conduit 1.000 mm		Ref. 5201120	5201125	5201130	5201150	5201175	5201200	5201225	5201250	5201300	5201350	5201400	
		€ U.	13,95 10	14,45 5	15,50 5	16,90 5	19,85 5	24,50 4	28,95 4	30,95 3	37,75 3	42,10 1	49,25 1
Codo Elbow Coude 45°		Ref. 5215120	5215125	5215130	5215150	5215175	5215200	5215225	5215250	5215300	5215350	5215400	
		€ U.	16,55 8	17,60 8	17,95 8	19,90 8	22,55 8	27,40 8	29,85 8	31,70 8	41,85 8	56,95 8	70,85 8
Codo Elbow Coude 90°		Ref. 5216120	5216125	5216130	5216150	5216175	5216200	5216225	5216250	5216300	5216350	5216400	
		€ U.	20,25 4	21,35 4	22,40 4	24,70 4	28,85 4	35,50 4	38,80 4	40,85 4	60,25 4	76,70 4	97,20 4
Te 90° con tapa "T" piece 90° with Cover Tê 90° avec tampon		Ref.			5221150	5221175	5221200						
		€ U.			39,70 1	50,20 1	69,75 1						
Sombrero antilluvia "Seta" "Seta" Rain Cap Chapeau pare-pluie "Seta"		Ref. 5232120	5232125	5232130	5232150	5232175	5232200	5232225	5232250	5232300	5232350	5232400	
		€ U.	30,65 1	31,70 1	32,05 1	33,00 1	37,50 1	47,40 1	63,90 1	72,30 1	92,40 1	126,25 1	142,30 1
Sombrero antiretorno "Cercos" "Cercos" Antireturn Cap Chapeau anti-refoulement "Cercos"		Ref. 5233120	5233125	5233130	5233150	5233175	5233200	5233225	5233250	5233300	5233350	5233400	
		€ U.	38,55 1	41,75 1	42,90 1	47,95 1	54,35 1	63,25 1	82,45 1	91,40 1	123,00 1	189,40 1	238,20 1
Abrazadera alicatar Wall mounting Bracket Collier à vis		Ref. 5271120	5271125	5271130	5271150	5271175	5271200	5271225	5271250	5271300	5271350	5271400	
		€ U.	8,10 1	8,30 1	8,65 1	9,20 1	10,10 1	11,75 1	13,25 1	14,80 1	17,20 1	22,45 1	32,55 1
Abrazadera empotrar Bracket with Leg Collier à encastrer		Ref. 5272120	5272125	5272130	5272150	5272175	5272200	5272225	5272250	5272300	5272350	5272400	
		€ U.	5,95 1	6,40 1	6,80 1	7,60 1	8,55 1	9,85 1	10,90 1	12,30 1	14,45 1	19,20 1	28,40 1
Manguito Macho-Macho Connection hose Male-Male Manchette de raccordement Mâle-Mâle 200 mm		Ref. 5251120	5251125	5251130	5251150	5251175	5251200						
		€ U.	9,80 1	10,15 1	10,85 1	11,85 1	13,90 1	17,15 1					
Manguito Hembra-Hembra Connection hose Female-Female Manchette de raccordement Femelle-Femelle 200 mm		Ref. 5252120	5252125	5252130	5252150	5252175	5252200						
		€ U.	9,80 1	10,15 1	10,85 1	11,85 1	13,90 1	17,15 1					
Reducción Reduction Adapter Réduction Ø 125		Ref. 5240120											
		€ U.	13,50 1										
Reducción Reduction Adapter Réduction Ø 130		Ref. 5241120											
		€ U.	13,90 1										
Reducción Reduction Adapter Réduction Ø 150		Ref. 5242120			5242130								
		€ U.	14,95 1		15,25 1								
Reducción Reduction Adapter Réduction Ø 175		Ref.			5243150								
		€ U.			22,85 1								
Reducción Reduction Adapter Réduction Ø 200		Ref.			5244150	5244175							
		€ U.			30,05 1	31,40 1							
Reducción Reduction Adapter Réduction Ø 225		Ref.					5245200						
		€ U.					37,55 1						
Reducción Reduction Adapter Réduction Ø 250		Ref.					5246200						
		€ U.					39,95 1						
Reducción Reduction Adapter Réduction Ø 300		Ref.						5247250					
		€ U.						49,05 1					
Reducción Reduction Adapter Réduction Ø 350		Ref.								5248300			
		€ U.								72,30 1			
Reducción Reduction Adapter Réduction Ø 400		Ref.									5249350		
		€ U.									89,55 1		

6

Fv

Fumistería vitrificada

Vitreous enamel connecting flue pipe

Fumisterie émaillée

Ø120-200

(mate | matt | mat)

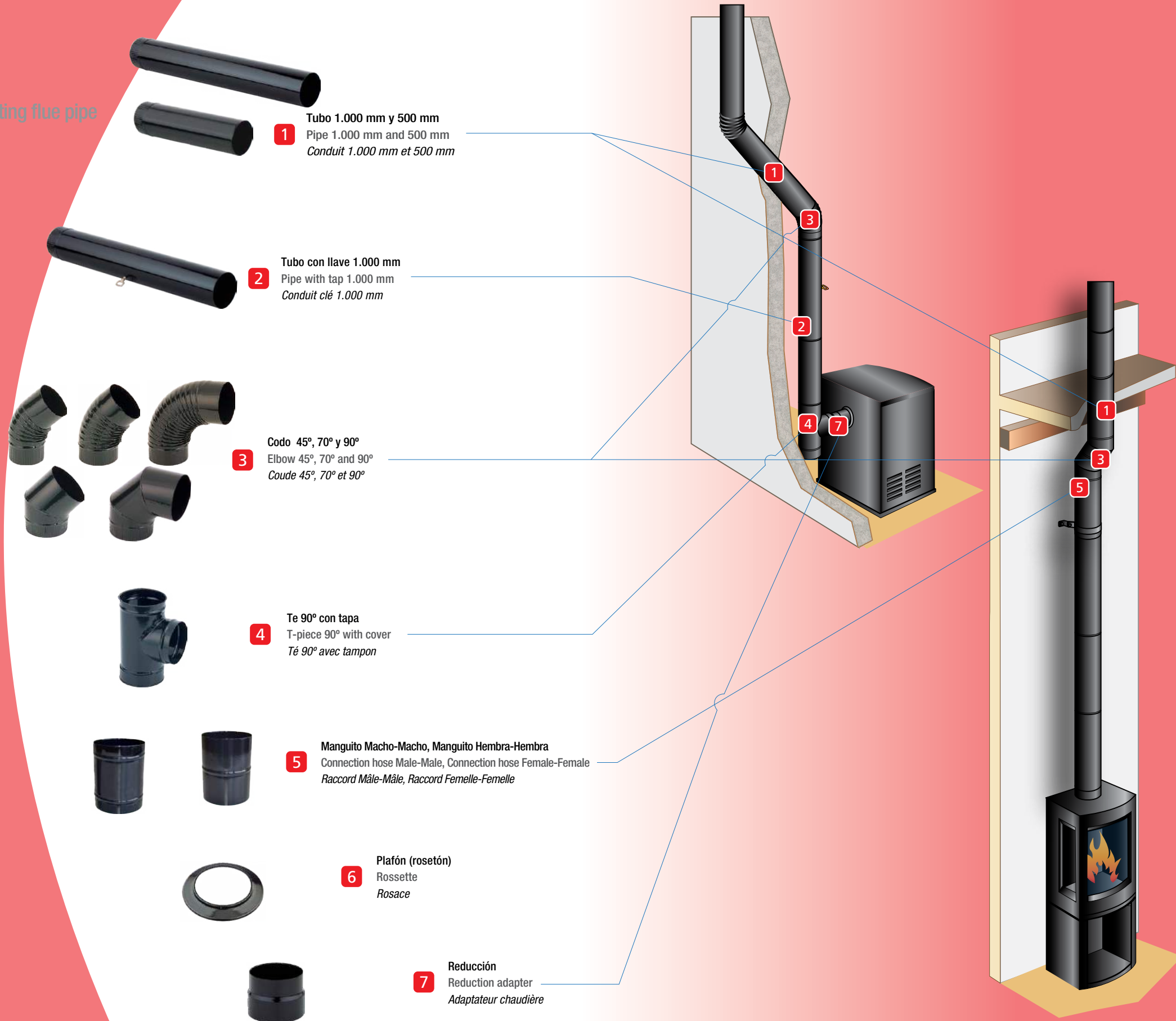

CE Especificaciones de acuerdo a la legislación europea en productos de construcción CPR
Specifications according to EU product regulations of construction CPR
Spécifications Selon la réglementation européenne concernant les produits de construction CPR

VITRI-B



brillante | bright | brillant

EN 1856-2

Ø100-200

T600 N2 D Vm L80050 O(600) NM
T600 N2 D Vm L80080 O(600) NM

VITRI-M



mate | matt | mat

EN 1856-2

Ø120-200

T600 N2 D Vm L80080 O(600) NM

Ø100-200

(brillante | bright | brillant)



Referencia Reference Référence	Ref.	5101150	Unidad de embalaje Packaging unit Unités par emballage
Precio unidad € Unit price, € Prix unité €	€ U.	21,30 3	

Gama negro brillante | Bright black range | Gamme noir brillant

VITRIFICADO A 900°		900° VITRIFIED		VITRIFIÉ À 900°					
Diámetro / diameter / diamètre Ø		100	110	120	150	175	200		
Espesor total / Total thickness / Épaisseur total		1					1,2		
Tubo Pipe Conduit 1.000 mm		Ref. € U.	5501100 16,50 6	5501110 17,10 6	5501120 18,05 6	5501150 21,30 3	5501175 31,95 2	5501200 36,30 2	
Tubo Pipe Conduit 500 mm		Ref. € U.	5502100 13,45 12	5502110 14,10 12	5502120 15,00 12	5502150 16,75 6	5502175 24,95 4	5502200 29,20 4	
Tubo con llave Pipe with Tap Conduit clé 1.000 mm		Ref. € U.	5505100 26,10 6	5505110 26,85 6	5505120 28,10 6	5505150 33,20 3	5505175 49,60 2	5505200 56,25 2	
Codo rizado Ridged Elbow Coude plissé 45°		Ref. € U.	5511100 10,85 15	5511110 11,15 15	5511120 11,50 15	5511150 14,65 10	5515175 * 23,20 10	5515200 * 30,05 10	
Codo rizado Ridged Elbow Coude plissé 70°		Ref. € U.	5512100 11,75 15	5512110 12,15 15	5512120 12,55 15	5512150 16,10 10			
Codo rizado Ridged Elbow Coude plissé 90°		Ref. € U.	5513100 11,75 12	5513110 12,15 12	5513120 12,55 12	5513150 16,10 8	5516175 * 29,40 8	5516200 * 37,40 8	
Te 90° con tapa "T" piece 90° with Cover Té 90° avec tampon		Ref. € U.	5521100 29,70 12	5521110 30,60 10	5521120 31,05 10	5521150 41,80 6	5521175 55,80 4	5521200 77,25 4	
Plafón (rosetón) Rosette Rosace		Ref. € U.	5561100 9,30 1	5561110 9,30 1	5561120 9,50 1	5561150 11,40 1	5561175 13,65 1	5561200 14,85 1	
Manguito Macho-Macho Connection hose Male-Male Manchette de raccordement Mâle-Mâle 200 mm		Ref. € U.	5551100 11,30 1	5551110 11,40 1	5551120 11,50 1	5551150 13,05 1	5551175 15,20 1	5551200 22,85 1	
Manguito Hembra-Hembra Connection hose Female-Female Manchette de raccordement Femelle-Femelle 200 mm		Ref. € U.	5552100 11,30 1	5552110 11,40 1	5552120 11,50 1	5552150 13,05 1	5552175 15,20 1	5552200 22,85 1	
Reducción Reduction Adapter Réduction Ø 110		Ref. € U.	5541100 15,05 1						
Reducción Reduction Adapter Réduction Ø 120		Ref. € U.	5542100 15,20 1	5542110 15,40 1					
Reducción Reduction Adapter Réduction Ø 140		Ref. € U.			5543120 17,65 1				
Reducción Reduction Adapter Réduction Ø 150		Ref. € U.			5544120 19,60 1				
Reducción Reduction Adapter Réduction Ø 175		Ref. € U.				5545150 25,60 1			
Reducción Reduction Adapter Réduction Ø 200		Ref. € U.				5546150 32,95 1	5546175 35,50 1		

Gama negro mate | Black matt range | Gamme noir mat

VITRIFICADO A 900°C		900°C VITRIFIED		VITRIFIÉ À 900°C					
Diámetro / diameter / diamètre Ø		120	125	150	175	200			
Espesor total / Total thickness / Épaisseur total		1,2							
Tubo Pipe Conduit 1.000 mm		Ref. € U.	5601120 27,70 6	5601125 27,95 5	5601150 29,95 3	5601175 33,75 2	5601200 38,35 2		
Tubo Pipe Conduit 500 mm		Ref. € U.	5602120 20,65 12	5602125 20,75 10	5602150 22,35 6	5602175 24,10 4	5602200 27,40 4		
Tubo con llave Pipe with Tap Conduit clé 1.000 mm		Ref. € U.	5605120 41,45 6	5605125 41,95 5	5605150 46,05 3	5605175 52,40 2	5605200 58,90 2		
Codo Elbow Coude 45°		Ref. € U.	5615120 22,85 10	5615125 23,15 10	5615150 25,90 10	5615175 27,85 10	5615200 32,20 10		
Codo Elbow Coude 90°		Ref. € U.	5616120 28,85 8	5616125 29,05 8	5616150 32,35 8	5616175 37,65 8	5616200 43,65 8		
Te 90° con tapa "T" piece 90° with Cover Té 90° avec tampon		Ref. € U.	5621120 53,10 10	5621125 53,90 6	5621150 58,95 6	5621175 76,80 4	5621200 98,10 4		
Plafón (rosetón) Rosette Rosace		Ref. € U.	5661120 12,80 1	5661125 13,40 1	5661150 15,00 1	5661175 17,85 1	5661200 19,50 1		

7 TP

Tubería Pellet
Pellet Piping
Tubage Pêle à pellets

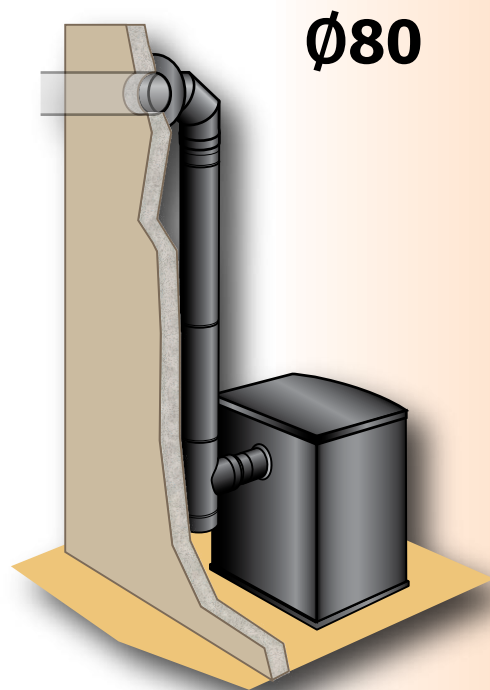

Ø80

SIMPLE PARED VITRIFICADO
VITREOUS ENAMEL SINGLE WALL
SIMPLE PAROI ÉMAILLÉE

Ø80 - 100

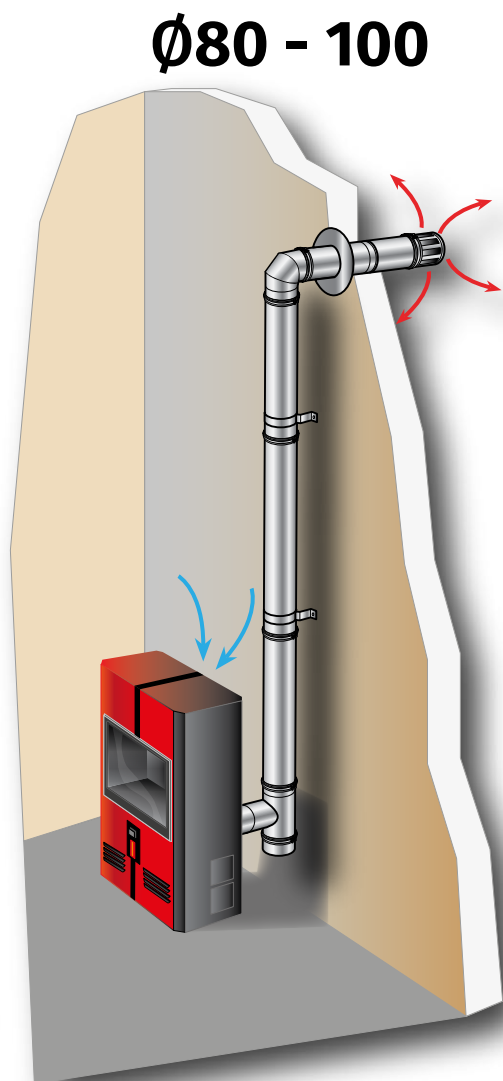

Ø80 - 100

SIMPLE PARED
SINGLE WALL
SIMPLE PAROI

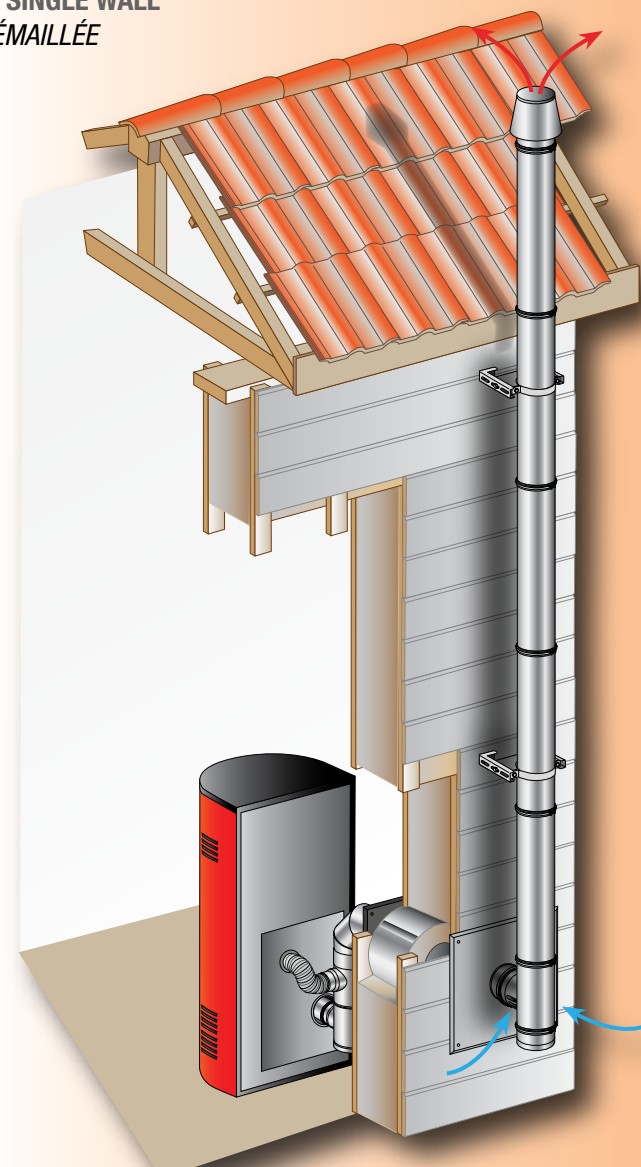

DOBLE PARED
DOUBLE WALL
DOUBLE PAROI

Ø80/130 - Ø100/150

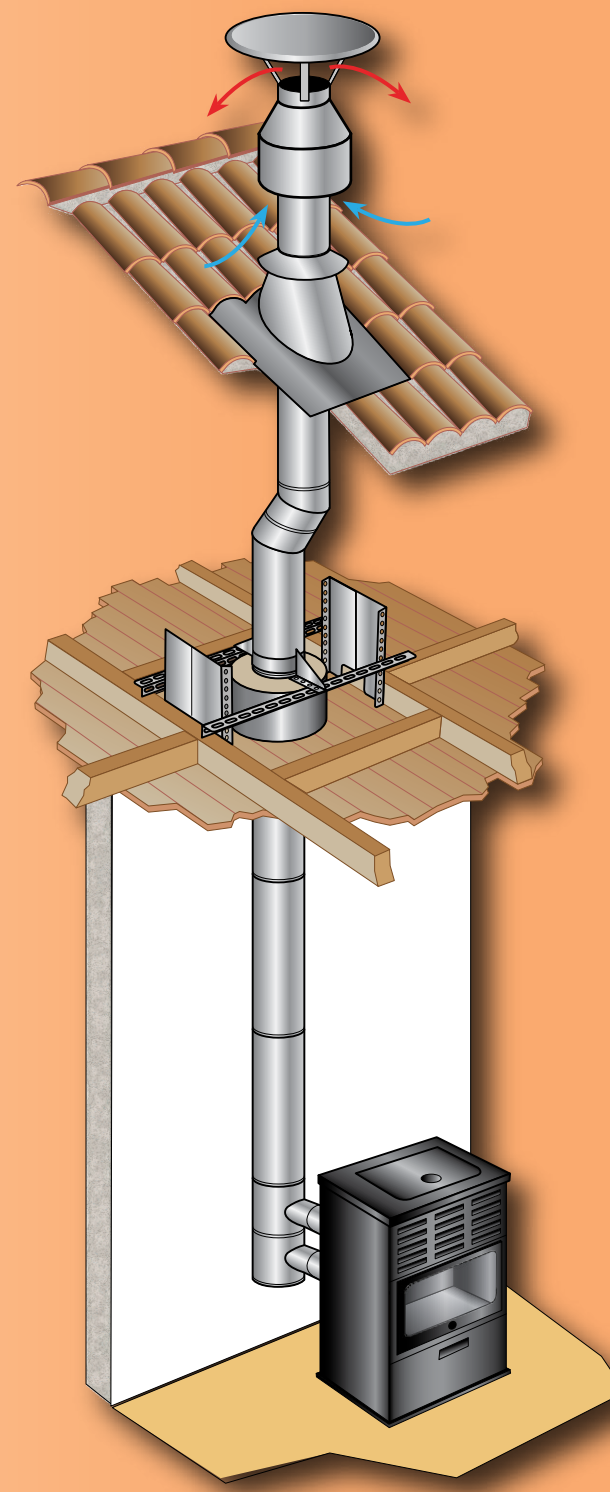

CONDUCTO CONCÉNTRICO
CONCENTRIC PIPING
CONDUIT CONCENRIQUE

CE Especificaciones de acuerdo a la legislación europea en productos de construcción CPR
Specifications according to EU product regulations of construction CPR
Spécifications Selon la réglementation européenne concernant les produits de construction CPR



SIMPLE PARED
SINGLE WALL
SIMPLE PAROI
AISI 316L Ø80 - 100
EN 1856-1
T200 P1 W V2 L50040 O(30)*

SIMPLE PARED "EASY LINE"
SINGLE WALL "EASY LINE"
SIMPLE PAROI "EASY LINE"
VITRI-M Ø80
EN 1856-2
T200 P1 W Vm L80050 O(30) M

Incluye junta | Include gasket | Avec joint d'étanchéité

SIMPLE PARED NEGRO MATE
SINGLE WALL, MATT-BLACK
SIMPLE PAROI NOIR MAT
AISI 316L Ø80 - 100
EN 1856-2
T200 P1 W V2 L50040 O(75)M*

DOBLE PARED
DOUBLE WALL
DOUBLE PAROI
AISI 316L-304 Ø80 - 100
EN 1856-1
T200 P1 W V2 L50040 O(15)*

CONDUCTO CONCÉNTRICO
CONCENTRIC PIPING
CONDUIT CONCENRIQUE
AISI 316L-304 Ø80/130 - 100/150
EN 14989-2
T200 P1 W V2 L50040 O(20)*

* Para cumplir con esta designación todos los elementos deben estar instalados con juntas, consulte la página 26-27. Para saber el número de juntas, consulte la página 165.

* To comply with this designation, all elements must be installed with gaskets, see page 26-27. For the number of joints, see page 165.

* Pour respecter cette désignation, tous les éléments doivent être installés avec des joints, voir page 26-27. Unités de joints par élément, voir page 165.

Para el resto de elementos, la junta es opcional.
For all other elements, the gasket is optional.
Pour tous les autres éléments, le joint est optionnel.



Referencia Reference Référence	Ref.	4009353	Unidad de embalaje Packaging unit Unités par emballage
Precio unidad € Unit price, € Prix unité €	€ U.	29,66 6	

Módulo lineal Linear module Élément droit L1000 mm ØD 80 100 Ref. 4009353 4009354 € U. 29,66 6 34,04 6	Módulo lineal Linear module Élément droit L500 mm ØD 80 100 Ref. 4010842 4011369 € U. 18,43 4 20,70 4	Módulo lineal Linear module Élément droit L250 mm ØD 80 100 Ref. 4009591 4016229 € U. 11,03 4 12,12 4	Módulo extensible Extendable module Élément télescopique Lmin 500 - Lmax 900 ØD 80 100 Ref. 4010852 4022302 € U. 41,30 2 42,90 2	Módulo extensible Extendable module Élément télescopique Lmin 355 - Lmax 565 ØD 80 100 Ref. 4010847 4016643 € U. 31,58 2 34,51 2
Módulo extensible Extendable module Élément télescopique Lmin 200 - Lmax 300 ØD 80 100 Ref. 4010851 4016632 € U. 23,51 2 25,46 2	Codo Elbow Coude 15° ØD 80 100 Ref. 4019654 4019656 € U. 26,81 4 27,41 4	Codo Elbow Coude 30° ØD 80 100 Ref. 4015623 4019645 € U. 17,27 4 19,84 4	Codo Elbow Coude 45° ØD 80 100 Ref. 4010245 4011367 € U. 17,27 4 19,84 4	Codo Elbow Coude 87° ØD 80 100 Ref. 4009838 4010442 € U. 25,42 4 28,19 4
Adaptador Macho-Macho Male-Male Adapter Adaptateur Mâle-Mâle ØD 80 100 Ref. 4010845 4016603 € U. 11,75 4 13,81 4	Adaptador Hembra-Hembra Female-Female Adapter Adaptateur Femelle-Femelle ØD 80 100 Ref. 4009592 4015046 € U. 12,09 4 14,46 4	Te "T" Piece Té 90° ØD 80 100 Ref. 4022035 4022036 € U. 32,04 3 36,70 3	Te "T" Piece Té 93° ØD 80 100 Ref. 4022073 4022074 € U. 32,04 3 36,70 3	Te "T" Piece Té 135° ØD 80 100 Ref. 4022250 4022251 € U. 46,13 2 48,82 2
Te base con tapa Base "T" Piece with cap Té départ avec tampon ØD 80 100 Ref. 4021627 4011365 € U. 54,13 2 59,55 2	Módulo de inspección Inspection module Module d'inspection ØD 80 100 Ref. 4020116 4020117 € U. 45,47 1 51,01 1	Codo de inspección Inspection elbow Coude d'inspection 87° ØD 80 100 Ref. 4024385 4024387 € U. 70,62 1 74,79 1	Tapa de inspección Inspection cover Trappe d'inspection 200°C / 200 Pa ØD 80 100 Ref. 5003265 5003266 € U. 18,75 1 19,01 1	Tapa Cap Tampon ØD 80 100 Ref. 4010844 4015924 € U. 13,43 4 14,31 4
Tapa purga Condensate cap Tampon récupérateur condensats ØD 80 100 Ref. 4015544 4015955 € U. 22,08 4 22,86 4	Tapa purga lateral Lateral condensate cap Tampon récupérateur condensats laterale ØD 80 100 Ref. 4019678 4019680 € U. 31,15 1 32,15 1	Sombrero antilluvia Rain cap Chapeau pare-pluie ØD 80 100 Ref. 4010843 4011368 € U. 40,72 1 43,13 1	Sombrero antiretorno Non-return cap Chapeau anti-refoulement ØD 80 100 Ref. 4011403 4011370 € U. 64,16 1 70,89 1	Sombrero salida libre Outlet cone Cône de finition ØD 80 100 Ref. 4015110 4016454 € U. 34,44 1 38,16 1

Sombrero pico-flauta Flute peak cap Chapeau de flûte ØD 80 100 Ref. 4007540 4007541 € U. 44,46 1 46,74 1	Sombrero salida horizontal Horizontal outlet cap Chapeau sortie horizontale 500 mm ØD 80 100 Ref. 4014937 4016484 € U. 33,87 1 35,18 1	Collarín Storm collar Collerette 75 mm ØD 80 100 Ref. 4019980 4019981 € U. 18,95 1 19,57 1	Rosetón Rosette Rosace ØD 80 100 Ref. 4007378 2700643 € U. 19,04 1 19,57 1	Embellecedor techo horizontal 1 pieza Horizontal sloping roof trim 1 unit Plaque de finition 1 pièce ØD 80 100 Ref. 4014804 4015186 € U. 12,97 1 13,91 1
Junta silicona Silicone gasket Joint silicone ØD 80 100 Ref. 5003948 5003950 € U. 1,00 10 1,09 10	Rosetón EPDM Rosette EPDM Rosace EPDM ØD 80 100 Ref. 5005897 5005899 € U. 4,23 1 5,28 1	Abrazadera mural interior Interior wall bracket Bride murale intérieur ØD 80 100 Ref. 2500046 2500037 € U. 7,48 6 8,55 6	Abrazadera atornillada Screwed bracket Collier à vis ØD 80 100 Ref. 2500026 2500023 € U. 6,21 1 6,43 1	Cubreaguas inoxidable horizontal Horizontal stainless steel roof flashing Solin inoxydable horizontal ØD 80 100 Ref. 2700944 2700939 € U. 62,31 1 68,12 1
Cubreaguas inoxidable Stainless steel roof flashing Solin inoxydable 5°-25° + collarín 75mm + storm collar 75mm + collerette 75mm ØD 80 100 Ref. 4026713 4026715 € U. 131,20 1 134,28 1	Cubreaguas inoxidable Stainless steel roof flashing Solin inoxydable 25°-45° + collarín 75mm + storm collar 75mm + collerette 75mm ØD 80 100 Ref. 4026730 4026731 € U. 134,31 1 137,20 1	Cubreaguas inoxidable Stainless steel roof flashing Solin inoxydable 45°-60° + collarín 75mm + storm collar 75mm + collerette 75mm ØD 80 100 Ref. 4026745 4026746 € U. 147,74 1 151,32 1	Aumento Augmentation adapter Augmentation ØD 80-100 Ref. 4015946 € U. 39,92 1	Reducción Reduction adapter Réduction ØD 80-100 Ref. 4022589 € U. 42,96 1

Kit instalación estufas pellet | Installation kit pellet stoves | Kit installation poêles à granulés

EN 1856-2 T200 P1 W V2 L50040 O (30)



Diámetro / Diameter / Diamètre	80
Espesor / Sheet thickness / Épaisseur paroi	0,4
Referencia / Reference / Référence	5007180
Precio / Price / Prix €	192,45

- Consta de / Contains : / Composé de :
- 1 Tubo de 1000 mm *
 - 1 Tubo de 500 mm *
 - 1 Codo 87° *
 - 1 Te base 90° con tapa *
 - 1 Rosetón
 - * Juntas de silicona incluidas
- 1 Pipe 1000 mm *
 - 1 Pipe 500 mm *
 - 1 Elbow 87° *
 - 1 Base "T" piece 90° with Cover *
 - 1 Rosette
 - * Silicone Gaskets are included
- 1 Conduit 1.000 mm *
 - 1 Conduit 500 mm *
 - 1 Coude 87° *
 - 1 Té départ 90° avec tampon *
 - 1 Rosace
 - * Joints en silicone sont inclus

TP

Simple Pared "Easy Line" | Single Wall, "Easy Line" | Simple Paroi, "Easy Line"

Ø 80

fabricado en: vitrificado | made of: vitrified | fabriquée en: vitrifié

Ø 80 mm Simple Pared de 0,8 mm de espesor total vitrificado negro mate a 900°C
 Ø 80 mm Single Wall with 0,8 mm total thickness matt-black vitrified at 900°C
 Ø 80 mm Simple Paroi avec 0,8 mm d'épaisseur total vitrifié noir mat à 900°C

Referencia Reference Référence	Ref.	5701080	Unidad de embalaje Packaging unit Unités par emballage
Precio unidad € Unit price, € Prix unité €	€ U.	23,55 6	

Incluye juntas Gaskets included Joints inclus	Juntas necesarias Required gaskets Joints nécessaires
	xn

EN 1856-2 T200 P1 W Vm L80050 O(30) M

Tubo Pipe Conduit x1 1000 mm ØD 80 Ref. 5701080 € U. 23,55 6	Tubo Pipe Conduit x1 500 mm ØD 80 Ref. 5702080 € U. 20,85 12	Tubo Pipe Conduit x1 250 mm ØD 80 Ref. 5703080 € U. 17,95 4	Codo Elbow Coude x1 45° ØD 80 Ref. 5715080 € U. 28,60 4	Codo Elbow Coude x1 87° ØD 80 Ref. 5716080 € U. 30,85 4
Te base con tapa Base "T" Piece with cover Té départ avec tampon x2 90° ØD 80 Ref. 5721080 € U. 49,70 2	Manguito Connection hose Manchette de raccordement x1 143 mm ØD 80 Ref. 5753080 € U. 21,10 6	Plafón Rosette Rosace ØD 80 Ref. 5361080 € U. 11,45 1	Deflector (316L) Deflector (316L) Déflecteur (316L) x1 ØD 80 Ref. 5734080 € U. 31,15 1	Sombrero antiretorno "cerco" (316L) "Cerco" antireturn cap (316L) Chapeau anti-refoulement (316L) ØD 80 Ref. 4022889 € U. 46,30 1

Abrazadera mural interior (304) Interior wall band (304) Bride murale intérieur (304) ØD 80 Ref. 4014719 € U. 11,38 1	Abrazadera atornillada (304) Screwed bracket (304) Collier à vis (304) ØD 80 Ref. 4028727 € U. 10,78 1
---	--

Kit instalación estufas pellet Installation kit pellet stoves Kit installation poêles à granulés



EN 1856-2 T200 P1 W Vm L80050 O (30) M

Diámetro / Diameter / Diamètre	80
Espesor total / Total thickness / Épaisseur total	0,8
Referencia / Reference / Référence	5007080
Precio / Price / Prix €	152,70

- Consta de / Contains: / Composé de:
- 1 Tubo de 1000 mm *
 - 1 Tubo de 500 mm *
 - 1 Codo 87° *
 - 1 Te base 90° con tapa *
 - 1 Rosetón
 - * Juntas de silicona incluidas
- 1 Pipe 1000 mm *
- 1 Pipe 500 mm *
- 1 Elbow 87° *
- 1 Base "T" piece 90° with Cover *
- 1 Rosette
- * Silicone Gaskets are included
- 1 Conduit 1.000 mm *
 - 1 Conduit 500 mm *
 - 1 Coude 87° *
 - 1 Té 90° avec tampon *
 - 1 Rosace
 - * Joints en silicone sont inclus

Recambios | Spares | Pièces de rechange

Junta silicona Silicone gasket Joint silicone 200°C ØD 80 Ref. 5003948 € U. 1,00 10	Junta silicona "hijuela T" Silicone gasket "branch T" piece Joint silicone "annexe Té" 200°C ØD 80 Ref. 5003406 € U. 0,80 1
---	---

TP

Simple pared negro mate | Single wall matt-black | Simple paroi noir mat

Ø 80-100

fabricado en: | made of: | fabriquée en: | AISI 316L

600° senotherm®

Referencia Reference Référence	Ref.	4022857	Unidad de embalaje Packaging unit Unités par emballage
Precio unidad € Unit price, € Prix unité €	€ U.	41,30 1	

Módulo lineal Linear module Élément droit 1000 mm ØD 80 100 Ref. 4022857 4022858 € U. 41,30 1 47,20 1	Módulo lineal Linear module Élément droit 500 mm ØD 80 100 Ref. 4022860 4022861 € U. 25,96 1 29,50 1	Módulo lineal Linear module Élément droit 250 mm ØD 80 100 Ref. 4022863 4022864 € U. 17,11 1 19,47 1	Módulo extensible Extendable module Élément télescopique L=335-565 ØD 80 100 Ref. 4022866 4022867 € U. 46,04 1 52,70 1	Codo Elbow Coude 45° ØD 80 100 Ref. 4022882 4022883 € U. 28,06 1 31,55 1
Codo Elbow Coude 87° ØD 80 100 Ref. 4022886 4022887 € U. 36,82 1 41,30 1	Adaptador caldera estanco Boiler adapter Adaptateur chaudière x1 ØD 80 100 Ref. 4015206 4016125 € U. 28,50 1 30,97 1	Manguito de unión Connection hose Manchette de raccordement x1 ØD 80 100 Ref. 4016130 4016131 € U. 28,75 1 31,23 1	Adaptador hembra-hembra Double female adapter Adaptateur femelle-femelle ØD 80 100 Ref. 4022901 4022902 € U. 25,24 1 29,36 1	Analizador gas Gas analyzer Analyseur de gaz ØD 80 100 Ref. 4027395 4027396 € U. 43,70 1 46,00 1
Te "T" Piece Té 90° ØD 80 100 Ref. 4022869 4022870 € U. 42,75 1 49,50 1	Te base con tapa Base "T" Piece with cover Té départ avec tampon x2 90° ØD 80 100 Ref. 4024167 4016689 € U. 71,98 1 79,06 1	Tapa Cover Tampon Tapa Cover Tampon Tapa purga Purge cover Tampon récupérateur condensats ØD 80 100 Ref. A 4022875 4022878 € U. 19,45 1 22,48 1 Ref. B 4022872 4022873 € U. 29,45 1 31,78 1	Embellecedor 1 pieza Trim, 1 piece Toit horizontal 1 pièce ØD 80 100 Ref. 4015203 4016147 € U. 27,46 1 31,73 1	Embellecedor 2 piezas Sloping roof trim 2 units Toit horizontal 2 pièces ØD 80 100 Ref. 4023250 4023394 € U. 32,20 1 35,70 1
Rosetón Rosette Rosace 200 mm ØD 80 100 Ref. 4016074 4016077 € U. 28,32 1 30,21 1	Collarín Storm Collar Collerette 75 mm ØD 80 100 Ref. 4014679 4016124 € U. 32,28 1 36,40 1	Abrazadera mural interior Interior wall band Bride murale intérieur ØD 80 100 Ref. 4014719 4016109 € U. 11,38 1 13,05 1	Abrazadera atornillada Screwed bracket Collier à vis ØD 80 100 Ref. 4028727 4028728 € U. 10,78 1 11,09 1	Cubreaguas plomo Lead roof flashing Solin plomb 5°-25° ØD 80 100 Ref. 4014680 4016122 € U. 172,42 1 185,25 1
Cubreaguas plomo Lead roof flashing Solin plomb 25°-45° ØD 80 100 Ref. 4024245 4016123 € U. 177,37 1 190,95 1	Sombrero antiretorno "Cerco" "Cerco" antireturn cap Chapeau anti-refoulement "Cerco" 25°-45° ØD 80 100 Ref. 4022889 4022890 € U. 78,41 1 87,43 1	Sombrero antilluvia "Seta" "Seta" rain cap Chapeau pare-pluie "Seta" ØD 80 100 Ref. 4022893 4022894 € U. 53,89 1 58,60 1	Aumento excéntrico Condensate cap Coude ØD 80-100 Ref. 4022920 € U. 51,92 1	Junta silicona Silicone gasket Joint silicone ØD 80 100 Ref. 5003948 5003950 € U. 1,00 10 1,09 10

Referencia Reference Référence	Ref.	4015086	Unidad de embalaje Packaging unit Unités par emballage
Precio unidad € Unit price, € Prix unité €	€ U.	73,46 1	

<p>Módulo lineal Linear module Élément droit</p> <p>L1000</p> <table border="1"> <tr><td>ØDi</td><td>80</td><td>100</td></tr> <tr><td>Ref.</td><td>4015086</td><td>4015569</td></tr> <tr><td>€ U.</td><td>73,46 1</td><td>80,75 1</td></tr> </table>	ØDi	80	100	Ref.	4015086	4015569	€ U.	73,46 1	80,75 1	<p>Módulo lineal Linear module Élément droit</p> <p>L500</p> <table border="1"> <tr><td>ØDi</td><td>80</td><td>100</td></tr> <tr><td>Ref.</td><td>4013603</td><td>4016254</td></tr> <tr><td>€ U.</td><td>41,51 1</td><td>49,22 1</td></tr> </table>	ØDi	80	100	Ref.	4013603	4016254	€ U.	41,51 1	49,22 1	<p>Módulo lineal Linear module Élément droit</p> <p>L250</p> <table border="1"> <tr><td>ØDi</td><td>80</td><td>100</td></tr> <tr><td>Ref.</td><td>4013602</td><td>4016260</td></tr> <tr><td>€ U.</td><td>31,66 1</td><td>34,76 1</td></tr> </table>	ØDi	80	100	Ref.	4013602	4016260	€ U.	31,66 1	34,76 1	<p>Módulo extensible Extendable module Élément télescopique</p> <p>Lmin 500 - Lmax 900</p> <table border="1"> <tr><td>ØDi</td><td>80</td><td>100</td></tr> <tr><td>Ref.</td><td>4013605</td><td>4016667</td></tr> <tr><td>€ U.</td><td>118,64 1</td><td>128,65 1</td></tr> </table>	ØDi	80	100	Ref.	4013605	4016667	€ U.	118,64 1	128,65 1	<p>Módulo extensible Extendable module Élément télescopique</p> <p>Lmin 355 - Lmax 565</p> <table border="1"> <tr><td>ØDi</td><td>80</td><td>100</td></tr> <tr><td>Ref.</td><td>4012226</td><td>4016664</td></tr> <tr><td>€ U.</td><td>81,65 1</td><td>87,76 1</td></tr> </table>	ØDi	80	100	Ref.	4012226	4016664	€ U.	81,65 1	87,76 1
ØDi	80	100																																															
Ref.	4015086	4015569																																															
€ U.	73,46 1	80,75 1																																															
ØDi	80	100																																															
Ref.	4013603	4016254																																															
€ U.	41,51 1	49,22 1																																															
ØDi	80	100																																															
Ref.	4013602	4016260																																															
€ U.	31,66 1	34,76 1																																															
ØDi	80	100																																															
Ref.	4013605	4016667																																															
€ U.	118,64 1	128,65 1																																															
ØDi	80	100																																															
Ref.	4012226	4016664																																															
€ U.	81,65 1	87,76 1																																															
<p>Módulo extensible Extendable module Élément télescopique</p> <p>Lmin 200 - Lmax 300</p> <table border="1"> <tr><td>ØDi</td><td>80</td><td>100</td></tr> <tr><td>Ref.</td><td>4013604</td><td>4016659</td></tr> <tr><td>€ U.</td><td>55,16 1</td><td>64,06 1</td></tr> </table>	ØDi	80	100	Ref.	4013604	4016659	€ U.	55,16 1	64,06 1	<p>Codo Elbow Coude</p> <p>15°</p> <table border="1"> <tr><td>ØDi</td><td>80</td><td>100</td></tr> <tr><td>Ref.</td><td>4016570</td><td>4016571</td></tr> <tr><td>€ U.</td><td>45,22 1</td><td>47,83 1</td></tr> </table>	ØDi	80	100	Ref.	4016570	4016571	€ U.	45,22 1	47,83 1	<p>Codo Elbow Coude</p> <p>30°</p> <table border="1"> <tr><td>ØDi</td><td>80</td><td>100</td></tr> <tr><td>Ref.</td><td>4015622</td><td>4016580</td></tr> <tr><td>€ U.</td><td>49,18 1</td><td>52,02 1</td></tr> </table>	ØDi	80	100	Ref.	4015622	4016580	€ U.	49,18 1	52,02 1	<p>Codo Elbow Coude</p> <p>45°</p> <table border="1"> <tr><td>ØDi</td><td>80</td><td>100</td></tr> <tr><td>Ref.</td><td>4015063</td><td>4016586</td></tr> <tr><td>€ U.</td><td>52,65 1</td><td>54,66 1</td></tr> </table>	ØDi	80	100	Ref.	4015063	4016586	€ U.	52,65 1	54,66 1	<p>Codo Elbow Coude</p> <p>87°</p> <table border="1"> <tr><td>ØDi</td><td>80</td><td>100</td></tr> <tr><td>Ref.</td><td>4019668</td><td>4019669</td></tr> <tr><td>€ U.</td><td>90,11 1</td><td>95,44 1</td></tr> </table>	ØDi	80	100	Ref.	4019668	4019669	€ U.	90,11 1	95,44 1
ØDi	80	100																																															
Ref.	4013604	4016659																																															
€ U.	55,16 1	64,06 1																																															
ØDi	80	100																																															
Ref.	4016570	4016571																																															
€ U.	45,22 1	47,83 1																																															
ØDi	80	100																																															
Ref.	4015622	4016580																																															
€ U.	49,18 1	52,02 1																																															
ØDi	80	100																																															
Ref.	4015063	4016586																																															
€ U.	52,65 1	54,66 1																																															
ØDi	80	100																																															
Ref.	4019668	4019669																																															
€ U.	90,11 1	95,44 1																																															
<p>Adaptador DP-SP DW-SW adapter Adaptateur DP-SP</p> <table border="1"> <tr><td>ØDi</td><td>80</td><td>100</td></tr> <tr><td>Ref.</td><td>4015108</td><td>4016622</td></tr> <tr><td>€ U.</td><td>34,66 1</td><td>35,46 1</td></tr> </table>	ØDi	80	100	Ref.	4015108	4016622	€ U.	34,66 1	35,46 1	<p>Te "T" Piece Té</p> <p>90°</p> <table border="1"> <tr><td>ØDi</td><td>80</td><td>100</td></tr> <tr><td>Ref.</td><td>4019993</td><td>4019994</td></tr> <tr><td>€ U.</td><td>80,16 1</td><td>90,02 1</td></tr> </table>	ØDi	80	100	Ref.	4019993	4019994	€ U.	80,16 1	90,02 1	<p>Te "T" Piece Té</p> <p>135°</p> <table border="1"> <tr><td>ØDi</td><td>80</td><td>100</td></tr> <tr><td>Ref.</td><td>4021783</td><td>4021786</td></tr> <tr><td>€ U.</td><td>126,14 1</td><td>162,80 1</td></tr> </table>	ØDi	80	100	Ref.	4021783	4021786	€ U.	126,14 1	162,80 1	<p>Te base con tapa "T" Piece with cover Te base avec tampon</p> <table border="1"> <tr><td>ØDi</td><td>80</td><td>100</td></tr> <tr><td>Ref.</td><td>4031146</td><td>4031147</td></tr> <tr><td>€ U.</td><td>98,82 1</td><td>110,98 1</td></tr> </table>	ØDi	80	100	Ref.	4031146	4031147	€ U.	98,82 1	110,98 1	<p>Te con admisión aire "T" Piece with admission Té avec admission d'air</p> <table border="1"> <tr><td>ØDi</td><td>80-80/125</td><td>100-100/150</td></tr> <tr><td>Ref.</td><td>4022136</td><td>4022137</td></tr> <tr><td>€ U.</td><td>100,21 1</td><td>112,62 1</td></tr> </table>	ØDi	80-80/125	100-100/150	Ref.	4022136	4022137	€ U.	100,21 1	112,62 1
ØDi	80	100																																															
Ref.	4015108	4016622																																															
€ U.	34,66 1	35,46 1																																															
ØDi	80	100																																															
Ref.	4019993	4019994																																															
€ U.	80,16 1	90,02 1																																															
ØDi	80	100																																															
Ref.	4021783	4021786																																															
€ U.	126,14 1	162,80 1																																															
ØDi	80	100																																															
Ref.	4031146	4031147																																															
€ U.	98,82 1	110,98 1																																															
ØDi	80-80/125	100-100/150																																															
Ref.	4022136	4022137																																															
€ U.	100,21 1	112,62 1																																															
<p>Adaptador biflujo Biflow adapter Adaptateur bifluje</p> <table border="1"> <tr><td>ØDi</td><td>80/125</td><td>100/150</td></tr> <tr><td>Ref.</td><td>4040020</td><td>4040022</td></tr> <tr><td>€ U.</td><td>103,68 1</td><td>121,54 1</td></tr> </table>	ØDi	80/125	100/150	Ref.	4040020	4040022	€ U.	103,68 1	121,54 1	<p>Codo inspección Inspection cover Trappe d'inspection</p> <p>87°</p> <table border="1"> <tr><td>ØDi</td><td>80</td><td>100</td></tr> <tr><td>Ref.</td><td>4019914</td><td>4019915</td></tr> <tr><td>€ U.</td><td>156,65 1</td><td>160,78 1</td></tr> </table>	ØDi	80	100	Ref.	4019914	4019915	€ U.	156,65 1	160,78 1	<p>Módulo de inspección Inspection module Module d'inspection</p> <table border="1"> <tr><td>ØDi</td><td>80</td><td>100</td></tr> <tr><td>Ref.</td><td>4020059</td><td>4020060</td></tr> <tr><td>€ U.</td><td>104,10 1</td><td>110,55 1</td></tr> </table>	ØDi	80	100	Ref.	4020059	4020060	€ U.	104,10 1	110,55 1	<p>Tapa de inspección Inspection cover Trappe d'inspection</p> <p>200°C / 200 Pa</p> <table border="1"> <tr><td>ØDi</td><td>80</td><td>100</td></tr> <tr><td>Ref.</td><td>5003265</td><td>5003266</td></tr> <tr><td>€ U.</td><td>18,75 1</td><td>19,01 1</td></tr> </table>	ØDi	80	100	Ref.	5003265	5003266	€ U.	18,75 1	19,01 1	<p>Tapa Cap Tampon</p> <table border="1"> <tr><td>ØDi</td><td>80</td><td>100</td></tr> <tr><td>Ref.</td><td>4015925</td><td>4015931</td></tr> <tr><td>€ U.</td><td>22,11 1</td><td>23,26 1</td></tr> </table>	ØDi	80	100	Ref.	4015925	4015931	€ U.	22,11 1	23,26 1
ØDi	80/125	100/150																																															
Ref.	4040020	4040022																																															
€ U.	103,68 1	121,54 1																																															
ØDi	80	100																																															
Ref.	4019914	4019915																																															
€ U.	156,65 1	160,78 1																																															
ØDi	80	100																																															
Ref.	4020059	4020060																																															
€ U.	104,10 1	110,55 1																																															
ØDi	80	100																																															
Ref.	5003265	5003266																																															
€ U.	18,75 1	19,01 1																																															
ØDi	80	100																																															
Ref.	4015925	4015931																																															
€ U.	22,11 1	23,26 1																																															
<p>Tapa purga Condensate cap Tampon récupérateur condensats</p> <table border="1"> <tr><td>ØDi</td><td>80</td><td>100</td></tr> <tr><td>Ref.</td><td>4015936</td><td>4015575</td></tr> <tr><td>€ U.</td><td>28,10 1</td><td>29,26 1</td></tr> </table>	ØDi	80	100	Ref.	4015936	4015575	€ U.	28,10 1	29,26 1	<p>Soporte mural intermedio Intermediate wall support Support mural base</p> <table border="1"> <tr><td>ØDi</td><td>80</td><td>100</td></tr> <tr><td>Ref.</td><td>4020107</td><td>4020108</td></tr> <tr><td>€ U.</td><td>53,77 1</td><td>57,87 1</td></tr> </table>	ØDi	80	100	Ref.	4020107	4020108	€ U.	53,77 1	57,87 1	<p>Sombrero antiretorno Non-return cap Chapeau anti-refoulement</p> <table border="1"> <tr><td>ØDi</td><td>80</td><td>100</td></tr> <tr><td>Ref.</td><td>4015062</td><td>4015573</td></tr> <tr><td>€ U.</td><td>68,25 1</td><td>83,07 1</td></tr> </table>	ØDi	80	100	Ref.	4015062	4015573	€ U.	68,25 1	83,07 1	<p>Sombrero antilluvia Rain cap Chapeau pare-pluie</p> <table border="1"> <tr><td>ØDi</td><td>80</td><td>100</td></tr> <tr><td>Ref.</td><td>4013784</td><td>4016434</td></tr> <tr><td>€ U.</td><td>41,97 1</td><td>46,77 1</td></tr> </table>	ØDi	80	100	Ref.	4013784	4016434	€ U.	41,97 1	46,77 1	<p>Sombrero salida libre Exhaust high cone Cône de finition haute</p> <table border="1"> <tr><td>ØDi</td><td>80</td><td>100</td></tr> <tr><td>Ref.</td><td>4016458</td><td>4016459</td></tr> <tr><td>€ U.</td><td>43,65 1</td><td>45,13 1</td></tr> </table>	ØDi	80	100	Ref.	4016458	4016459	€ U.	43,65 1	45,13 1
ØDi	80	100																																															
Ref.	4015936	4015575																																															
€ U.	28,10 1	29,26 1																																															
ØDi	80	100																																															
Ref.	4020107	4020108																																															
€ U.	53,77 1	57,87 1																																															
ØDi	80	100																																															
Ref.	4015062	4015573																																															
€ U.	68,25 1	83,07 1																																															
ØDi	80	100																																															
Ref.	4013784	4016434																																															
€ U.	41,97 1	46,77 1																																															
ØDi	80	100																																															
Ref.	4016458	4016459																																															
€ U.	43,65 1	45,13 1																																															

<p>Sombrero terminal sencillo Simple cap Cône de finition</p> <table border="1"> <tr><td>ØD</td><td>80</td><td>100</td></tr> <tr><td>Ref.</td><td>4016487</td><td>4016488</td></tr> <tr><td>€ U.</td><td>22,69 1</td><td>25,08 1</td></tr> </table>	ØD	80	100	Ref.	4016487	4016488	€ U.	22,69 1	25,08 1	<p>Sombrero pico flauta Flute peak cap Chapeau de flûte</p> <table border="1"> <tr><td>ØD</td><td>80</td><td>100</td></tr> <tr><td>Ref.</td><td>4014044</td><td>4009839</td></tr> <tr><td>€ U.</td><td>58,25 1</td><td>65,17 1</td></tr> </table>	ØD	80	100	Ref.	4014044	4009839	€ U.	58,25 1	65,17 1	<p>Sombrero salida vertical Vertical outlet cap Chapeau sortie verticale</p> <table border="1"> <tr><td>ØD</td><td>80</td><td>100</td></tr> <tr><td>Ref.</td><td>4014655</td><td>4014656</td></tr> <tr><td>€ U.</td><td>106,82 1</td><td>118,58 1</td></tr> </table>	ØD	80	100	Ref.	4014655	4014656	€ U.	106,82 1	118,58 1	<p>Junta silicona Silicone gasket Joint silicone</p> <table border="1"> <tr><td>ØD</td><td>80</td><td>100</td></tr> <tr><td>Ref.</td><td>5003948</td><td>5003950</td></tr> <tr><td>€ U.</td><td>1,00 10</td><td>1,09 10</td></tr> </table>	ØD	80	100	Ref.	5003948	5003950	€ U.	1,00 10	1,09 10
ØD	80	100																																					
Ref.	4016487	4016488																																					
€ U.	22,69 1	25,08 1																																					
ØD	80	100																																					
Ref.	4014044	4009839																																					
€ U.	58,25 1	65,17 1																																					
ØD	80	100																																					
Ref.	4014655	4014656																																					
€ U.	106,82 1	118,58 1																																					
ØD	80	100																																					
Ref.	5003948	5003950																																					
€ U.	1,00 10	1,09 10																																					
<p>Abrazadera atornillada Screwed bracket Collier à vis</p> <table border="1"> <tr><td>ØD</td><td>80</td><td>100</td></tr> <tr><td>Ref.</td><td>2500024</td><td>2500025</td></tr> <tr><td>€ U.</td><td>6,88 1</td><td>7,07 1</td></tr> </table>	ØD	80	100	Ref.	2500024	2500025	€ U.	6,88 1	7,07 1	<p>Abrazadera forjado reforzada Interior wall bracket Bride murale intérieure</p> <table border="1"> <tr><td>ØD</td><td>80</td><td>100</td></tr> <tr><td>Ref.</td><td>4026828</td><td>9023220</td></tr> <tr><td>€ U.</td><td>33,87 1</td><td>34,05 1</td></tr> </table>	ØD	80	100	Ref.	4026828	9023220	€ U.	33,87 1	34,05 1	<p>Abrazadera mural interior Interior wall bracket Bride murale intérieure</p> <table border="1"> <tr><td>ØD</td><td>80</td><td>100</td></tr> <tr><td>Ref.</td><td>2500038</td><td>2500039</td></tr> <tr><td>€ U.</td><td>10,06 6</td><td>10,68 6</td></tr> </table>	ØD	80	100	Ref.	2500038	2500039	€ U.	10,06 6	10,68 6	<p>Abrazadera pared regulable Adjustable wall bracket Collier mural réglable</p> <table border="1"> <tr><td>ØD</td><td>80</td><td>100</td></tr> <tr><td>Ref.</td><td>4600707</td><td>4600703</td></tr> <tr><td>€ U.</td><td>12,12 1</td><td>14,04 1</td></tr> </table>	ØD	80	100	Ref.	4600707	4600703	€ U.	12,12 1	14,04 1
ØD	80	100																																					
Ref.	2500024	2500025																																					
€ U.	6,88 1	7,07 1																																					
ØD	80	100																																					
Ref.	4026828	9023220																																					
€ U.	33,87 1	34,05 1																																					
ØD	80	100																																					
Ref.	2500038	2500039																																					
€ U.	10,06 6	10,68 6																																					
ØD	80	100																																					
Ref.	4600707	4600703																																					
€ U.	12,12 1	14,04 1																																					
<p>Soporte pared regulable Adjustable wall support Support mural réglable</p> <table border="1"> <tr><td>ØD</td><td>80</td><td>100</td></tr> <tr><td>Ref.</td><td>4600725</td><td>4600721</td></tr> <tr><td>€ U.</td><td>69,83 1</td><td>74,86 1</td></tr> </table>	ØD	80	100	Ref.	4600725	4600721	€ U.	69,83 1	74,86 1	<p>Rosetón Rosette Rosace</p> <table border="1"> <tr><td>ØD</td><td>80</td><td>100</td></tr> <tr><td>Ref.</td><td>2700632</td><td>2700633</td></tr> <tr><td>€ U.</td><td>21,63 1</td><td>23,69 1</td></tr> </table>	ØD	80	100	Ref.	2700632	2700633	€ U.	21,63 1	23,69 1	<p>Embellecedor techo horizontal 1 pieza Horizontal sloping roof trim 1 unit Plaque de finition 1 pièce</p> <table border="1"> <tr><td>ØD</td><td>80</td><td>100</td></tr> <tr><td>Ref.</td><td>4014805</td><td>4014806</td></tr> <tr><td>€ U.</td><td>20,74 1</td><td>23,76 1</td></tr> </table>	ØD	80	100	Ref.	4014805	4014806	€ U.	20,74 1	23,76 1	<p>Collarin Storm collar Collerette</p> <p>75mm</p> <table border="1"> <tr><td>ØD</td><td>80</td><td>100</td></tr> <tr><td>Ref.</td><td>4019983</td><td>4014984</td></tr> <tr><td>€ U.</td><td>23,51 1</td><td>27,07 1</td></tr> </table>	ØD	80	100	Ref.	4019983	4014984	€ U.	23,51 1	27,07 1
ØD	80	100																																					
Ref.	4600725	4600721																																					
€ U.	69,83 1	74,86 1																																					
ØD	80	100																																					
Ref.	2700632	2700633																																					
€ U.	21,63 1	23,69 1																																					
ØD	80	100																																					
Ref.	4014805	4014806																																					
€ U.	20,74 1	23,76 1																																					
ØD	80	100																																					
Ref.	4019983	4014984																																					
€ U.	23,51 1	27,07 1																																					
<p>Cubreaguas inoxidable horizontal Horizontal stainless steel roof flashing Solin inoxydable horizontal</p> <table border="1"> <tr><td>ØDi</td><td>80</td><td>100</td></tr> <tr><td>Ref.</td><td>2700940</td><td>2700868</td></tr> <tr><td>€ U.</td><td>70,15 1</td><td>75,85 1</td></tr> </table>	ØDi	80	100	Ref.	2700940	2700868	€ U.	70,15 1	75,85 1	<p>Cubreaguas inoxidable Stainless steel roof flashing Solin inoxydable</p> <p>5°-25°</p> <table border="1"> <tr><td>ØDi</td><td>80</td><td>100</td></tr> <tr><td>Ref.</td><td>4026718</td><td>4026720</td></tr> <tr><td>€ U.</td><td>137,86 1</td><td>140,73 1</td></tr> </table>	ØDi	80	100	Ref.	4026718	4026720	€ U.	137,86 1	140,73 1	<p>Cubreaguas inoxidable Stainless steel roof flashing Solin inoxydable</p> <p>25°-45°</p> <table border="1"> <tr><td>ØD</td><td>80</td><td>100</td></tr> <tr><td>Ref.</td><td>4026734</td><td>4026736</td></tr> <tr><td>€ U.</td><td>141,40 1</td><td>143,98 1</td></tr> </table>	ØD	80	100	Ref.	4026734	4026736	€ U.	141,40 1	143,98 1	<p>Cubreaguas inoxidable Stainless steel roof flashing Solin inoxydable</p> <p>45°-60°</p> <table border="1"> <tr><td>ØD</td><td>80</td><td>100</td></tr> <tr><td>Ref.</td><td>4026751</td><td>4026753</td></tr> <tr><td>€ U.</td><td>154,53 1</td><td>159,58 1</td></tr> </table>	ØD	80	100	Ref.	4026751	4026753	€ U.	154,53 1	159,58 1
ØDi	80	100																																					
Ref.	2700940	2700868																																					
€ U.	70,15 1	75,85 1																																					
ØDi	80	100																																					
Ref.	4026718	4026720																																					
€ U.	137,86 1	140,73 1																																					
ØD	80	100																																					
Ref.	4026734	4026736																																					
€ U.	141,40 1	143,98 1																																					
ØD	80	100																																					
Ref.	4026751	4026753																																					
€ U.	154,53 1	159,58 1																																					
<p>Aumento Augmentation adapter Augmentation</p> <table border="1"> <tr><td>ØD</td><td>80-100</td></tr> <tr><td>Ref.</td><td>4022715</td></tr> <tr><td>€ U.</td><td>126,27 1</td></tr> </table>	ØD	80-100	Ref.	4022715	€ U.	126,27 1	<p>Reducción Reduction adapter Réduction</p> <table border="1"> <tr><td>ØD</td><td>80-100</td></tr> <tr><td>Ref.</td><td>4022652</td></tr> <tr><td>€ U.</td><td>124,13 1</td></tr> </table>	ØD	80-100	Ref.	4022652	€ U.	124,13 1																										
ØD	80-100																																						
Ref.	4022715																																						
€ U.	126,27 1																																						
ØD	80-100																																						
Ref.	4022652																																						
€ U.	124,13 1																																						

Referencia Reference Référence	Ref.	4025846	Unidad de embalaje Packaging unit Unités par emballage
Precio unidad € Unit price, € Prix unité €	€ U.	87,63 1	

Incluye juntas Gaskets included Joints inclus	Juntas necesarias Required gaskets Joints nécessaires
---	---

Módulo lineal
Linear module
Élément droit

L1000 mm

ØD	80/125	100/150
Ref.	4025846	4014581
€ U.	87,63 1	97,38 1

Módulo lineal
Linear module
Élément droit

L500 mm

ØD	80/125	100/150
Ref.	4022845	4014593
€ U.	72,71 1	80,34 1

Módulo lineal
Linear module
Élément droit

L250 mm

ØD	80/125	100/150
Ref.	4025844	4016739
€ U.	55,52 1	61,80 1

Módulo extensible
Extendable module
Élément télescopique

Lmin 500 - Lmax 900

ØD	80/125	100/150
Ref.	4025850	9023076
€ U.	118,61 1	128,89 1

Sombrero salida vertical
Vertical exit cap
Chapeau sortie verticale

x1

ØD	80/125	100/150
Ref.	4028314	4014585
€ U.	126,10 1	131,70 1

Sombrero salida horizontal
Vertical outlet cap
Chapeau sortie verticale

x1

ØD	80/125	100/150
Ref.	4028315	4016747
€ U.	138,59 1	144,74 1

Junta silicona
Silicone gasket
Joint silicone

ØD	80/125	100/150
Ref.	5003948	5003950
€ U.	1,00 10	1,09 10

Collarín
Storm collar
Collerette

75mm

ØD	80/125	100/150
Ref.	4021061	4019984
€ U.	22,85 1	27,07 1

Módulo extensible
Extendable module
Élément télescopique

Lmin 335 - Lmax 565

ØD	80/125	100/150
Ref.	4025849	4014592
€ U.	105,91 1	115,08 1

Codo
Elbow
Coude

45°

ØD	80/125	100/150
Ref.	4027144	4014583
€ U.	58,02 1	66,36 1

Codo
Elbow
Coude

87°

ØD	80/125	100/150
Ref.	4025847	4014584
€ U.	88,54 1	106,09 1

Te
"T" Piece
Té

93°

ØD	80/125	100/150
Ref.	4028307	4028447
€ U.	78,93 1	84,21 1

Rosetón
Rosette
Rosace

ØD	80/125	100/150
Ref.	4013910	2700633
€ U.	21,18 1	23,69 1

Embellecedor techo horizontal 1 pieza
Horizontal sloping roof trim 1 unit
Plaque de finition 1 pièce

ØD	80/125	100/150
Ref.	4022448	4014806
€ U.	19,06 1	23,76 1

Aumento
Augmentation adapter
Augmentation

x1

ØD	100/150 - 80/125
Ref.	4027828
€ U.	42,96 1

Reducción
Reduction adapter
Réduction

x1

ØD	80/125 - 100/150
Ref.	4019103
€ U.	42,96 1

Te reducida con admisión aire
"T" Piece reduced with admission
Té réduit avec admission d'air

Ø60

90°

ØD	80/125	100/150
Ref.	4028308	4020569
€ U.	94,26 1	111,24 1

Te salida gas con tapa purga
"T" piece gas outlet with condensate cap
Té sortie gaz avec tampon récupérateur condensats

x2

93°

ØD	80/125	100/150
Ref.	4028309	9023068
€ U.	151,35 1	161,78 1

Módulo de inspección
Inspection module
Module d'inspection

x1

ØD	80/125	100/150
Ref.	4028311	4023073
€ U.	78,93 1	84,21 1

Te giratoria H/H corta
Rotary "T" Piece F/F short
Té rotatif F/F court

x3

ØD	80/125	100/150
Ref.	4029297	4029296
€ U.	138,31 1	145,22 1

Abrazadera mural interior
Interior wall bracket
Bride murale intérieure

ØD	80/125	100/150
Ref.	4013902	2500039
€ U.	9,77 6	10,68 6

Abrazadera mural interior regulable
Interior adjustable wall bracket
Bride murale intérieure réglable

ØD	80/125	100/150
Ref.	4600702	4600703
€ U.	11,75 1	14,04 1

Abrazadera atornillada
Screwed bracket
Collier à vis

ØD	80/125	100/150
Ref.	4013908	2500025
€ U.	6,77 1	7,07 1

Abrazadera forjado reforzada
Interior wall bracket
Bride murale intérieure

ØD	80/125	100/150
Ref.	4028374	9023220
€ U.	33,64 1	34,05 1

Te giratoria M/H corta
Rotary "T" Piece M/F short
Té rotatif M/F court

x3

ØD	80/125	100/150
Ref.	4029302	4029293
€ U.	134,82 1	141,56 1

Te giratoria M/H larga
Rotary "T" Piece M/F long
Té giratoire M/F longue

x3

ØD	80/125	100/150
Ref.	4029301	4029299
€ U.	146,26 1	153,57 1

Te giratoria M/H reducida a 60 mm
Rotary "T" Piece M/F reduced to 60 mm
Té giratoire M/F réduit à 60 mm

x2

ØD	80/125	100/150
Ref.	9023071	9023070
€ U.	159,65 1	167,63 1

Adaptador biflujo
Two-way flow adapter
Adaptateur biflux

x1

ØD	80/125	100/150
Ref.	4040020	4040022
€ U.	103,68 1	121,54 1

Cubreaguas inoxidable horizontal
Horizontal stainless steel roof flashing
Solin inoxydable horizontal

+ collarín 75mm
+ storm collar 75mm
+ collerette 75mm

ØD	80/125	100/150
Ref.	4013886	2700868
€ U.	68,17 1	75,85 1

Cubreaguas inoxidable
Stainless steel roof flashing
Solin inoxydable

5°-25°

+ collarín 75mm
+ storm collar 75mm
+ collerette 75mm

ØD	80/125	100/150
Ref.	4026717	4026720
€ U.	137,86 1	140,73 1

Cubreaguas inoxidable
Stainless steel roof flashing
Solin inoxydable

25°-45°

+ collarín 75mm
+ storm collar 75mm
+ collerette 75mm

ØD	80/125	100/150
Ref.	4026733	4026736
€ U.	141,21 1	143,98 1

Cubreaguas inoxidable
Stainless steel roof flashing
Solin inoxydable

45° -60°

+ collarín 75mm
+ storm collar 75mm
+ collerette 75mm

ØD	80/125	100/150
Ref.	4026749	4026753
€ U.	155,04 1	159,58 1

Tapa de inspección
Inspection cover
Trappe d'inspection

200°C / 200 Pa

ØDint	80/125	100/150
Ref.	5003265	5003266
€ U.	18,75 1	19,01 1

Tapa
Cap
Tampon

ØD	80/125	100/150
Ref.	4028312	4020664
€ U.	57,10 1	59,82 1

Tapa purga
Condensate cap
Tampon récupérateur condensats

ØD	80/125	100/150
Ref.	4028313	4020465
€ U.	70,11 1	75,11 1

Soporte mural intermedio
Intermediate wall support
Support mural base

x1

ØD	80/125	100/150
Ref.	4028316	4023079
€ U.	58,22 1	61,25 1

8 DP

Doble Pared
Double Wall
Double Paroi

Ø80 - 350

Sombreros: antilluvia, antiretorno, giratorio, salida libre terminal sencillo, pico flauta y salida vertical
Caps: rain cap, non-return cap, wind directional cap, exhaust high cone, simple cap, flute peak cap and vertical outlet cap
Chapeaux: pare-pluie, antirefouleur, aspirateur, cône de finition haute, finition haute, chapeau de flûte et sortie verticale

2 Abrazadera vientos estática
Static roof brace band
Bride de haubanage statique

3 Collarín
Storm collar
Collerette

4 Cubreaguas: horizontal, 5-25°, 25-45°, 45-60°
Roof flashing: horizontal, 5-25°, 25-45°, 45-60°
Solins: horizontal, 5-25°, 25-45°, 45-60°

5 Soporte techo regulable
Adjustable roof support
Support au toit réglable

6 Módulo lineal 1.000, 500 y 250 mm
Linear module 1.000, 500 and 250 mm
Élément droit 1.000, 500 et 250 mm

7 Soporte mural exterior y extensiones de 150, 250, 500, 750 y 1.000 mm
Exterior wall support and expanders 150, 250, 500, 750 and 1.000 mm
Support mural extérieur et extensions de 150, 250, 500, 750 et 1.000 mm

8 Soporte mural intermedio, soporte mural base
Intermediate wall support, base wall support
Support mural intermédiaire, support mural de départ

9 Escuadras 150, 250 y 500 mm y escuadras reforzadas 750 y 1.000 mm
Squares 150, 250 and 500 mm and reinforced squares 750 and 1.000 mm
Équerres de 150, 250 et 500 mm et équerres renforcées de 750 et 1.000 mm

10 Codos 15°, 30°, 45°, 87°
Elbows 15°, 30°, 45°, 87°
Coudes 15°, 30°, 45°, 87°

11 Te 87°, adaptador caldera, paso mural extensible hasta 250 mm
"T" piece 87°, boiler adapter, extendable wall bushing up to 250 mm
Té 87°, adaptateur chaudière, élément traversée de mur, variable jusqu'à 250 mm

12 Módulo de limpieza oval 130x180 mm con tapa, te inspección
Oval cleaning module with cap 130x180 mm, inspection "T" piece
Module ramonage avec trappe ovale 130x180 mm, té inspection

13 Base inicial, tubos recortables y tapa condensación
Floor base, cut-out pipings and condensate cap
Plaque de départ, éléments recoupables et tampon purge

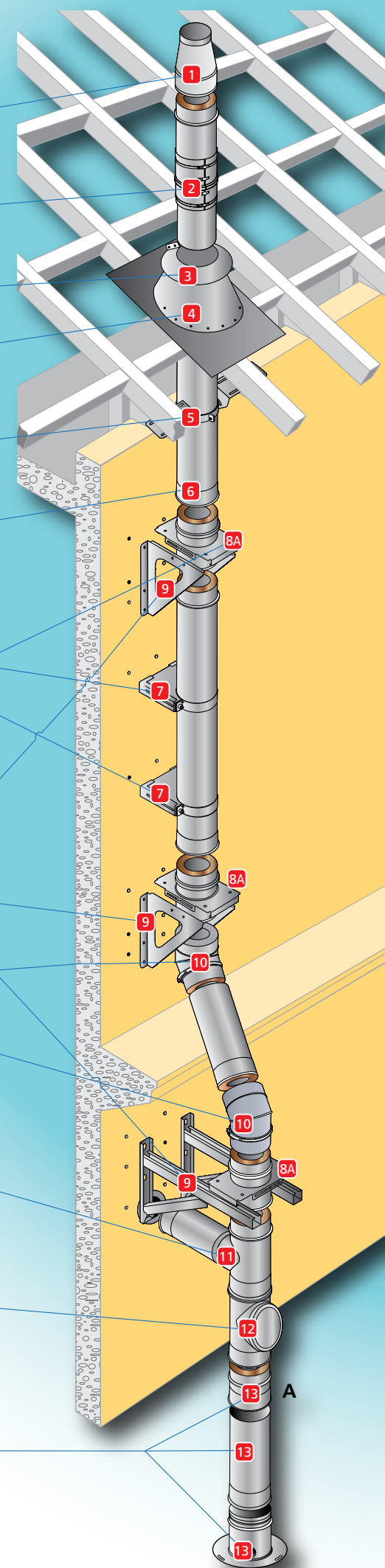

CE Especificaciones de acuerdo a la legislación europea en productos de construcción CPR
Specifications according to EU product regulations of construction CPR
Spécifications Selon la réglementation européenne concernant les produits de construction CPR

Espesor del aislante
Insulation thickness
Épaisseur d'isolation 25 mm
Lana de roca
Rock wool
Laine de roche

interior y exterior | inside and outside | intérieur et extérieur

AISI 304
(1.4301) 2R



EN 1856-1

Ø80-250
T200 P1 W Vm L20040 O(15)*
T200 N1 W Vm L20040 O(15)
T450 N1 W Vm L20040 O(40)
T600 N1 W Vm L20040 O(45)
T600 N1 D Vm L20040 G(70)

Ø300-350
T200 P1 W Vm L20050 O(15)*
T200 N1 W Vm L20050 O(15)
T450 N1 W Vm L20050 O(40)
T600 N1 W Vm L20050 G(45)
T600 N1 D Vm L20050 G(70)

interior | inside | intérieur

AISI 316L
(1.4404) 2R



exterior | outside | extérieur

AISI 304
(1.4301) 2R

EN 1856-1

Ø80-250
T200 P1 W V2 L50040 O(15)*
T200 N1 W V2 L50040 O(15)
T450 N1 W V2 L50040 O(40)
T600 N1 W V2 L50040 G(45)
T600 N1 D V2 L50040 G(70)

Ø300-350
T200 P1 W V2 L50050 O(15)*
T200 N1 W V2 L50050 O(15)
T450 N1 W V2 L50050 O(40)
T600 N1 W V2 L50050 G(45)
T600 N1 D V2 L50050 G(70)

interior | inside | intérieur

AISI 904L
(1.4539) 2R



exterior | outside | extérieur

AISI 304
(1.4301) 2R

Consulte el Departamento Comercial para más información
Consult Marketing Department for more information
Contactez le Service Commercial pour plus d'informations

* Para cumplir con esta designación todos los elementos deben estar instalados con juntas, consulte la página 86. Para saber el número de juntas, consulte la página 165.

* To comply with this designation, all elements must be installed with gaskets, see page 86. For the number of joints, see page 165.
* Pour respecter cette désignation, tous les éléments doivent être installés avec des joints, voir page 86. Unités de joints par élément, voir page 165.

Para el resto de elementos, la junta es opcional.
For all other elements, the gasket is optional.
Pour tous les autres éléments, le joint est optionnel.



Referencia	Ref.	2700172	Unidad de embalaje
Reference	Ref.	2700172	Packaging unit
Référence	Ref.	2700172	Unités par emballage
Precio unidad €	€ U.	79,12	
Unit price, €	€ U.	79,12	
Prix unité €	€ U.	79,12	

Módulo lineal y extensible
Pipe and extendable module
Élément droit e télescopique

Módulo lineal | Linear module | Élément droit



		ØDi mm			
		80	100	125	130
L 1000 mm					
AISI	Ref.	2700620	2700021	4013503	2700104
304-304	€ U.	56,51	62,12	71,70	72,64
AISI	Ref.	4015086	4015569	4016250	4016251
316L-304	€ U.	73,46	80,75	93,20	94,43
L 500 mm					
AISI	Ref.	2700621	2700020	4013502	2700103
304-304	€ U.	31,93	37,87	44,84	45,42
AISI	Ref.	4013603	4016254	4016255	4015051
316L-304	€ U.	41,51	49,22	58,29	59,06
L 250 mm					
AISI	Ref.	4007485	2700019	4013500	2700102
304-304	€ U.	24,35	26,74	32,94	33,38
AISI	Ref.	4013602	4016260	4016261	4016262
316L-304	€ U.	31,66	34,76	42,83	43,39
		ØDe mm			
		130	150	180	180

Módulo extensible | Extendable module | Élément télescopique



		ØDi mm			
		80	100	125	130
Lmin 500 mm - Lmax 900 mm					
AISI	Ref.	4008852	4008941	4013526	2700100
304-304	€ U.	91,26	98,96	107,10	108,50
AISI	Ref.	4013605	4016667	4016668	4016669
316L-304	€ U.	118,64	128,65	139,23	141,05
Lmin 335 mm - Lmax 565 mm					
AISI	Ref.	2700622	2700018	4013525	2700098
304-304	€ U.	62,81	67,51	79,55	80,59
AISI	Ref.	4012226	4016664	4016665	4015052
316L-304	€ U.	81,65	87,76	103,41	104,76
Lmin 200 mm - Lmax 300 mm					
AISI	Ref.	4007712	4008942	4013524	2700101
304-304	€ U.	42,43	49,28	53,53	54,24
AISI	Ref.	4013604	4016659	4016660	4016661
316L-304	€ U.	55,16	64,06	69,60	70,51

	150	180	200	250	300	350
2700172	2700226	2700275	2700334	2700390	2700427	
79,12	92,09	100,17	140,53	183,40	202,25	
4014573	4015912	4009371	4014574	4009452	4016252	
102,85	119,71	130,23	182,68	238,42	262,93	
2700171	2700225	2700274	2700333	2700389	2700426	
48,83	54,49	58,62	76,94	96,43	107,66	
4014488	4016257	4014489	4011636	4014742	4014404	
63,47	70,84	76,20	100,03	125,35	139,96	
2700170	2700224	2700273	2700332	2700388	2700425	
34,21	40,03	43,35	62,99	66,74	78,31	
4014490	4016263	4014491	4011774	4016264	4016265	
44,47	52,04	56,35	81,90	86,77	101,81	
		ØDe mm				
		200	230	250	300	400

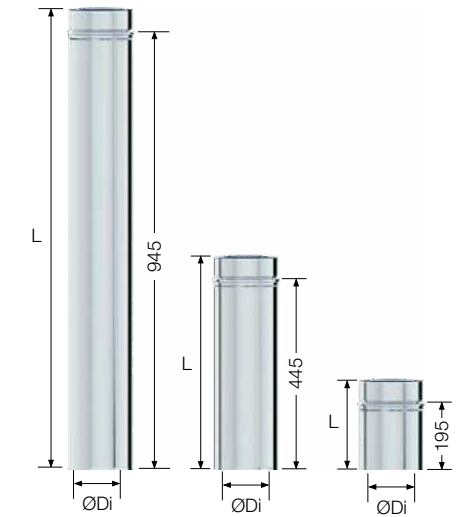

	150	180	200	250	300	350
2700168	2700222	2700271	2700331	2700386	2700424	
112,76	131,28	145,48	213,06	234,87	292,52	
4008377	4016670	4014500	4011772	4014743	4016671	
146,60	170,66	189,12	276,97	305,34	364,62	
2700166	2700220	2700269	2700329	2700385	2700423	
85,55	92,42	104,26	127,60	161,74	192,10	
4014495	4016666	4014365	4011773	4012406	4012421	
111,22	120,15	135,54	165,87	210,25	249,71	
2700169	2700223	2700272	4007715	2700387	4022030	
60,13	68,64	93,46	100,35	124,63	162,26	
4014496	4016662	4014497	4014499	4016663	4021191	
78,18	89,23	121,49	130,46	162,02	210,93	
		ØDe mm				
		200	230	250	300	400



Codo
Elbow
Coude

Codo | Elbow | Coude **15°**



		ØDi mm				
		80	100	125	130	
AISI	Ref.	4015142	4015143	4015144	4015145	
304-304	€ U.	34,78	36,79	41,54	41,54	
AISI	Ref.	4016570	4016571	4016572	4016573	
316L-304	€ U.	45,22	47,83	54,00	54,00	
Especificaciones técnicas Technical specifications Spécifications techniques						
		H	11	11	11	11
		V	123	126	130	130
		Ø	80	100	125	130
CDP 15°	H1	32	33	34	34	
	V1	245	250	258	258	
CDP 15° +1(500)+	H1	82	83	84	84	
	V1	433	438	445	445	
CDP 15° +1(1000)+	H1	147	148	149	149	
	V1	674	679	686	686	
CDP 15° +1(1000)+	H1	277	277	278	278	
	V1	1157	1162	1169	1169	

CDP : Codo Doble Pared | Double Wall elbow | Coude Double Paroi

	150	180	200	250	300	350
4015146	4015147	4015148	4015149	4015150	4015151	
46,11	55,04	59,17	70,20	108,47	138,93	
4016574	4016575	4016576	4016577	4016578	4016579	
59,95	71,54	76,92	91,27	141,01	180,60	
12	12	13	13	14	15	
132	136	139	145	152	158	
		ØDe mm				
		200	230	250	300	400
35	36	36	38	40	41	
263	271	276	289	302	315	
85	86	87	88	90	92	
450	458	463	476	489	502	
150	151	151	153	155	156	
692	699	705	718	730	743	
279	280	281	282	284	286	
1175	1182	1187	1200	1213	1226	

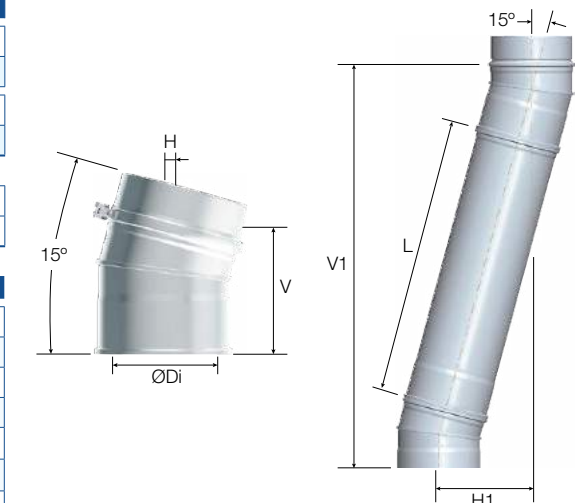

Referencia Référence Référence	Ref.	2700162	Unidad de embalaje Packaging unit Unités par emballage
Precio unidad € Unit price, € Prix unité €	€ U.	50,15 1	

Codo
Elbow
Coude

Codo | Elbow | Coude 30°



		ØDi mm			
		80	100	125	130
AISI 304-304	Ref.	4008007	2700015	4013538	2700094
	€ U.	37,84 1	40,02 1	44,61 1	45,20 1
AISI 316L-304	Ref.	4015622	4016580	4016581	4016582
	€ U.	49,18 1	52,02 1	57,99 1	58,75 1
Especificaciones técnicas Technical specifications Spécifications techniques					
H		25	26	28	28
V		136	141	148	148
		Ø			
		80	100	125	130
CDP 30° + CDP 30°	H1	71	74	78	78
	V1	266	276	290	290
CDP 30° + L(250) + CDP 30°	H1	168	171	175	175
	V1	434	444	458	458
CDP 30° + L(500) + CDP 30°	H1	293	296	300	300
	V1	651	661	675	675
CDP 30° + L(1000) + CDP 30°	H1	543	546	550	550
	V1	1084	1094	1108	1108

CDP: Codo Doble Pared | Double Wall elbow | Coude Double Paroi

Codo | Elbow | Coude 45°



		ØDi mm			
		80	100	125	130
AISI 304-304	Ref.	2700624	2700016	4013539	2700095
	€ U.	40,50 1	42,04 1	47,11 1	47,73 1
AISI 316L-304	Ref.	4015063	4016586	4016587	4015053
	€ U.	52,65 1	54,66 1	61,24 1	62,05 1
Especificaciones técnicas Technical specifications Spécifications techniques					
H		42	43	47	47
V		145	151	161	161
		Ø			
		80	100	125	130
CDP 45° + CDP 45°	H1	110	116	123	123
	V1	276	290	309	309
	H2	221	231	245	245
CDP 45° + L(250) + CDP 45°	H1	244	249	257	257
	V1	417	431	450	450
	H2	362	372	385	386
CDP 45° + L(500) + CDP 45°	H1	416	421	429	429
	V1	598	612	631	631
	H2	543	553	567	567
CDP 45° + L(1000) + CDP 45°	H1	760	765	773	773
	V1	961	975	994	994
	H2	906	915	929	929
V2	H2	863	872	885	886

CDP: Codo Doble Pared | Double Wall elbow | Coude Double Paroi

Codo | Elbow | Coude 87°



		ØDi mm			
		80	100	125	130
AISI 304-304	Ref.	4021737	4021739	4021740	4021741
	€ U.	76,11 1	79,34 1	85,21 1	86,54 1
AISI 316L-304	Ref.	4019668	4019669	4020187	4019671
	€ U.	90,11 1	95,44 1	107,96 1	111,02 1
Especificaciones técnicas Technical specifications Spécifications techniques					
H		114	124	137	137
V		163	173	187	187

150	180	200	250	300	350
2700162	2700215	2700264	2700324	2700380	2700419
50,15 1	59,86 1	64,36 1	76,35 1	117,99 1	151,09 1
4014553	4016583	4014576	4011638	4009453	4016585
65,20 1	77,82 1	83,67 1	99,26 1	153,38 1	196,42 1
29	32	33	36	40	43
153	161	166	178	191	203
150	180	200	250	300	350
80	85	87	94	101	107
300	315	325	350	375	400
177	181	184	191	197	204
468	483	493	518	543	568
302	306	309	316	322	329
685	700	710	735	760	785
552	556	559	566	572	579
1118	1133	1143	1168	1193	1218

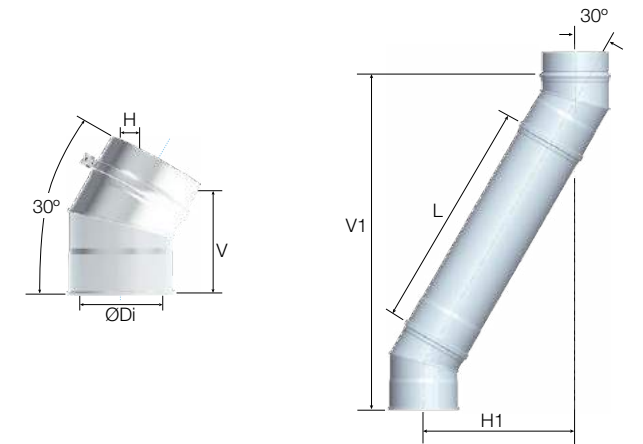

150	180	200	250	300	350
2700163	2700217	2700265	2700325	2700381	2700420
53,08 1	67,51 1	72,89 1	90,13 1	133,99 1	173,39 1
4008379	4016588	4012119	4011639	4012423	4012422
69,01 1	87,76 1	94,76 1	117,15 1	174,18 1	225,41 1
50	54	57	63	70	77
167	178	185	202	219	236
150	180	200	250	300	350
129	137	143	156	170	184
323	344	358	392	426	461
255	270	280	305	330	355
246	259	269	292	316	340
262	271	276	290	304	317
464	485	498	533	567	602
396	411	420	445	470	495
379	393	402	426	450	473
434	443	448	462	476	489
645	666	679	714	748	783
577	592	602	627	652	677
551	565	574	598	622	645
779	787	792	806	820	834
1008	1029	1042	1077	1111	1146
939	954	964	989	1014	1039
895	909	919	942	966	990

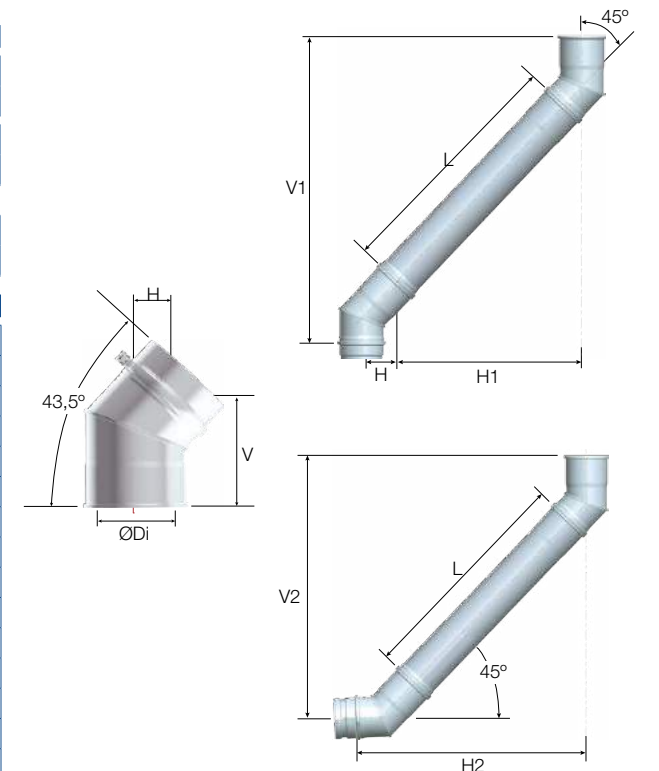

150	180	200	250	300	350
4021742	4021743	4021744	4021745	4021746	4021749
96,49 1	117,20 1	122,95 1	151,38 1	186,78 1	215,35 1
4019672	4019673	4019674	4019675	4019676	4019677
118,44 1	145,55 1	151,05 1	198,72 1	236,40 1	264,26 1
146	160	170	194	217	241
197	212	222	247	272	297

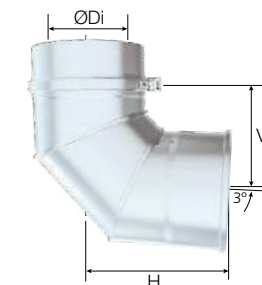

Adaptador
Adapter
Adaptateur

Adaptador caldera exterior | Exterior boiler adapter | Adaptateur chaudière extérieure



		ØDi mm		80	100	125	130	150
AISI 304-304	Ref.	4007628	2700011	4013903	2700084	2700152		
	€ U.	28,42	33,39	38,86	39,38	42,03		
AISI 316L-304	Ref.	4013783	4015572	4016619	4015054	4014557		
	€ U.	36,95	43,41	50,51	51,18	54,65		

Adaptador caldera interior | Interior boiler adapter | Adaptateur chaudière intérieure



		ØDi mm		80	100	125	130	150
AISI 304-304	Ref.	4027054	4027056	4027057	4027058	4027059		
	€ U.	32,70	37,39	40,09	41,49	44,79		

Adaptador caldera antihollín | Anti-soot boiler adapter | Adaptateur chaudière anti-bistres



		ØDi mm		80	100	125	130	150
AISI 316L-304	Ref.	-	4025410	4025411	4025412	4025413		
	€ U.	-	48,45	52,27	52,41	55,32		

Adaptador SP - DP | SW - DW Adapter | Adaptateur SP - DP



		ØDi mm		80	100	125	130	150
AISI 304-304	Ref.	4007484	2700013	4013792	2700092	2700160		
	€ U.	26,66	27,73	32,38	32,81	36,25		
AISI 316L-304	Ref.	4012225	4016601	4016602	4015766	4014568		
	€ U.	34,66	38,83	45,33	45,92	51,34		

Adaptador DP - SP | DW - SW Adapter | Adaptateur DP - SP



		ØDi mm		80	100	125	130	150
AISI 304-304	Ref.	4010098	4008853	4013798	2700090	2700158		
	€ U.	26,66	27,28	33,53	33,96	37,31		
AISI 316L-304	Ref.	4015108	4016622	4016623	4015055	4014570		
	€ U.	34,66	35,46	43,58	44,16	48,50		

Paso mural extensible | Extendable wall bushing | Traversée de mur télescopique



		ØDi mm		80	100	125	130	150
AISI 304-304	Ref.	4021950	4021951	4021949	4021952	4021953		
	€ U.	68,58	75,62	78,78	83,25	86,86		
AISI 316L-304	Ref.	4019903	4019906	4019907	4019908	4019909		
	€ U.	82,29	90,75	98,13	99,91	104,23		

Paso mural | Wall bushing | Traversée de mur



		ØDi mm		80	100	125	130	150
AISI 304-304	Ref.	-	-	-	4021941	4021943		
	€ U.	-	-	-	60,01	62,14		
AISI 316L-304	Ref.	-	-	-	4020705	4020706		
	€ U.	-	-	-	72,01	74,57		

Paso forjado | Ceiling bushing | Traversée de toit 500 mm



		ØDi mm		80	100	125	130	150
AISI 316L-304	Ref.	4036073	4036074	4033781	4036075	4033782		
	€ U.	55,94	58,84	62,65	63,60	67,84		

Te | "T" piece | Té 90° *



		ØDi mm		80	100	125	130	150
AISI 304-304	Ref.	4021799	4021800	4021801	4021802	4021803		
	€ U.	61,68	69,25	75,22	76,49	78,05		
AISI 316L-304	Ref.	4019993	4019994	4020162	4019996	4019997		
	€ U.	80,16	90,02	97,79	99,44	105,56		

Especificaciones técnicas | Technical specifications | Spécifications techniques

	L	H	V
	288	144	159
	321	161	169
	338	169	183
	338	169	183
	358	179	193

Referencia Reference Référence	Ref.	2700152	Unidad de embalaje Packaging unit Unités par emballage
Precio unidad € Unit price, € Prix unité €	€ U.	42,03	1

		180	200	250	300	350
2700210	Ref.	2700259	2700319	2700822	2700877	
	€ U.	49,17	54,51	61,60	86,95	106,09
4016620	Ref.	4014606	4014607	4009454	4016621	
	€ U.	63,92	70,86	80,09	113,04	138,02

		180	200	250	300	350
4027060	Ref.	4027061	4027062	4027063	4027064	
	€ U.	51,26	57,10	64,68	91,30	117,41

		180	200	250	300	350
4025414	Ref.	4025415	4025416	-	-	
	€ U.	68,51	71,87	82,48	-	-

		180	200	250	300	350
2700213	Ref.	2700262	2700322	2700825	4008960	
	€ U.	44,13	47,06	59,19	94,18	114,94
4015915	Ref.	4014579	4014569	4023385	4014405	
	€ U.	61,77	65,88	76,95	122,44	149,41

		180	200	250	300	350
2700211	Ref.	2700260	2700320	2700823	2700876	
	€ U.	42,56	48,04	59,76	95,05	113,82
4016624	Ref.	4014580	4014571	4015040	4016625	
	€ U.	55,33	62,45	73,48	120,31	147,23

		180	200	250	300	350
4021954	Ref.	4021955	4021956	-	-	
	€ U.	96,25	99,56	119,52	-	-
4019910	Ref.	4019911	4019912	-	-	
	€ U.	115,50	119,47	143,43	-	-

		180	200	250	300	350
4021944	Ref.	4021946	4021947	-	-	
	€ U.	65,54	68,31	78,25	-	-
4020708	Ref.	4020709	4020710	-	-	
	€ U.	78,65	81,98	93,92	-	-

		180	200	250	300	350
4036076	Ref.	4036077	4036078	-	-	
	€ U.	71,02	74,20	90,10	-	-

		180	200	250	300	350
4021804	Ref.	4021805	4021807	4021809	4021810	
	€ U.	94,80	106,69	140,85	192,94	243,66
4019998	Ref.	4019999	4020000	4020002	4020003	
	€ U.	123,24	138,70	183,09	250,83	316,75

	388	408	488	508	558
	194	204	244	254	279
	208	218	243	268	293

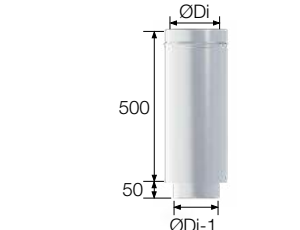
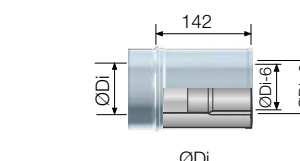
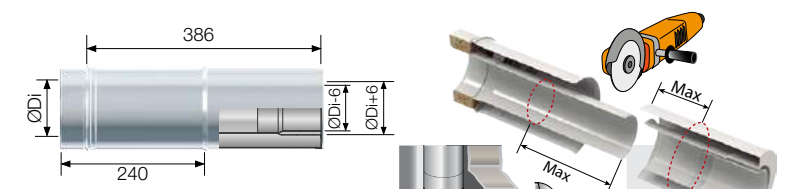
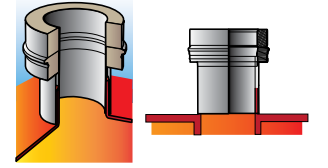
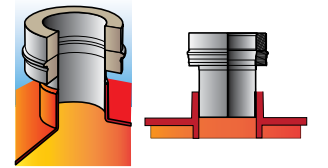
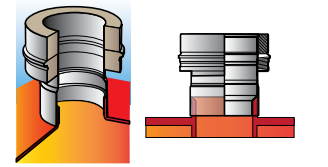
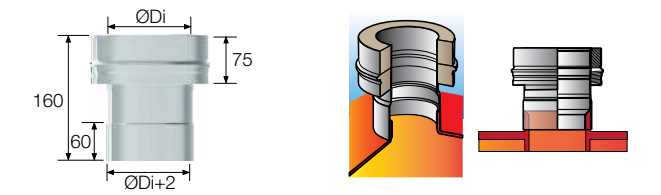

* No incluye tapas
No caps included
Tampons non compris

Te y tapa
"T" Piece and cover
Té et tampon

Te y Tapa
"T" Piece and Cover
Té et Tampon

Te | "T" piece | Té 93° *



		ØDi mm			
		80	100	125	130
AISI 304-304	Ref.	4019569	4019570	4019571	4019572
	€ U.	61,68	69,25	75,22	76,49
AISI 316L-304	Ref.	4021755	4021756	4021758	4021759
	€ U.	80,16	90,02	97,79	99,44

Especificaciones técnicas Technical specifications Spécifications techniques					
L		287	320	337	337
V		138	154	161	161
H		162	173	187	187

* No incluye tapas | No caps included | Tampons non compris

Te | "T" piece | Té 135° *



		ØDi mm			
		80	100	125	130
AISI 304-304	Ref.	4021770	4021772	4021773	4021774
	€ U.	80,05	107,35	116,29	118,08
AISI 316L-304	Ref.	4021783	4021786	4021787	4021788
	€ U.	126,14	162,80	178,54	180,88

Especificaciones técnicas Technical specifications Spécifications techniques					
L		340	369	404	411
V		52	59	68	68
H		185	202	225	225

* No incluye tapas | No caps included | Tampons non compris

Tapa | Cap | Tampon



		ØDi mm			
		80	100	125	130
AISI 304-304	Ref.	4008165	2700027	4023279	2700110
	€ U.	17,00	17,89	21,05	21,05
AISI 316L-304	Ref.	4015925	4015931	4025161	4015937
	€ U.	22,11	23,26	26,69	27,38

Tapa purga | Condensate cap | Tampon récupérateur condensats



		ØDi mm			
		80	100	125	130
AISI 304-304	Ref.	4011090	2700028	4021522	2700111
	€ U.	21,62	22,52	23,78	23,78
AISI 316L-304	Ref.	4015936	4015575	4020053	4015943
	€ U.	28,10	29,26	30,52	30,52

Especificaciones técnicas Technical specifications Spécifications techniques					
ØG		1/2"	1/2"	1/2"	1/2"

Referencia Reference Référence	Ref.	4019573	Unidad de embalaje Packaging unit Unités par emballage
Precio unidad € Unit price, € Prix unité €	€ U.	78,05	1

	150	180	200	250	300	350
4019573	78,05	94,80	106,69	140,85	192,94	243,66
4021761	105,56	123,24	138,70	183,09	250,83	316,75
	357	387	407	487	507	557
	171	185	194	233	242	265
	198	214	224	251	277	303

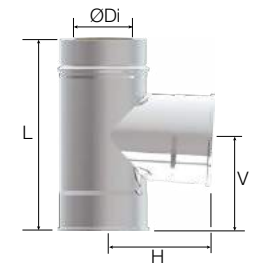

	150	180	200	250	300	350
4021776	138,04	141,86	171,26	268,34	333,51	364,25
4021789	208,49	218,91	258,47	396,99	496,56	554,77
	439	478	507	577	648	719
	76	86	93	111	129	146
	243	268	285	328	371	413



	150	180	200	250	300	350
2700178	22,34	26,53	27,56	37,05	48,47	62,50
4015938	29,05	34,49	35,82	48,17	63,01	81,25

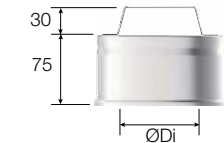

	150	180	200	250	300	350
2700179	25,15	29,38	30,77	39,90	51,80	65,92
4015952	32,70	38,18	39,99	51,87	66,52	83,65
	3/4"	3/4"	3/4"	3/4"	1"	1"

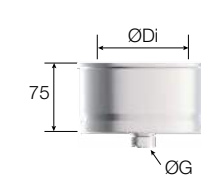

Sifón | Siphon | Siphon



Ref.	4030741
€ U.	29,15

max. 160° C

Te reducida
"T" Piece reduced
Té réduit

Te reducida con admisión de aire a | Reduction "T" Piece air inlet to | Té réduit avec prise d'air à



60 / 100 mm

		ØDi mm			
		80	100	125	130
AISI 304-304	Ref.	-	-	4022102	4022103
	€ U.	-	-	101,49	102,49
AISI 316L-304	Ref.	-	-	4022105	4022106
	€ U.	-	-	129,73	130,81

Te reducida con admisión de aire a | Reduction "T" Piece air inlet to | Té réduit avec prise d'air à



80 / 125 mm

		ØDi mm			
		80	100	125	130
AISI 316L-304	Ref.	-	-	9022111	9022112
	€ U.	-	-	123,27	126,56

Te reducida a | "T" Piece reduced to | Té réduit à



80 mm

		ØDi mm			
		80	100	125	130
AISI 304-304	Ref.	-	4017400	4013897	4010519
	€ U.	-	101,84	110,78	110,78
AISI 316L-304	Ref.	-	4017416	4017418	4017419
	€ U.	-	132,78	143,93	145,83

	150	180	200	250	300	350
4015152	105,69	110,81	114,57	137,48	148,28	-
4022107	133,33	139,92	142,53	170,48	187,50	-



	150	180	200	250	300	350
4022113	127,80	135,59	137,93	176,60	204,13	-



	150	180	200	250	300	350
4009016	119,05	133,33	143,80	159,26	174,14	-
4017420	162,20	182,74	201,80	228,65	252,01	-

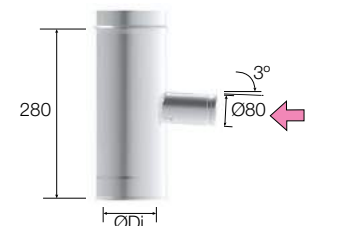

Módulo de inspección
Inspection module
Module d'inspection

Módulo de limpieza oval con tapa | Oval cleaning module with cap | Module ramonage ovale avec trappe



		ØDi mm			
		80	100	125	130
AISI 316L-304	Ref.	-	-	-	4017264
	€ U.	-	-	-	234,40 1

Módulo de inspección | Inspection module | Module inspection *



		ØDi mm			
		80	100	125	130
AISI 304-304	Ref.	4021847	4021848	4022492	4021850
	€ U.	93,94 1	95,02 1	110,44 1	115,73 1
AISI 316L-304	Ref.	4020059	4020060	4022493	4020061
	€ U.	104,10 1	110,55 1	114,83 1	125,36 1

Especificaciones técnicas Technical specifications Spécifications techniques					
L		288	321	338	338
ØT		80	100	130	130

Codo inspección | Inspection elbow | Coude inspection



		ØDi mm			
		80	100	125	130
AISI 304-304	Ref.	4023726	4023728	4023729	4023731
	€ U.	136,73 1	140,34 1	149,48 1	157,06 1
AISI 316L-304	Ref.	4019914	4019915	4020163	4019917
	€ U.	156,65 1	160,78 1	171,25 1	179,94 1

Especificaciones técnicas Technical specifications Spécifications techniques					
H		141	154	171	171
V		192	205	223	223
ØT		80	100	130	130

Tapa
Cover
Trappe

Tapa de inspección | Inspection cover | Trappe d'inspection



Resistente a condensados
Condensate-resistant
Résistante aux condensats

		200°C / 200 Pa			
		ØDi mm			
		80	100	125	130
Ref.		5003265	5003266	5003267	5003267
	€ U.	18,75 1	19,01 1	22,29 1	22,29 1

Tapa de inspección | Inspection cover | Trappe d'inspection



Para combustibles sólidos
For solid fuels
Pour combustibles solides

		450°C / 40 Pa			
		ØDi mm			
		80	100	125	130
Ref.		5003391	5003392	5003393	5003393
	€ U.	26,23 1	30,29 1	34,26 1	34,26 1

Fijación al suelo
Floor fastening
Fixation au sol

1 Tapa condensación | Condensate cap | Tampon récupérateur condensats



		ØDi mm			
		80	100	125	130
AISI 316L-304	Ref.	4019962	4019963	4022046	4019965
	€ U.	40,94 1	42,92 1	45,37 1	46,26 1

Especificaciones técnicas Technical specifications Spécifications techniques					
ØG		1/2"	1/2"	1/2"	1/2"

2 Tubo recortable | Cut-out piping | Élément recoupable

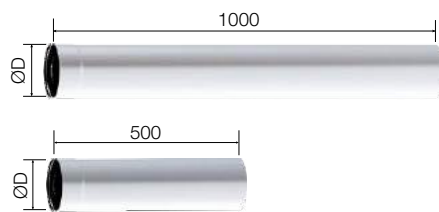

		500 mm, 1000 mm			
		ØDi mm			
		80	100	125	130
AISI 304	Ref.	4019895	4019896	4019897	4019897
	€ U.	35,30 1	38,44 1	50,19 1	50,19 1
AISI 304	Ref.	4019885	4019886	4019887	4019887
	€ U.	25,63 1	27,19 1	27,91 1	27,91 1

3 Base inicial con salida lateral | Floor base with lateral outlet | Plaque de départ avec sortie latérale



		ØDi mm			
		80	100	125	130
AISI 304	Ref.	4021875	4021876	4019971	4019971
	€ U.	21,75 1	22,35 1	25,32 1	25,32 1

Referencia Reference Référence	Ref.	4017265	Unidad de embalaje Packaging unit Unités par emballage
Precio unidad € Unit price, € Prix unité €	€ U.	238,73 1	

	150	180	200	250	300	350
4017265	4017266	4017267	4017268	-	-	-
238,73 1	255,33 1	265,49 1	294,30 1	-	-	-

	150	180	200	250	300	350
4021851	4021852	4021853	4021854	4021855	4021856	
121,27 1	141,03 1	161,34 1	172,40 1	208,65 1	234,72 1	
4020062	4020063	4020064	4020065	4020066	4020067	
131,71 1	153,93 1	174,53 1	187,98 1	246,75 1	262,15 1	

358	388	408	488	508	558
150	180	200	250	300	300

	150	180	200	250	300	350
4023732	4023735	4023736	4023737	4023738	4023739	
165,00 1	197,97 1	210,84 1	240,46 1	257,10 1	263,44 1	
4019918	4019919	4019920	4019921	4019922	4022032	
189,02 1	226,80 1	241,55 1	275,48 1	294,54 1	301,81 1	

183	201	214	244	275	307
236	255	268	300	333	366
150	180	200	250	300	300

	150	180	200	250	300	350
5003268	5003269	5003270	5003271	5003272	5003272	
24,61 1	32,36 1	35,07 1	51,53 1	63,41 1	63,41 1	

	150	180	200	250	300	350
5003394	5003395	5003396	5003397	5003398	5003398	
38,33 1	44,04 1	48,67 1	72,14 1	88,77 1	88,77 1	

	150	180	200	250	300	350
4019966	4019967	4019968	4019969	4019970	4023751	
48,95 1	52,15 1	54,89 1	72,62 1	91,96 1	107,23 1	

3/4"	3/4"	3/4"	3/4"	3/4"	3/4"
------	------	------	------	------	------

	150	180	200	250	300	350
4019898	4019899	4019900	4019901	4022057	4022058	
53,45 1	65,69 1	72,98 1	92,15 1	120,27 1	132,64 1	

	150	180	200	250	300	350
4019888	4019889	4019890	4019891	4022050	4022056	
30,76 1	36,30 1	37,96 1	53,24 1	69,48 1	76,63 1	

	150	180	200	250	300	350
4019973	4019974	4019975	4019977	4019978	4022033	
26,47 1	27,92 1	34,35 1	41,62 1	43,56 1	49,69 1	

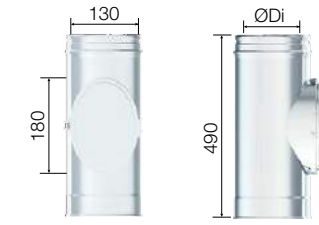

* No incluye tapas | No caps included | Tampons non compris

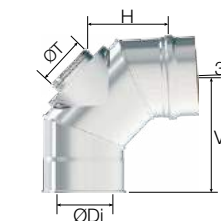

* No incluye tapas | No caps included | Tampons non compris

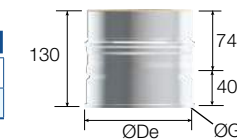
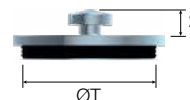
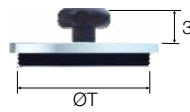

Sifón | Siphon | Siphon



Ref.	4030741
€ U.	29,15 1

max. 160°C

Alternativas de montaje de la base inicial | Alternative floor base mounting Possibilités de montage de la plaque de départ au sol

Montaje | Mounting | Montage 1
Con tubo recortable | With cut-out piping | Avec tuyau recoupable
El tubo recortable puede ser cortado a medida para que encaje perfectamente entre el suelo y la te de conexión a la caldera.
The cutout tube can be cut to fit perfectly between the floor and connection "T" piece to boiler.
L'élément recoupable peut être coupé sur mesure pour s'emboîter parfaitement entre le sol et le té de raccordement à la chaudière.

Montaje | Mounting | Montage 2
Sin tubo recortable
Without cut-out piping
Sans élément recoupable

Regulador de tiro
Draft regulator
Modérateur de tirage

Regulador de tiro | Draft regulator | Modérateur de tirage

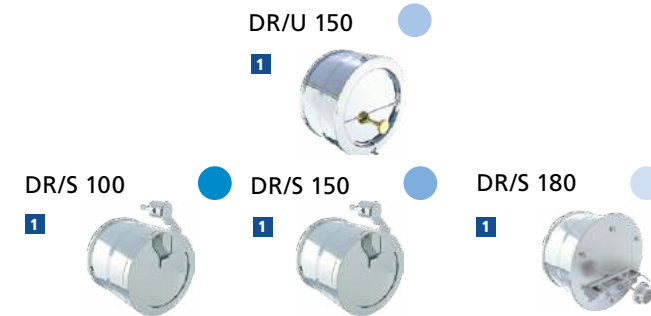

ØDi mm	80	100	125	130
	DR/U 150			
Ref.	-	-	-	4025728
€ U.	-	-	-	120,31 1
	DR/S 100			
Ref.	4025731	4025732	4025733	4025734
€ U.	170,79 1	174,40 1	175,62 1	191,32 1

Referencia	Ref.	4025729	Unidad de embalaje
Reference	Ref.	4025729	Packaging unit
Référence	Ref.	4025729	Unités par emballage
Precio unidad €	€ U.	122,37 1	
Unit price, €	€ U.	122,37 1	
Prix unité €	€ U.	122,37 1	

150	180	200	250	
4025729	4025730	-	-	
122,37 1	125,68 1	-	-	
	DR/S 180			
Ref.	4025735	4025736	4025737	4025738
€ U.	193,23 1	325,32 1	339,67 1	354,97 1

Montaje del Moderador de tiro Draft regulator assembly Montage du modérateur de tirage

1 Montado en una Te de 90°. Vea la ilustración
Mounted on a 90° "T" Piece. See the image
Se monte sur un Té 90°. Voir illustration.

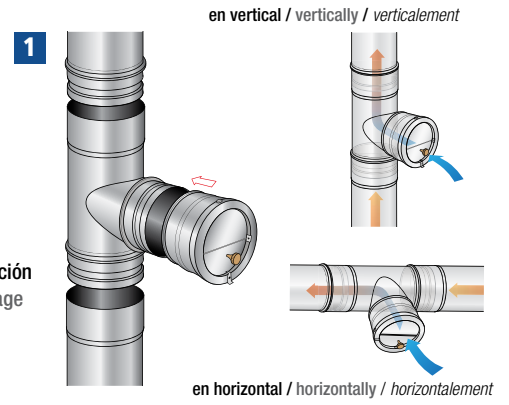

Soporte
Support
Support

Soporte mural base | Base wall support | Support mural de départ



ØDi mm	80	100	125	130
AISI 316L-304	Ref. 4019804	4019805	4022059	4019808
€ U.	57,79 1	62,26 1	65,44 1	68,93 1
Especificaciones técnicas Technical specifications Spécifications techniques				
A	165	185	210	215
B	245	265	290	295
ØG	1/2"	1/2"	1/2"	3/4"

Soporte mural intermedio | Intermediate wall support | Support mural intermédiaire



ØDi mm	80	100	125	130
AISI 316L-304	Ref. 4020107	4020108	4022061	4020109
€ U.	53,77 1	57,87 1	61,22 1	64,49 1
Especificaciones técnicas Technical specifications Spécifications techniques				
A	165	185	210	215
B	245	265	290	295

Soporte forjado DP - DP | DW - DW ceiling support | Plaque plancher DP - DP



ØDi mm	80	100	125	130
AISI 304-304	Ref. 4009218	2700961	4013901	2700962
€ U.	65,22 1	67,45 1	75,29 1	76,29 1
AISI 316L-304	Ref. 4016383	4016384	4016385	4016386
€ U.	78,26 1	80,96 1	90,34 1	91,55 1
Especificaciones técnicas Technical specifications Spécifications techniques				
A	330	350	375	380

Soporte forjado DP - SP | DW - SW ceiling support | Plaque plancher DP - SP



ØDi mm	80	100	125	130
AISI 304-304	Ref. 4015126	4015127	4015128	4015129
€ U.	62,23 1	63,53 1	70,91 1	71,85 1
AISI 316L-304	Ref. 4016387	4016389	4016390	4016258
€ U.	74,68 1	76,24 1	85,10 1	86,22 1
Especificaciones técnicas Technical specifications Spécifications techniques				
A	330	350	375	380

150	180	200	250	300	350
4019809	4019811	4019812	4019813	4019814	4019815
76,15 1	83,45 1	88,98 1	102,53 1	119,39 1	129,98 1
235	263	283	333	383	433
315	343	363	413	463	513
3/4"	3/4"	3/4"	3/4"	3/4"	1"

150	180	200	250	300	350
4020110	4020111	4020112	4020113	4020114	4020115
70,83 1	77,56 1	82,44 1	93,88 1	108,76 1	116,20 1
235	263	283	333	383	433
315	343	363	413	463	513

150	180	200	250	300	350
2700963	2700964	2700965	2700966	2700833	4009285
84,62 1	95,73 1	102,10 1	113,77 1	147,47 1	174,43 1
4014544	4016388	4014545	4014549	4016391	4016392
101,56 1	114,88 1	122,53 1	136,54 1	176,95 1	209,32 1
400	430	450	500	550	600

150	180	200	250	300	350
4015130	4010338	4015131	4015132	4015133	4015134
79,70 1	90,16 1	96,15 1	107,15 1	127,74 1	153,20 1
4016416	4016417	4016418	4016419	4016420	4016421
95,64 1	108,18 1	115,39 1	128,58 1	153,29 1	183,84 1
400	430	450	500	550	600

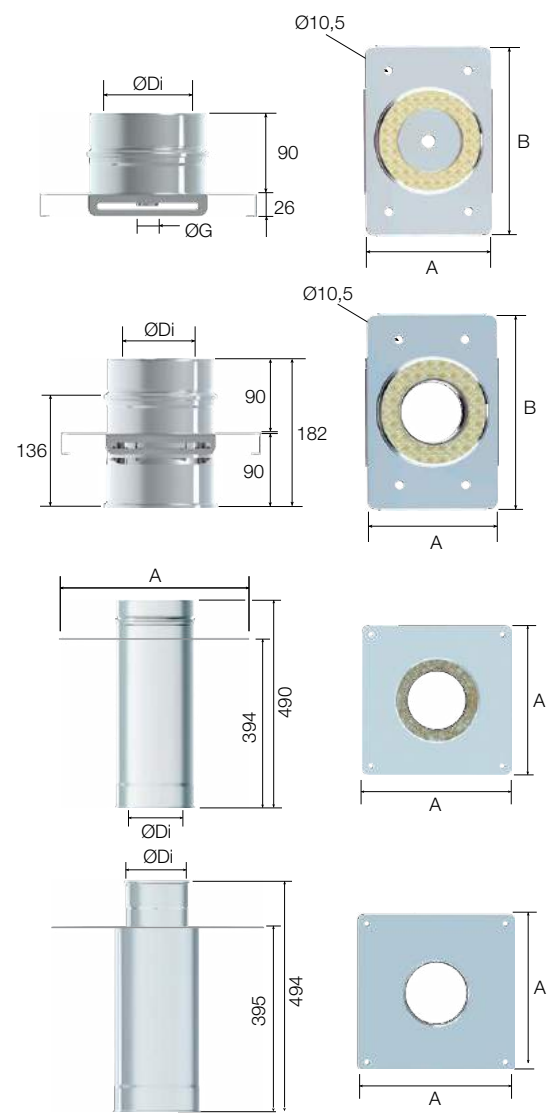

Sombrero
Cap
Cap

Sombrero antilluvia | Rain cap | Chapeau pare-pluie



ØDi mm	80	100	125	130
AISI 304-304	Ref. 2700625	2700023	4013722	2700106
€ U.	32,29 1	35,99 1	44,61 1	45,20 1
AISI 316L-304	Ref. 4013784	4016434	4016435	4016436
€ U.	41,97 1	46,77 1	57,99 1	58,75 1
Especificaciones técnicas Technical specifications Spécifications techniques				
V	143	143	143	143
ØDs	250	250	300	300

150	180	200	250	300	350
2700174	2700228	2700277	2700336	2700392	2700879
45,86 1	58,70 1	62,51 1	75,44 1	129,90 1	160,95 1
4008380	4015399	4012122	4014558	4016437	4016438
59,62 1	76,31 1	81,26 1	98,07 1	168,87 1	209,23 1
143	143	143	180	180	193
300	350	400	500	550	600

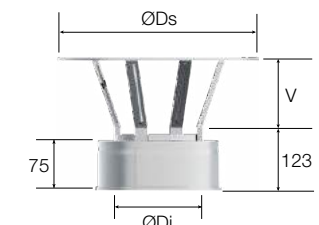

Referencia Reference Référence	Ref.	2700175	Unidad de embalaje Packaging unit Unités par emballage
Precio unidad € Unit price, € Prix unité €	€ U.	88,45 1	

Sombrero
Cap
Cap

Sombrero antiretorno | Non-return cap | Chapeau anti-refoulement



		ØDi mm			
		80	100	125	130
AISI 304-304	Ref.	2700626	2700024	4013723	2700107
	€ U.	56,87 1	69,23 1	73,80 1	78,25 1
AISI 316L-304	Ref.	4015062	4015573	4016448	4016449
	€ U.	68,25 1	83,07 1	88,56 1	93,91 1

Especificaciones técnicas | Technical specifications | Spécifications techniques

		80	100	125	130
H		265	265	265	265
U		142	142	142	142
ØDs		180	200	230	230

Sombrero giratorio | Wind directional cap | Chapeau aspirateur



		ØDi mm			
		80	100	125	130
AISI 304-304	Ref.	-	-	4013729	2700872
	€ U.	-	-	202,08 1	204,72 1
AISI 316L-304	Ref.	-	-	4016472	4016473
	€ U.	-	-	257,60 1	260,97 1

Especificaciones técnicas | Technical specifications | Spécifications techniques

		80	100	125	130
H		-	-	415	415
ØDs		-	-	175	175

Sombrero salida libre | Exhaust high cone | Cône de finition haute



		ØDi mm			
		80	100	125	130
AISI 304-304	Ref.	4015140	2700025	4013731	2700108
	€ U.	33,58 1	34,72 1	38,07 1	38,57 1
AISI 316L-304	Ref.	4016458	4016459	4016460	4016461
	€ U.	43,65 1	45,13 1	49,49 1	50,14 1

Sombrero terminal sencillo | Simple cap | Chapeau finition haute



		ØDi mm			
		80	100	125	130
AISI 304-304	Ref.	4012223	4015141	4013732	2700112
	€ U.	17,46 1	19,29 1	20,81 1	21,08 1
AISI 316L-304	Ref.	4016487	4016488	4016489	4016490
	€ U.	22,69 1	25,08 1	27,05 1	27,41 1

Sombrero pico flauta | Flute peak cap | Chapeau de flûte



		ØDi mm			
		80	100	125	130
AISI 316L-304	Ref.	4014044	4009839	4013730	4007530
	€ U.	58,25 1	65,17 1	70,98 1	71,92 1

Sombrero salida vertical | Vertical outlet cap | Chapeau sortie verticale



		ØDi mm			
		80	100	125	130
AISI 304-304	Ref.	4014650	4014651	4014652	4014653
	€ U.	94,00 1	104,35 1	113,84 1	120,74 1
AISI 316L-304	Ref.	4014655	4014656	4014657	4014658
	€ U.	106,82 1	118,58 1	129,36 1	137,20 1

Junta silicona | Silicone gasket | Joint silicone



		ØDi mm			
		80	100	125	130
Ref.		5003948	5003950	5003951	5003951
€ U.		1,00 10	1,09 10	1,38 10	1,38 10

Junta cerámica autoadhesiva | Self-adhesive ceramic gasket | Joint autoadhésif en céramique



		Øm			
		80	100	125	130
Ref.	2053351				
€ m.	2,46 1				

Especificaciones técnicas | Technical specifications | Spécifications techniques

		80	100	125	130
m (desarrollo)		0,25	0,31	0,39	0,41

Precio del metro lineal | Price per linear metre | Prix par mètre linéaire

150	180	200	250	300	350
2700175	2700229	2700278	2700337	2700832	2700881
88,45 1	99,82 1	107,95 1	136,91 1	155,54 1	210,44 1
4014559	4016450	4014560	4014561	4016451	4016452
106,14 1	119,78 1	129,54 1	164,29 1	186,64 1	252,54 1
265	265	323	323	323	323
142	142	200	200	200	200
250	280	350	400	450	500

150	180	200	250	300	350
2700873	2700874	2700875	2700887	2700888	2700889
228,34 1	252,87 1	280,16 1	307,97 1	380,07 1	490,28 1
4014563	4016474	4014564	4014565	4016475	4016476
291,07 1	315,56 1	364,78 1	398,73 1	473,69 1	564,59 1
435	435	485	485	505	575
205	205	250	250	260	290

150	180	200	250	300	350
2700176	2700230	2700279	2700338	2700393	2700428
40,17 1	43,66 1	47,67 1	58,30 1	91,18 1	111,44 1
4014556	4016462	4014391	4014562	4013920	4012513
52,23 1	56,75 1	61,96 1	75,79 1	118,52 1	144,87 1

150	180	200	250	300	350
2700180	2700234	2700286	2700346	2700860	2700975
22,31 1	28,29 1	33,54 1	39,81 1	56,68 1	71,80 1
4016491	4016492	4016493	4016494	4016495	4016497
29,00 1	36,77 1	43,60 1	51,75 1	73,68 1	93,34 1

150	180	200	250	300	350
4008294	4008296	4008895	4011343	4007465	4007903
82,14 1	94,72 1	102,55 1	104,32 1	137,84 1	159,34 1

150	180	200	250	300	350
2700655	2700654	2700653	2700661	4007347	4014654
131,08 1	150,06 1	168,17 1	189,73 1	218,19 1	237,16 1
4014597	4014659	4014598	4014599	4014660	4014661
148,96 1	170,52 1	191,10 1	215,60 1	247,94 1	269,50 1

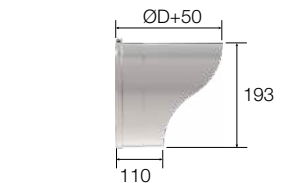
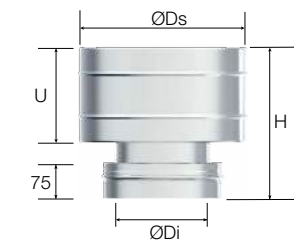

Lubricante silicona | Silicone lubricant | Graisse silicone



Ref.	5002932
€ U.	6,10 1

150	180	200	250	300	350
5003952	5003953	5003954	5003957	5003958	5003959
1,83 10	2,68 10	2,99 10	4,01 10	5,54 5	7,55 5
150	180	200	250	300	350
0,47	0,57	0,63	0,79	0,94	1,1

AISI 316L - 304	Referencia Reference Référence	4029300	68,92
Precio unidad € Unit price, € Prix unité €			

o	80	100	125
80	4029300	4029303	4029304
100	68,92	77,68	79,90
125	77,25	76,82	

o	80	100	125
80	4029368	4029369	4029370
100	137,30	149,88	150,77
125	140,25	142,92	154,19

Aumento · Reducción | Augmentation Adapter · Reduction Adapter | Augmentation · Réduction

Ø	80	100	125	130	150	180	200	250	300	350
80		4022715 126,27	4022718 137,83	4022723 138,66						
100	4022652 124,13		4022717 140,08	4022721 142,14	4022731 147,29					
125	4022669 128,98	4022677 131,44		4022720 140,41	4022727 141,80	4022739 146,04	4022743 164,47			
130	4022672 130,03	4022679 138,68	4022684 141,47		4022725 142,83	4022735 150,07	4022742 166,10			
150	4022675 131,00	4022682 140,34	4019995 142,24	4022690 142,24		4022733 156,41	4022741 170,41	4022746 185,79		
180			4022688 144,91	4022691 145,75	4022693 150,92		4022740 178,71	4022745 187,76		
200			4022689 147,84	4022692 148,34	4022695 151,83	4022698 161,61		4022744 189,78	4022749 203,76	
250					4022696 158,40	4012123 169,51	4022702 172,47		4022747 210,74	4022751 242,87
300					4014704 171,09	4022701 179,83	4022705 193,82	4022709 203,23		4022750 245,91
350							4022707 226,26	4022711 230,16	4022713 235,82	

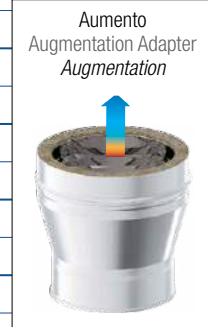

Unidad por embalaje: | Unit per package: | Unité par emballage: 1

ØDs mm	V = Longueur (mm) Réduction et l'élargissement conique efficace (15 °) à Simple paroi										
	80	100	125	130	150	180	200	250	300	350	
80		182	201	229							
100	182		145	192	201						
125	201	145		173	182	198	220				
130	229	192	173		145	170	192				
150	238	201	182	145		161	182	187			
180			198	170	161		166	171			
200			220	192	182	166		145	197		
250					187	171	145		192	230	
300					235	219	197			182	
350					272	256	235	230			

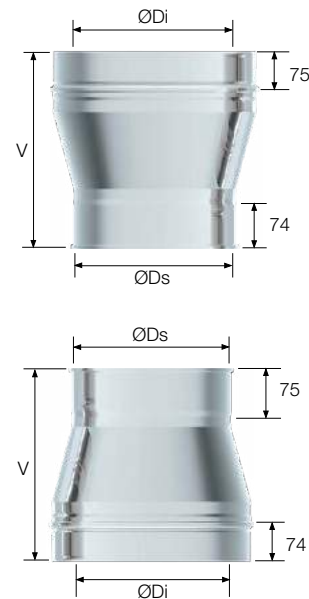

Aumento
Augmentation Adapter
Augmentation



Reducción
Reduction Adapter
Réduction



Aumento y Reducción excéntrica | Eccentric augmentation adapter and reduction adapter | Augmentation et réduction excentrées

o	80	100	125	130	150	180	200	250	300	350
80		4029368 137,30	4029369 149,88	4029370 150,77	4029948 152,16					
100	4029300 134,97		4029371 152,32	4029372 154,56	4029373 160,16					
125	4029303 140,25	4029304 142,92			4029378 154,19	4029379 158,80	4029380 178,84			
130	4029305 141,39	4029306 150,80			4029381 155,31	4029382 163,18	4029383 180,61			
150	4029340 142,44	4029341 152,60	4029342 154,67	4029343 154,67		4029384 170,07	4029385 185,30	4029386 202,03	4029949 215,20	
180			4029344 157,57	4029345 158,48	4029346 164,10		4029389 194,32	4029390 204,16	4029950 218,64	
200				4029348 161,30	4029349 165,10	4029355 175,73		4029391 206,36	4029393 221,57	4029951 235,41
250					4029356 172,24	4029357 184,32	4029358 187,54		4029394 229,15	4029396 264,10
300					4029359 186,04	4029361 195,54	4029362 210,75	4029363 220,99		4029397 267,40
350							4029364 246,03	4029365 250,28	4029366 256,42	

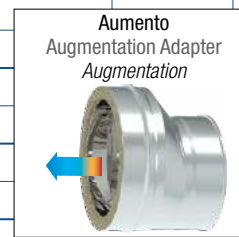
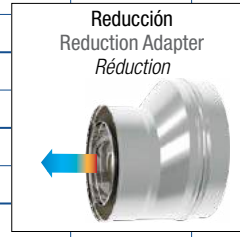

Unidad por embalaje: | Unit per package: | Unité par emballage: 1

ØDs mm	V = Longueur (mm) Réduction et l'élargissement conique efficace (15 °) à Simple paroi										
	80	100	125	130	150	180	200	250	300	350	
80		182	201	229	238						
100	182		145	192	201						
125	201	145			182	198	220				
130	229	192			145	170	192				
150	238	201	182	145		161	182	187	235		
180			198	170	161		166	171	219		
200				192	182	166		145	197	235	
250					187	171	145		192	230	
300					235	219	197	192		182	
350							235	230	182		

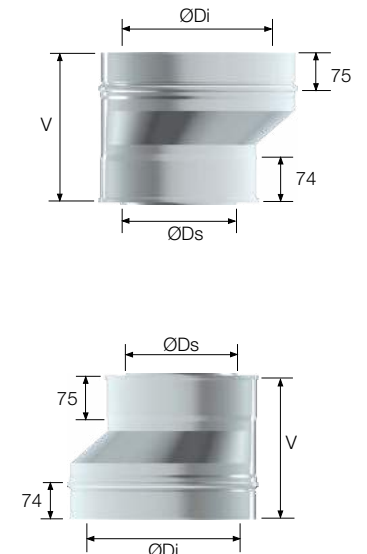

Aumento
Augmentation Adapter
Augmentation

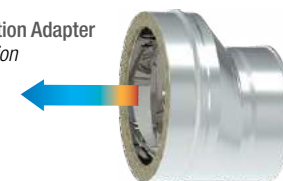

Reducción
Reduction Adapter
Réduction

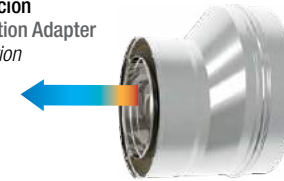

Abrazadera
Bracket
Bride, Collier

Soporte pared regulable | Adjustable wall support | Support mural réglable



ØDi mm		80	100	125	130	150
AISI 304	Ref.	4600725	4600721	4600722	4600722	4600723
	€ U.	69,83 1	74,86 1	78,80 1	78,80 1	86,68 1
Especificaciones técnicas Technical specifications Spécifications techniques						
A		183	203	232	232	252
B		240	260	290	290	310
ØDe mm		130	150	180	180	200

Abrazadera mural exterior | External wall bracket | Collier support mural extérieur



ØDi mm		80	100	125	130	150
AISI 304	Ref.	4019876	4019877	4019878	4019878	4019879
	€ U.	35,93 1	36,76 1	38,30 1	38,30 1	41,38 1

Prolongación mural (2 unidades) | Wall extension (2 units) | Rallonge murale (2 unités)

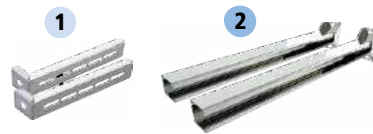

ØDi mm		150 mm	250 mm	500 mm	750 mm	1000 mm
AISI 304	Ref.	4019959	4019960	5004657	5004656	5004655
	€ U.	27,18 1	34,03 1	131,81 1	158,13 1	178,91 1

Abrazadera mural interior | Interior wall bracket | Bride murale intérieur



ØDi mm		80	100	125	130	150
AISI 304	Ref.	2500038	2500039	2500040	2500040	2500041
	€ U.	10,06 6	10,68 6	11,54 6	11,54 6	12,89 6
Especificaciones técnicas Technical specifications Spécifications techniques						
A		120	120	150	150	150

Abrazadera pared regulable | Adjustable wall bracket | Collier mural réglable



ØDi mm		80	100	125	130	150
AISI 304	Ref.	4600707	4600703	4600705	4600705	4600704
	€ U.	12,12 1	14,04 1	17,31 1	17,31 1	21,15 1
Especificaciones técnicas Technical specifications Spécifications techniques						
A		186	186	226	226	226

Abrazadera de unión clip | Pipe fast locking bracket | Collier de fixation à vis



ØDi mm		80	100	125	130	150
AISI 304	Ref.	5003962	5003976	5003977	5003977	5003978
	€ U.	4,88 1	5,34 1	5,48 1	5,48 1	5,57 1

Abrazadera de vientos | Roof brace band | Collier pour hauban



ØDi mm		80	100	125	130	150
AISI 304	Ref.	2700121	2700190	2700241	2700241	2700295
	€ U.	22,08 3	22,98 3	24,92 3	24,92 3	25,81 3

Abrazadera vientos estática | Static roof brace band | Bride de haubanage statique



ØDi mm		80	100	125	130	150
AISI 304	Ref.	4020129	4020130	4020131	4020131	4020132
	€ U.	43,83 1	45,63 1	48,18 1	48,18 1	50,02 1
Especificaciones técnicas Technical specifications Spécifications techniques						
L		250	250	250	250	250

Referencia Reference Référence	Ref.	4600723	Unidad de embalaje Packaging unit Unités par emballage
Precio unidad € Unit price, € Prix unité €	€ U.	74,86 1	

180	200	250	300	350
4600726	4600724	4600727	4600728	4600729
100,47 1	108,35 1	123,13 1	140,86 1	162,53 1

282	302	351	401	452
340	360	408	458	508
230	250	300	350	400

180	200	250	300	350
4019880	4019881	4019882	4020326	4020327
43,25 1	46,70 1	61,52 1	62,92 1	64,32 1

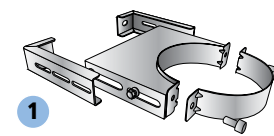

1
Para soporte mural interior y exterior (Ø130-Ø300)
For indoor and outdoor wall clamps (Ø130-Ø300)
Pour support mural intérieur et extérieur (Ø130-Ø300)

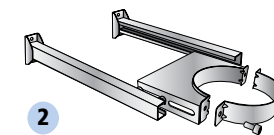

2
Para soporte mural interior (Ø350-Ø600) y exterior (Ø130-Ø600)
For indoor (Ø350-Ø600) and outdoor wall clamps (Ø130-Ø600)
Pour support mural intérieur (Ø350-Ø600) et extérieur (Ø130-Ø600)

180	200	250	300	350
5001351	2500042	2500043	2500510	2500044
17,52 2	18,69 2	24,04 2	32,91 2	46,55 2

190	190	230	230	300
-----	-----	-----	-----	-----

180	200	250	300	350
4600708	4600706	4600709	4600710	4600711
25,19 1	27,88 1	33,65 1	41,35 1	53,71 1

226	266	266	336	336
-----	-----	-----	-----	-----

180	200	250	300	350
5003988	5003979	5003981	5003982	5003983
5,72 1	5,79 1	7,68 1	8,43 1	9,27 1

180	200	250	300	350
2700214	2700354	2700403	2700323	2700418
29,66 1	30,46 1	38,86 1	52,95 1	60,52 1

180	200	250	300	350
4020133	4020134	4020135	4020136	4020137
54,41 1	56,33 1	61,27 1	75,34 1	83,95 1

250	250	250	250	333
-----	-----	-----	-----	-----

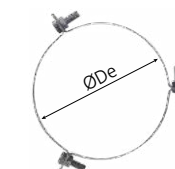
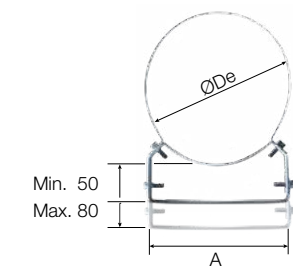
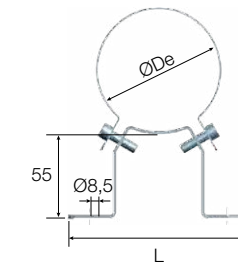
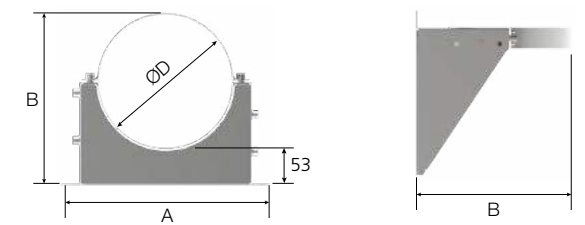

Abrazadera
Bracket
Bride, Collier

Escuadra soporte mural (2 unidades) | Square wall support (2 units) | Équerre support mural (2 unités)



	Pequeña* Small* Petite*	Mediana* Medium* Moyen*	Grande Large* Grand*
Ref.	4019925	4019926	4019927
€ U.	51,48 1	68,70 1	72,06 1
Espec. técnicas Technical specif. Spécif. techniques			
L	245	360	515
H	290	430	610

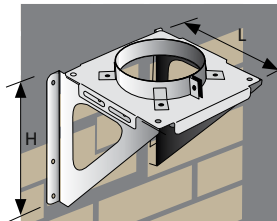

Escuadra con soporte mural
Square with wall support
Équerre avec support mural

* Consultar el tamaño adecuado en la página 165.
Refer to the appropriate size on page 165.
Voir la taille appropriée à la page 165

Escuadra reforzada (2 unidades) | Reinforced square (2 units) | Support renforcé (2 unités)



	L 500 mm	750 mm	1000 mm
Ref.	5003914	5003915	5003916
€ Kit	141,15 1	173,25 1	215,56 1
Espec. técnicas Technical specif. Spécif. techniques			
H	310	470	600

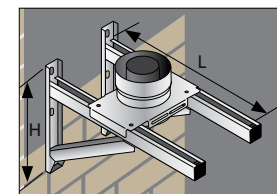

Escuadra reforzada con soporte mural
Reinforced square with wall support-
Support renforcé avec support mural

Abrazadera forjado | Ceiling bracket | Collier support plancher



	ØDi mm	80	100	125-130	150	180	200
AISI 304	Ref.	4022023	4022025	4022027	4011861	5001470	5001471
	€ U.	27,95 1	28,46 1	30,46 1	32,85 1	35,71 1	36,82 1
	ØDe mm	130	150	180	180	200	230

Abrazadera forjado reforzada | Reinforced ceiling bracket | Collier support plancher renforcé



	ØDi mm	80	100	125-130	150	180	200
AISI 304	Ref.	4026828	9023220	4026934	9023221	4026829	4023222
	€ U.	33,87 1	34,05 1	34,23 1	34,68 1	35,10 1	35,62 1
Especificaciones técnicas Technical specifications Spécifications techniques							
	A	103	103	103	103	103	103
	B	250	250	250	250	250	250

Soporte de montaje universal
Universal mounting support
Support fixation universel

1 Abrazadera forjado universal | Universal ceiling bracket | Collier support plancher universel



	ØDi mm	80	100	125-130	150	180	200
AISI 304	Ref.	4026043	4026044	4026045	4026046	4026047	4026048
	€ U.	29,93 1	30,08 1	30,14 1	30,86 1	31,28 1	32,11 1

2 Fijación forjado angular (2 unidades) | Angular forged fixation (2 units) | Fixation angulaire (2 unités)



	1000 mm
Ref.	4026057
€ U.	31,62 1

GALVANIZADA
GALVANIZED
GALVANISÉ

Referencia Reference Référence	Ref.	4026052	Unidad de embalaje Packaging unit Unités par emballage
Precio unidad € Unit price, € Prix unité €	€ U.	74,23 1	

Soporte mural universal | Universal wall support | Support mural universel



	ØDi mm	80	100	125-130	150	180	200	250	300	350
AISI 304	Ref.	4026049	4026050	4026051	4026052	4026053	4026054	4026059	4026060	4026061
	€ U.	58,60 1	62,78 1	68,36 1	74,23 1	80,92 1	86,98 1	106,37 1	123,23 1	138,23 1

Kit fijación reforzado universal (2 unidades) | Universal reinforced fastening kit (2 units) | Kit fixation renforcé universel (2 unités)



	1000 mm
Ref.	4026055
€ U.	45,54 1

Kit fijación soporte mural universal
Universal wall support kit
Kit support mural universel

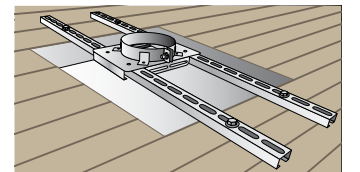

Soporte a techo regulable | Adjustable ceiling mounting | Support au toit réglable



	ØDi mm	130	150	180	200	250	300	350
Ref.	4013529	4012519	4013295	4012428	4015588	4015660	4014552	
	€ U.	67,33 1	67,76 1	68,79 1	69,35 1	71,27 1	71,63 1	72,45 1
Especificaciones técnicas Technical specifications Spécifications techniques								
	L	655	703	733	753	803	855	905

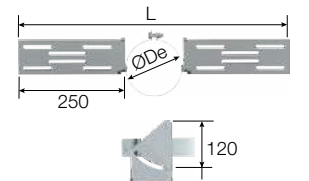

	250	300	350
Ref.	5001456	5001472	5001473
€ U.	52,02 1	53,98 1	56,62 1

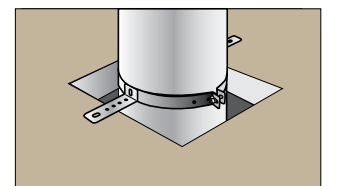
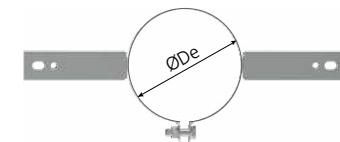
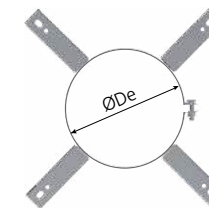

	250	300	350
Ref.	4023223	4023224	4023225
€ U.	38,84 1	39,83 1	41,27 1
	103	138	138
	250	300	300

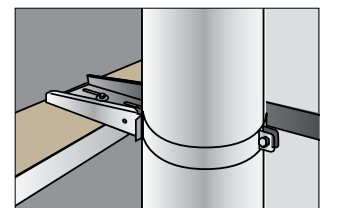
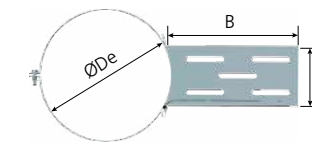

	250	300	350
Ref.	4026080	4026081	4026082
€ U.	36,21 1	44,68 1	51,43 1

3 Kit prolongación forjado | Forged extension kit | Kit extension étage



	ØDi mm	80 - 100 - 125/130 - 150	180 - 200
AISI 304	Ref.	4026038	4026042
	€ U.	52,67 1	73,73 1

GALVANIZADA
GALVANIZED
GALVANISÉ

1 2 3 Consultar las diferentes opciones de soporte en la página 165 | For support options, see page 165 | Pour les options d'assistance, voir page 165.

9 DPI

Doble Pared Industrial
Industrial Double Wall
Double Paroi Industriel

Ø400 - 650

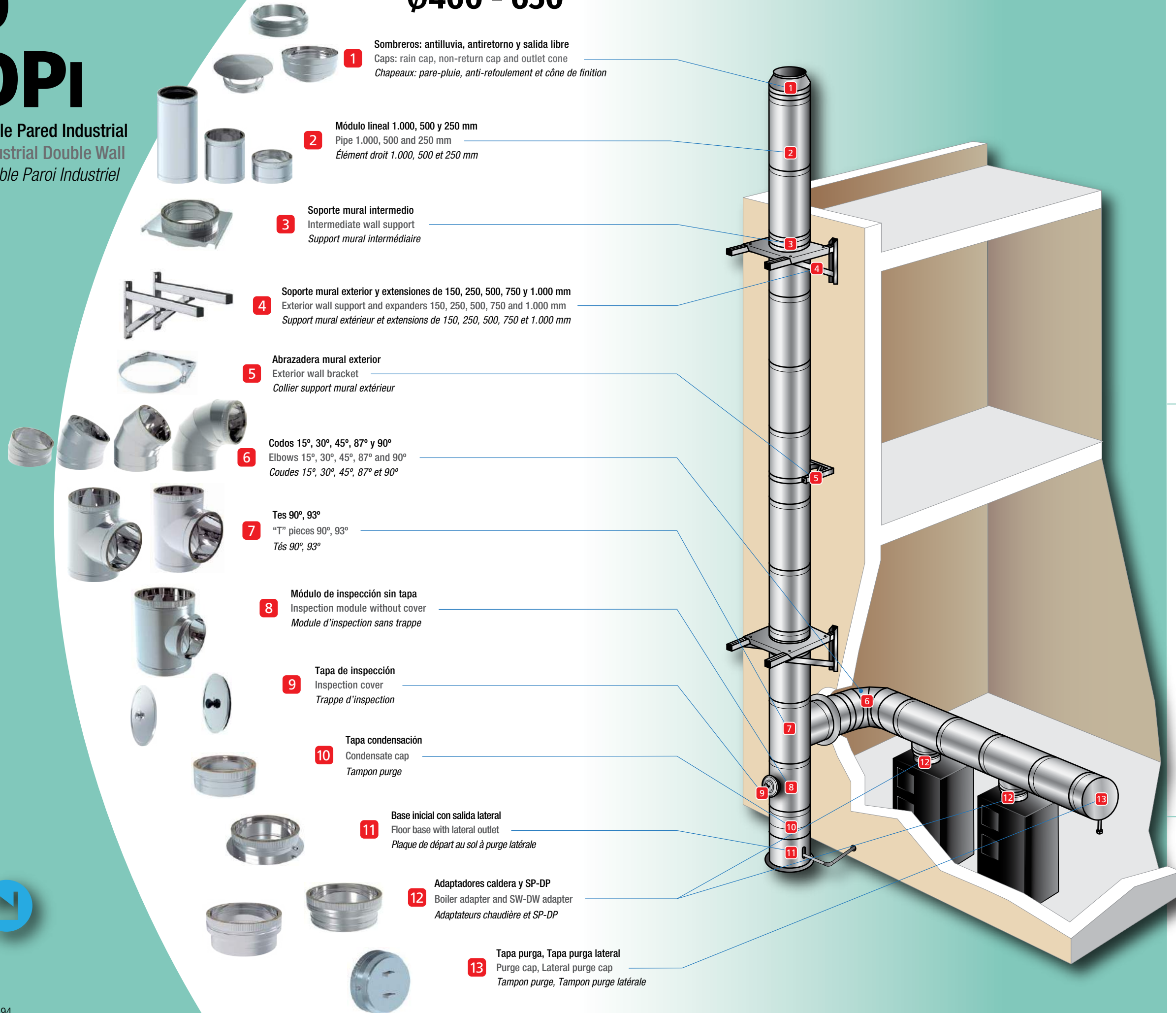

1 Sombreros: antilluvia, antiretorno y salida libre
Caps: rain cap, non-return cap and outlet cone
Chapeaux: pare-pluie, anti-refoulement et cône de finition

2 Módulo lineal 1.000, 500 y 250 mm
Pipe 1.000, 500 and 250 mm
Élément droit 1.000, 500 et 250 mm

3 Soporte mural intermedio
Intermediate wall support
Support mural intermédiaire

4 Soporte mural exterior y extensiones de 150, 250, 500, 750 y 1.000 mm
Exterior wall support and expanders 150, 250, 500, 750 and 1.000 mm
Support mural extérieur et extensions de 150, 250, 500, 750 et 1.000 mm

5 Abrazadera mural exterior
Exterior wall bracket
Collier support mural extérieur

6 Codos 15°, 30°, 45°, 87° y 90°
Elbows 15°, 30°, 45°, 87° and 90°
Coudes 15°, 30°, 45°, 87° et 90°

7 Tes 90°, 93°
"T" pieces 90°, 93°
Tés 90°, 93°

8 Módulo de inspección sin tapa
Inspection module without cover
Module d'inspection sans trappe

9 Tapa de inspección
Inspection cover
Trappe d'inspection

10 Tapa condensación
Condensate cap
Tampon purge

11 Base inicial con salida lateral
Floor base with lateral outlet
Plaque de départ au sol à purge latérale

12 Adaptadores caldera y SP-DP
Boiler adapter and SW-DW adapter
Adaptateurs chaudière et SP-DP

13 Tapa purga, Tapa purga lateral
Purge cap, Lateral purge cap
Tampon purge, Tampon purge latérale

CE Especificaciones de acuerdo a la legislación europea en productos de construcción CPR
Specifications according to EU product regulations of construction CPR
Spécifications Selon la réglementation européenne concernant les produits de construction CPR

Espesor del aislante
Insulation thickness
Épaisseur d'isolation 25 mm
Lana de roca
Rock wool
Laine de roche

interior y exterior | inside and outside | intérieur et extérieur

AISI 304
(1.4301) 2R

EN 1856-1

Ø400-650
T200 P1 W Vm L20050 O(15)*
T200 N1 W Vm L20050 O(15)
T450 N1 W Vm L20050 O(40)
T600 N1 W Vm L20050 O(45)
T600 N1 D Vm L20050 G(70)

interior | inside | intérieur

AISI 316L
(1.4404) 2R

exterior | outside | extérieur

AISI 304
(1.4301) 2R

EN 1856-1

Ø400-650
T200 P1 W Vm L50050 O(15)*
T200 N1 W Vm L50050 O(15)
T450 N1 W Vm L50050 O(40)
T600 N1 W Vm L50050 O(45)
T600 N1 D Vm L50050 G(70)

* Es necesario equipar estos elementos de una junta, consulte la página 101. Para saber el número de juntas, consulte la página 165.

* It's necessary to equip these elements with a joint, see page 101. For the number of joints, see page 165.

* Il est nécessaire d'équiper ces éléments d'un joint, voir page 101. Unités de joints par élément, voir page 165.

Para el resto de elementos, la junta es opcional.
For all other elements, the gasket is optional.
Pour tous les autres éléments, le joint est optionnel.

Módulo lineal y extensible
Linear and extendable module
Élément droit et télescopique

Módulo lineal | Linear module | Élément droit



ØDi mm 400 450 500 550 600 650

L 1000 mm

AISI	Ref.	4027339	4007145	4032136	4032137	4032138	4032139
304-304	€ U.	257,28	296,23	336,20	381,30	439,73	504,30
316L-304	Ref.	4029496	4029649	4029671	4029805	4030010	4030101
	€ U.	313,88	355,47	396,72	442,31	501,29	564,82

L 500mm

AISI	Ref.	4032126	4032128	4032132	4032133	4032134	4032135
304-304	€ U.	142,14	167,89	201,88	239,99	279,13	318,27
316L-304	Ref.	4029497	4029552	4029673	4029809	4030012	4030103
	€ U.	173,41	201,47	238,22	278,39	318,21	356,46

L 250 mm

AISI	Ref.	4032118	4032121	4032122	4032123	4032124	4032125
304-304	€ U.	106,09	130,81	162,74	192,61	219,39	255,44
316L-304	Ref.	4029498	4029551	4029672	4029808	4030011	4030102
	€ U.	129,43	156,97	192,03	223,43	250,10	286,09

ØDe mm 450 500 550 600 650 700

Módulo extensible | Extendable module | Élément télescopique



ØDi mm 400 450 500 550 600 650

Lmin 500 mm - Lmax 900 mm

AISI	Ref.	4032446	4032447	4032448	4032449	4032450	4032451
304-304	€ U.	332,69	376,98	420,24	461,44	496,46	540,75
316L-304	Ref.	4029472	4029535	4029658	4029768	4029979	4030078
	€ U.	405,88	452,38	495,88	535,27	565,96	605,64

Lmin 335 mm - Lmax 565 mm

AISI	Ref.	4032435	4032436	4032441	4032443	4032444	4032445
304-304	€ U.	231,75	271,92	311,06	346,08	380,07	424,36
316L-304	Ref.	4029471	4029534	4029657	4029766	4029978	4030077
	€ U.	282,74	326,30	367,05	401,45	433,28	475,28

Lmin 200 mm - Lmax 300 mm

AISI	Ref.	4032452	4032453	4032454	4032459	4032460	4032461
304-304	€ U.	210,12	245,14	284,28	323,42	356,38	390,37
316L-304	Ref.	4032462	4032463	4031694	4032464	4032465	4032466
	€ U.	256,35	294,17	335,45	375,17	406,27	437,21

Referencia Reference Référence	Ref.	4032136	Unidad de embalaje Packaging unit Unités par emballage
Precio unidad € Unit price, € Prix unité €	€ U.	336,20	1

Codo
Elbow
Coude

Codo | Elbow | Coude **15°**

ØDi mm 400 450 500 550 600 650

AISI	Ref.	4032574	4032568	4032569	4032571	4032572	4032573
304-304	€ U.	189,52	237,93	283,25	339,90	397,58	450,11
316L-304	Ref.	4029465	4029525	4029652	4029754	4029974	4030073
	€ U.	231,21	285,52	334,24	394,28	453,24	504,12

Especificaciones técnicas | Technical specifications | Spécifications techniques

	H	30	31	32	33	34	35
V	269	285	291	298	304	311	

ØDi 400 450 500 550 600 650

	H1	73	75	76	78	80	82
CDP 15° + CDP 15°	V1	555	568	581	594	607	620
	H2	132	135	138	142	145	148
	V2	580	594	607	619	632	644
CDP 15° + L(250) + CDP 15°	H1	125	127	128	130	132	133
	V1	748	761	774	787	800	813
	H2	184	187	190	194	197	200
CDP 15° + L(500) + CDP 15°	H1	189	191	193	195	196	198
	V1	990	1003	1016	1029	1042	1054
	H2	249	252	255	258	262	265
CDP 15° + L(1000) + CDP 15°	H1	319	321	322	324	326	327
	V1	1443	1466	1489	1512	1525	1537
	H2	378	381	384	388	391	394
V2	1499	1512	1525	1537	1550	1562	

CDP: Codo Doble Pared | Double Wall elbow | Coude Double Paroi

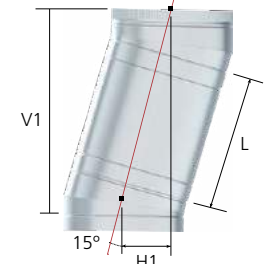
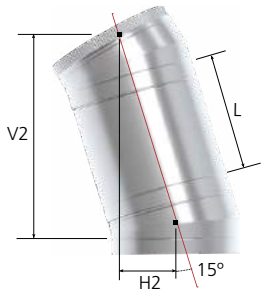

Codo | Elbow | Coude **30°**

ØDi mm 400 450 500 550 600 650

AISI	Ref.	4032575	4032558	4032559	4032560	4032566	4032567
304-304	€ U.	227,63	273,98	327,54	398,61	465,56	539,72
316L-304	Ref.	4029466	4029526	4029653	4029755	4029975	4030074
	€ U.	277,71	328,78	386,50	462,39	530,74	604,49

Especificaciones técnicas | Technical specifications | Spécifications techniques

	H	89	93	97	100	103	107
V	383	396	409	421	434	446	

ØDi 400 450 500 550 600 650

	H1	204	211	217	224	231	237
CDP 30° + CDP 30°	V1	761	786	811	836	861	886
	H2	361	373	385	398	410	423
	V2	671	693	715	736	758	780
CDP 30° + L(250) + CDP 30°	H1	305	311	317	324	331	337
	V1	935	960	985	1010	1035	1060
	H2	461	473	485	498	510	523
CDP 30° + L(500) + CDP 30°	H1	430	436	442	449	456	462
	V1	1151	1176	1201	1226	1251	1276
	H2	586	598	610	623	635	648
CDP 30° + L(1000) + CDP 30°	H1	680	686	692	699	706	712
	V1	1584	1609	1634	1659	1684	1709
	H2	836	848	860	873	885	898
V2	1495	1516	1537	1559	1581	1602	

CDP: Codo Doble Pared | Double Wall elbow | Coude Double Paroi

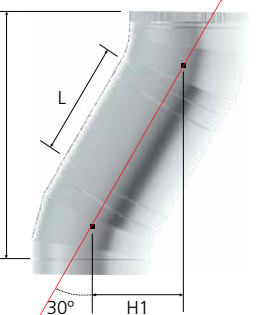
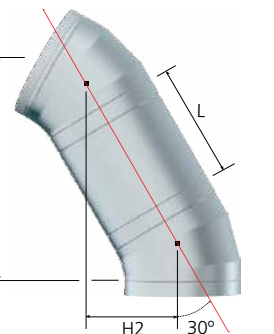
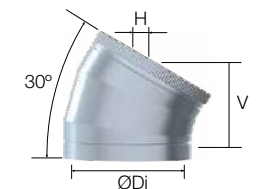

fabricado en: | made of: | fabriquée en: | **AISI 304 & AISI 316L 2R** (Brillante | Bright | Brillant)

Referencia Reference Référence	Ref.	4032554	Unidad de embalaje Packaging unit Unités par emballage
Precio unidad € Unit price, € Prix unité €	€ U.	362,56 1	

Codo
Elbow
Coude

Codo | Elbow | Coude 45°

ØDi mm	400	450	500	550	600	650
AISI 304-304	Ref. 2500154	4032552	4032554	4032555	4032556	4032557
€ U.	252,35 1	305,91 1	362,56 1	440,84 1	521,18 1	614,91 1
AISI 316L-304	Ref. 4029467	4029528	4029654	4029756	4029976	4030075
€ U.	307,87 1	367,09 1	427,82 1	511,37 1	594,15 1	688,70 1

ØDi mm	400	450	500	550	600	650
H	89	93	97	100	103	107
V	383	396	409	421	434	446

ØDi	400	450	500	550	600	650	
CDP 45° + CDP 45°	H1	340	354	368	383	398	412
	V1	819	854	889	925	960	995
	H2	553	578	603	628	653	678
	V2	605	630	655	680	705	730
CDP 45° + L(250) + CDP 45°	H1	480	495	510	524	539	554
	V1	959	995	1031	1066	1101	1137
	H2	694	719	744	769	794	819
	V2	746	771	796	821	846	871
CDP 45° + L(500) + CDP 45°	H1	657	672	687	701	716	730
	V1	1137	1172	1207	1243	1278	1314
	H2	871	896	921	946	971	996
	V2	923	948	973	998	1023	1048
CDP 45° + L(1000) + CDP 45°	H1	1010	1025	1040	1055	1069	1084
	V1	1491	1526	1561	1596	1632	1667
	H2	1225	1250	1275	1300	1325	1350
	V2	1276	1301	1326	1351	1376	1401

CDP: Codo Doble Pared | Double Wall elbow | Coude Double Paroi

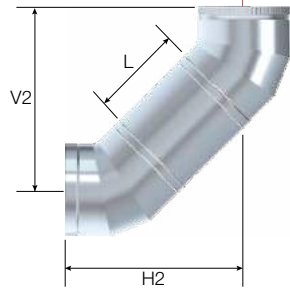
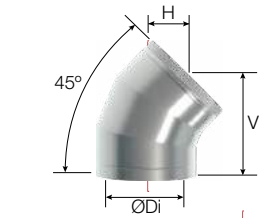

Codo | Elbow | Coude 87°

ØDi mm	400	450	500	550	600	650
AISI 316L-304	Ref. 4029469	4029530	4029656	4029765	4029977	4030076
€ U.	423,49 1	615,53 1	746,26 1	899,68 1	1.076,74 1	1.235,51 1

ØDi mm	400	450	500	550	600	650
H	482	507	532	557	582	607
V	426	451	475	498	522	546

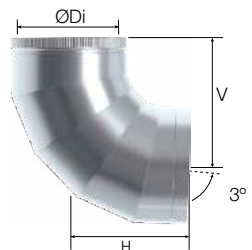

Codo | Elbow | Coude 90°

ØDi mm	400	450	500	550	600	650
AISI 304-304	Ref. 4025335	4032545	4032548	4032549	4032550	4032551
€ U.	347,12 1	512,94 1	632,42 1	775,59 1	944,51 1	1.103,13 1

ØDi mm	400	450	500	550	600	650
H	482	507	532	557	582	607
V	438	463	488	513	538	563

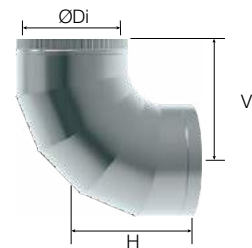

Adaptador
Adapter
Adaptateur

Adaptador SP - DP | SW - DW adapter | Adaptateur SP - DP



ØDi mm	400	450	500	550	600	650
AISI 304-304	Ref. 4027340	4029558	4029678	4029817	4030015	4030106
€ U.	124,39 1	138,02 1	158,62 1	197,76 1	236,90 1	272,95 1
AISI 316L-304	Ref. 4028927	4029616	4029705	4029865	4030044	4030134
€ U.	161,79 1	173,04 1	199,82 1	235,87 1	278,10 1	311,06 1

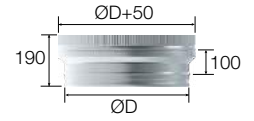

Te y Tapa
"T" Piece and Cover
Té et Tampon

Te sin tapa | "T" Piece without cover | Té sans tampon 90°



ØDi mm	400	450	500	550	600	650
AISI 304-304	Ref. 4029494	4029549	4029665	4029790	4030008	4030099
€ U.	437,75 1	548,99 1	671,56 1	769,41 1	888,89 1	1.035,15 1

Especificaciones técnicas | Technical specifications | Spécifications techniques

L	700	750	800	850	900	950
H	295	320	345	370	395	420
V	350	375	400	425	450	475

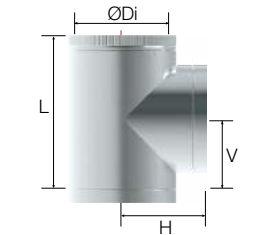

Te sin tapa | "T" Piece without cover | Té sans tampon 93°



ØDi mm	400	450	500	550	600	650
AISI 316L-304	Ref. 4029495	4029550	4029669	4029803	4030009	4030100
€ U.	534,06 1	658,79 1	792,44 1	892,52 1	1.013,33 1	1.159,37 1

Especificaciones técnicas | Technical specifications | Spécifications techniques

L	700	750	800	850	900	950
H	270	295	320	345	370	395
V	306	331	356	381	406	431

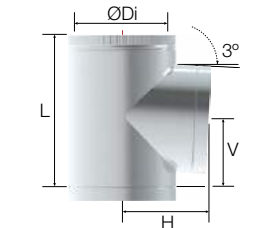

Te sin tapa | "T" Piece without cover | Té sans tampon 135°



ØDi mm	400	450	500	550	600	650
AISI 304-304	Ref. 4033751	4033753	4033754	4033755	4033756	4033757
€ U.	604,61 1	723,06 1	872,41 1	1.000,13 1	1.126,82 1	1.344,15 1
AISI 316L-304	Ref. 4033783	4033784	4033785	4033786	4033787	4033788
€ U.	737,62 1	867,67 1	1.029,44 1	1.160,15 1	1.284,57 1	1.505,45 1

Especificaciones técnicas | Technical specifications | Spécifications techniques

L	650	700	750	800	900	950
H	436	464	492	519	583	611
V	178	189	201	213	238	251



Tapa | Cap | Tampon



ØDi mm	400	450	500	550	600	650
AISI 316L-304	Ref. 4029491	4029540	4029666	4029784	4030005	4030091
€ U.	108,15 1	120,51 1	138,02 1	151,41 1	163,77 1	181,28 1

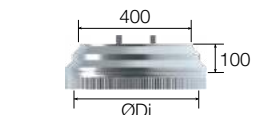

Tapa purga | Condensate cap | Tampon récupérateur condensats



ØDi mm	400	450	500	550	600	650
AISI 316L-304	Ref. 4029489	4029539	4029664	4029783	4030001	4030089
€ U.	134,93 1	147,29 1	166,86 1	182,31 1	196,73 1	221,45 1

Especificaciones técnicas | Technical specifications | Spécifications techniques

H	94	113	139	163	187	212
---	----	-----	-----	-----	-----	-----



Adaptador
Adapter
Adaptateur

Adaptador caldera | Boiler adapter | Adaptateur chaudière



ØDi mm	400	450	500	550	600	650
AISI 304-304	Ref. 2500067	4033051	4033052	4033054	4033055	4033056
€ U.	117,42 1	124,63 1	131,84 1	144,20 1	156,56 1	172,01 1
AISI 316L-304	Ref. 4029520	4029521	4029650	4029752	4029964	4030071
€ U.	143,25 1	149,56 1	155,57 1	167,27 1	178,48 1	192,65 1



Referencia Reference Référence	Ref.	4040311	Unidad de embalaje Packaging unit Unités par emballage
Precio unidad € Unit price, € Prix unité €	€ U.	216,92 1	

Tapa
Cover
Tampon

Tapa purga lateral | Lateral Condensate cap | Tampon récupérateur condensats latéral



ØDi mm		400	450	500	550	600	650
AISI 316L-304	Ref.	4040309	4040310	4040311	4040312	4040313	4040314
	€ U.	175,41 1	191,48 1	216,92 1	237,00 1	255,75 1	287,89 1
Especificaciones técnicas Technical specifications Spécifications techniques							
	H	133	158	184	208	232	257

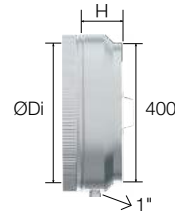

Módulo de inspección, purga, base y control de gases
Inspection, purge, base and gas control module
Module d'inspection, purge, base et contrôle du gaz

Módulo de inspección sin tapa | Inspection module without cap | Module inspection sans trappe



ØDi mm		400	450	500	550	600	650
AISI 304-304	Ref.	4040308	4040315	4040316	4040317	4040318	4040319
	€ U.	334,75 1	417,15 1	473,80 1	545,90 1	611,82 1	695,25 1
AISI 316L-304	Ref.	4029473	4029536	4029659	4029772	4029980	4030079
	€ U.	408,40 1	500,58 1	559,08 1	633,24 1	697,47 1	778,68 1



Codo inspección sin tapa | Inspection elbow without cap | Coude inspection sans trappe 87°



ØDi mm		400	450	500	550	600	650
AISI 316L-304	Ref.	4033088	4033091	4033092	4033093	4033094	4033095
	€ U.	481,91 1	590,68 1	659,72 1	747,23 1	823,02 1	918,84 1
Especificaciones técnicas Technical specifications Spécifications techniques							
	H	563	587	611	634	658	682
	V	624	649	674	699	724	749

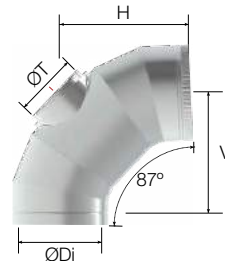

Tapa de inspección | Inspection cover | Trappe d'inspection

200°C / 200 Pa



Resistente a la humedad
Moisture resistant
Insensible à l'humidité

ØT mm	300
Ref.	5003272
€ U.	63,41 1

450°C / 40 Pa



Para combustibles sólidos
For solid fuels
Pour combustibles solides

ØT mm	300
Ref.	5003398
€ U.	88,77 1

Fijación al suelo
Floor fastening
Fixation au sol

Tapa condensación | Condensate cap | Tampon récupérateur condensats



ØDi mm		400	450	500	550	600	650
AISI 316L	Ref.	4029492	4029541	4029667	4029785	4030006	4030092
	€ U.	156,56 1	184,37 1	209,09 1	236,90 1	268,83 1	307,97 1

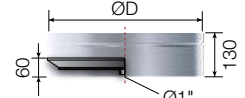

Tubo recortable | Cut-out piping | Élément recoupable

500 mm, 1.000 mm



1.000 mm



500 mm

ØDi mm		400	450	500	550	600	650
AISI 304	Ref.	4028614	4040400	4040401	4040402	4040403	4040404
	€ U.	138,38 1	166,32 1	201,72 1	239,48 1	279,42 1	333,02 1

ØDi mm		400	450	500	550	600	650
AISI 304	Ref.	4040405	4040406	4040407	4040408	4040409	4040410
	€ U.	83,86 1	100,80 1	122,25 1	145,14 1	169,34 1	201,83 1

Base inicial con salida lateral | Floor base with lateral outlet | Plaque de départ avec sortie latérale



ØDi mm		400	450	500	550	600	650
AISI 304	Ref.	4028612	4040412	4040413	4040414	4040415	4040416
	€ U.	65,23 1	79,06 1	95,89 1	113,84 1	132,82 1	158,30 1
ØDe mm		450	500	550	600	650	700

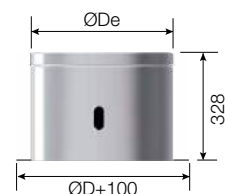

Módulos analizadores
Inspection modules
Modules d'inspection

Módulo analizador de gas | Gas inspection module | Module d'inspection de gaz



ØDi mm		400	450	500	550	600	650
AISI 316L-304	Ref.	4040324	4040331	4040332	4040333	4040334	4040335
	€ U.	152,73 1	185,23 1	226,60 1	263,64 1	295,12 1	337,59 1



Módulo analizador de gas y temperatura | Gas and temperature inspection module | Module d'inspection de gaz et température



ØDi mm		400	450	500	550	600	650
AISI 316L-304	Ref.	4040411	4040341	4040342	4040343	4040344	4040345
	€ U.	242,78 1	282,06 1	333,51 1	389,74 1	445,49 1	499,05 1



Pirómetro incluido
Pyrometer included
Pyromètre inclus
0-500°C



Soporte
Support
Support

Soporte mural intermedio | Intermediate wall support | Support mural intermédiaire



ØDi mm		400	450	500	550	600	650
AISI 304-304	Ref.	4040425	4040356	4040357	4040358	4040359	4040360
	€ U.	142,62 1	195,00 1	250,00 1	318,10 1	407,89 1	537,50 1
AISI 316L-304	Ref.	4029487	4029538	4029663	4029776	4030000	4030083
	€ U.	174,00 1	234,00 1	295,00 1	369,00 1	465,00 1	602,00 1
Especificaciones técnicas Technical specifications Spécifications techniques							
	A	435	485	535	585	635	685
	B	515	565	615	665	715	765

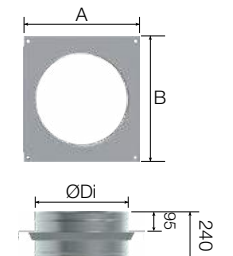

Sombrero
Cap
Chapeau

Sombrero antilluvia | Rain cap | Chapeau pare-pluie



ØDi mm		400	450	500	550	600	650
AISI 304-304	Ref.	4009184	4040361	4040002	4040362	4040363	4040364
	€ U.	218,66 1	251,67 1	301,69 1	366,38 1	435,96 1	514,29 1
AISI 316L-304	Ref.	4029483	4029537	4029660	4029773	4029981	4030080
	€ U.	266,77 1	311,06 1	366,68 1	437,75 1	511,91 1	593,28 1
Especificaciones técnicas Technical specifications Spécifications techniques							
	ØDs	700	750	800	850	900	950

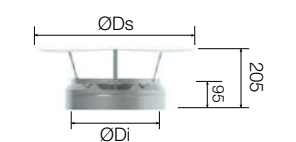

Sombrero antiretorno | Non-return cap | Chapeau anti-refoulement



ØDi mm		400	450	500	550	600	650
AISI 304-304	Ref.	4040423	4040365	4040366	4040367	4040368	4040369
	€ U.	306,13 1	352,33 1	422,37 1	512,93 1	610,35 1	720,00 1
AISI 316L-304	Ref.	4040424	4040370	4040371	4040372	4040373	4040374
	€ U.	373,48 1	422,80 1	498,40 1	595,00 1	695,80 1	806,40 1
Especificaciones técnicas Technical specifications Spécifications techniques							
	Dp	600	650	700	750	800	850
	Dd	500	550	600	650	700	750

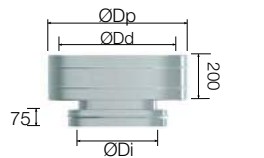

Sombrero salida libre | Outlet cone | Cône de finition



ØDi mm		400	450	500	550	600	650
AISI 304-304	Ref.	4012752	4040375	4040376	4040377	4040378	4040379
	€ U.	151,97 1	199,17 1	241,53 1	297,41 1	351,75 1	409,82 1
AISI 316L-304	Ref.	4029485	4012663	4029662	4029775	4029983	4030082
	€ U.	185,40 1	246,17 1	293,55 1	355,35 1	413,03 1	472,77 1

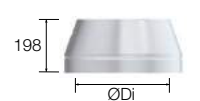

Abrazadera mural exterior | External wall bracket | Collier support mural extérieur

		ØDi mm					
		400	450	500	550	600	650
AISI 304	Ref.	4031696	4031697	4031698	4031699	4031700	4031701
	€ U.	136,99	159,92	182,57	204,23	233,81	266,77
Especificaciones técnicas Technical specifications Spécifications techniques							
	A	503	553	603	653	703	753
	B	276	301	326	351	376	401
		ØDe mm					
		450	500	550	600	650	700

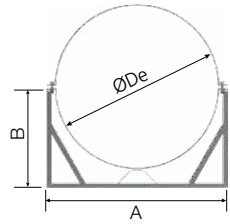

Abrazadera mural interior | Interior wall bracket | Bride murale intérieure

		ØDi mm					
		400	450	500	550	600	650
AISI 304	Ref.	4035019	4035066	4035067	4035068	4035069	4035070
	€ U.	61,43	71,07	81,86	91,57	104,84	119,62
Especificaciones técnicas Technical specifications Spécifications techniques							
	A	405	505	605	405	505	605

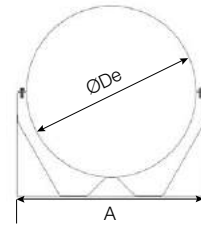

Abrazadera de vientos | Roof brace band | Collier pour hauban

		ØDi mm					
		400	450	500	550	600	650
AISI 304	Ref.	4014608	4014609	4014610	4014611	4014612	4014613
	€ U.	65,71	69,42	72,34	75,65	78,69	80,85

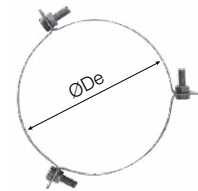

Abrazadera unión ancha | Wide connection bracket | Collier de fixation large

		ØDi mm					
		400	450	500	550	600	650
AISI 304	Ref.	5005567	5005568	5005569	5005570	5005571	5005572
	€ U.	15,08	16,68	18,05	19,28	20,81	22,38

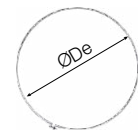

Abrazadera forjado universal | Universal ceiling bracket | Collier support plancher universel

		ØDi mm					
		400	450	500	550	600	650
AISI 304	Ref.	4040131	4040132	4040133	4040134	4040215	4040216
	€ U.	58,65	61,47	64,84	68,28	70,79	75,85

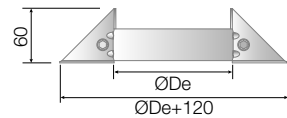

Abrazadera forjado reforzada | Reinforced ceiling bracket | Collier support plancher renforcé

		ØDi mm					
		400	450	500	550	600	650
AISI 304	Ref.	4023226	4026831	4026832	4026833	4026834	4026835
	€ U.	44,29	45,66	48,65	54,14	57,11	60,67
Especificaciones técnicas Technical specifications Spécifications techniques							
	A	138	173	173	173	173	173
	B	300	350	350	350	350	350

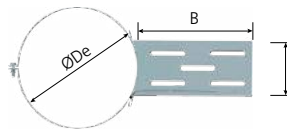

Soporte a techo regulable | Adjustable roof support | Support au toit réglable

		ØDi mm					
		400	450	500	550	600	650
AISI 304	Ref.	4040054	4040055	4040056	4040057	4040058	4040059
	€ U.	97,85	100,94	104,03	107,13	110,21	113,30
Especificaciones técnicas Technical specifications Spécifications techniques							
	L	955	1005	1055	1105	1155	1205

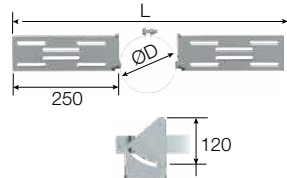

Referencia Reference Référence	Ref.	4031698	Unidad de embalaje Packaging unit Unités par emballage
Precio unidad € Unit price, € Prix unité €	€ U.	182,57	1

Soporte mural universal | Universal wall support | Support mural universel

		ØDi mm					
		400	450	500	550	600	650
AISI 304	Ref.	4026062	4026063	4026064	4026066	4026067	4026069
	€ U.	176,62	209,61	243,60	271,92	303,64	339,90
Especificaciones técnicas Technical specifications Spécifications techniques							
	A	485	535	585	635	685	735
	B	565	615	665	715	765	815

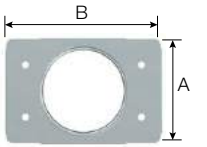

Escuadra reforzada (2 unidades) | Reinforced square (2 units) | Support renforcé (2 unités)

		L		
		500 mm	750 mm	1000 mm
Ref.		5003914	5003915	5003916
€ U.		141,15	173,25	215,56
Especific. técnicas Technical specific. Spécific. techniques				
	H	310	470	600

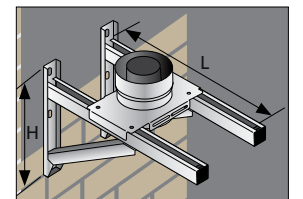

Escuadra reforzada con soporte mural
Reinforced square with wall support
Support renforcé avec support mural

Abrazadera forjado | Ceiling bracket | Collier support plancher

		ØDi mm					
		400	450	500	550	600	650
AISI 304	Ref.	5001475	5001476	5001477	5001478	5001479	5001480
	€ U.	69,62	72,30	74,31	77,50	81,16	83,73

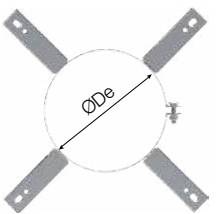

Fijación forjado angular (2 unidades) | Angular forged fixation (2 units) | Fixation angulaire (2 unités)

		1000 mm	
Ref.		4026057	
€ U.		31,62	1

Kit fijación reforzado universal (2 unidades) | Universal reinforced kit (2 units) | Kit fixation renforcé universel (2 unités)

		1000 mm	
Ref.		4026055	
€ U.		45,54	1

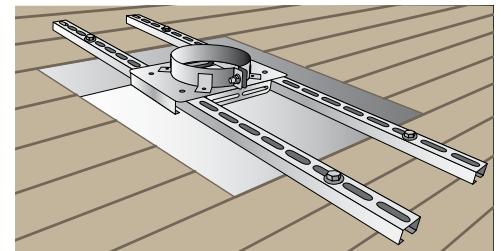

Kit fijación soporte mural universal
Universal wall support fastening kit
Kit de fixation universelle support mural

Junta silicona | Silicone gasket | Joint silicone

		ØDi mm					
		400	450	500	550	600	650
Ref.		5003960	5005716	5005717	5005718	5005719	5005720
€ U.		9,48	11,85	14,21	16,48	19,06	21,35



10 DPC

Doble Pared colectivo
Collective Double Wall
Double Paroi collectif

Ø80 - 250



Núm. 14.2/15-2103_V1

CE Especificaciones de acuerdo a la legislación europea en productos de construcción CPR
Specifications according to EU product regulations of construction CPR
Spécifications Selon la réglementation européenne concernant les produits de construction CPR

Espeador del aislante
Insulation thickness
Épaisseur d'isolation 25 mm
Lana de roca
Rock wool
Laine de roche

interior | inside | intérieur

AISI 316L

(1.4404) 2R

exterior | outside | extérieur

AISI 304

(1.4301) 2R

EN 1856-1

Ø80-250 T200 P1 W V2 L50040 O(15)*

T200 N1 W V2 L50040 O(15)

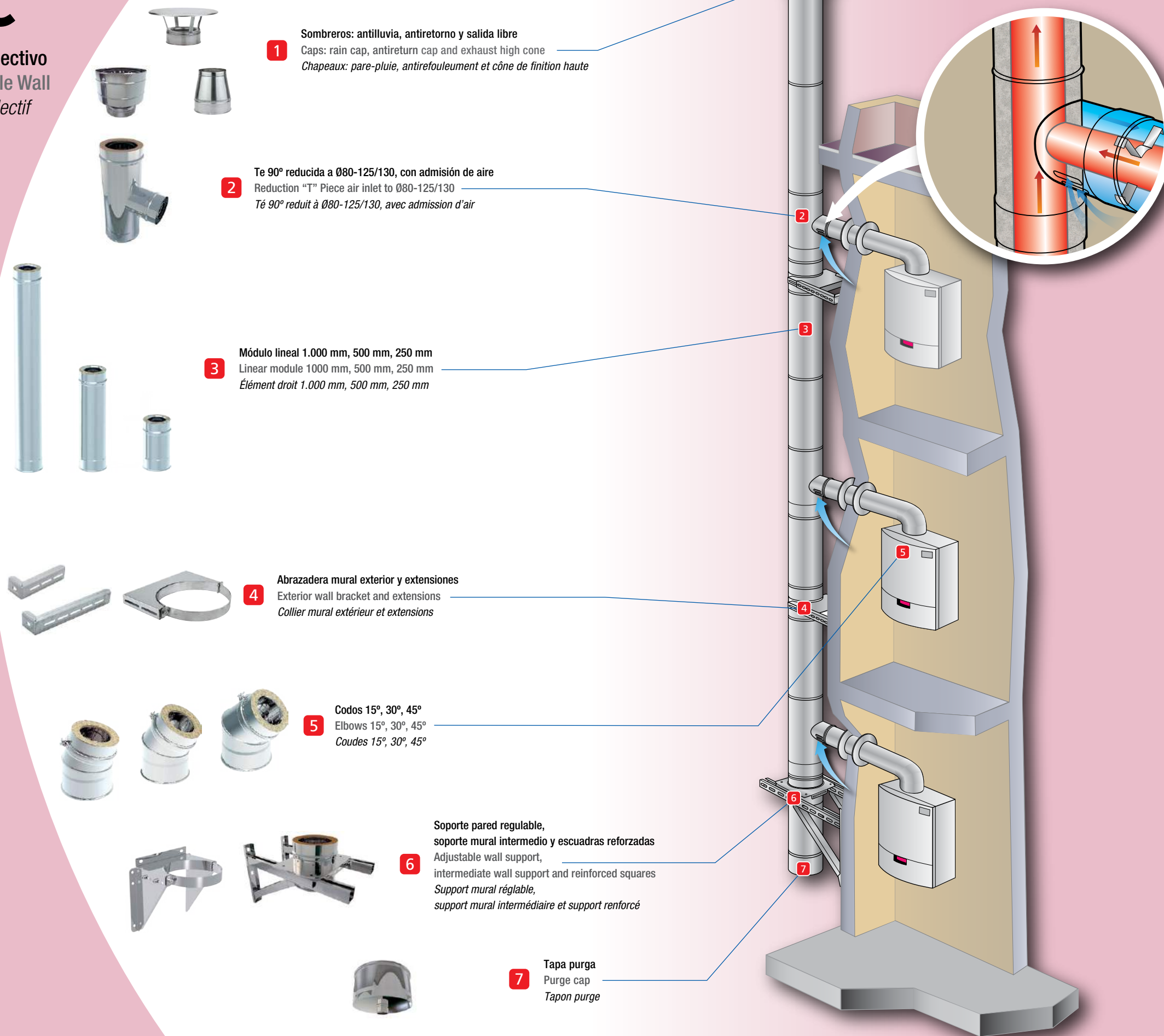

1 Sombreros: antilluvia, antiretorno y salida libre
Caps: rain cap, antireturn cap and exhaust high cone
Chapeaux: pare-pluie, antirefoulement et cône de finition haute

2 Te 90° reducida a Ø80-125/130, con admisión de aire
Reduction "T" Piece air inlet to Ø80-125/130
Té 90° réduit à Ø80-125/130, avec admission d'air

3 Módulo lineal 1.000 mm, 500 mm, 250 mm
Linear module 1000 mm, 500 mm, 250 mm
Élément droit 1.000 mm, 500 mm, 250 mm

4 Abrazadera mural exterior y extensiones
Exterior wall bracket and extensions
Collier mural extérieur et extensions

5 Codos 15°, 30°, 45°
Elbows 15°, 30°, 45°
Coudes 15°, 30°, 45°

6 Soporte pared regulable, soporte mural intermedio y escuadras reforzadas
Adjustable wall support, intermediate wall support and reinforced squares
Support mural réglable, support mural intermédiaire et support renforcé

7 Tapa purga
Purge cap
Tapon purge

* Para cumplir con esta designación todos los elementos deben estar instalados con juntas, consulte la página 108. Para saber el número de juntas, consulte la página 165.

* To comply with this designation, all elements must be installed with gaskets, see page 108. For the number of joints, see page 165.

* Pour respecter cette désignation, tous les éléments doivent être installés avec des joints, voir page 108. Unités de joints par élément, voir page 165.

Para el resto de elementos, la junta es opcional.
For all other elements, the gasket is optional.
Pour tous les autres éléments, le joint est optionnel.

fabricado en: made of: fabriquée en: **AISI 316L & AISI 304 2R** (Brillante | Bright | Brillant)

Módulo lineal y extensible
Linear and extendable module
Élément droit et télescopique

Módulo lineal | Linear module | Élément droit



ØDi mm	130	150	180	200	250	300
L 1.000 mm						
AISI Ref.	4016251	4014573	4015912	4009371	4014574	4009452
316L-304 € U.	94,43	102,85	119,71	130,23	182,68	238,42
L 500 mm						
AISI Ref.	4015051	4014488	4016257	4014489	4011636	4014742
316L-304 € U.	59,06	63,47	70,84	76,20	100,03	125,35
L 250 mm						
AISI Ref.	4016262	4014490	4016263	4014491	4011774	4016264
316L-304 € U.	43,39	44,47	52,04	56,35	81,90	86,77
ØDe mm	180	200	230	250	300	350

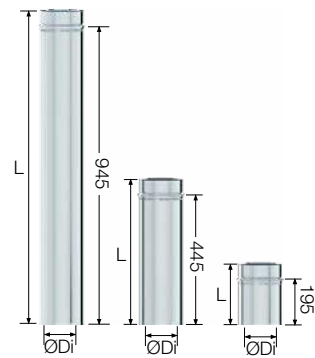

Módulo extensible | Extendable module | Élément télescopique



ØDi mm	130	150	180	200	250	300
Lmin 500 mm - Lmax 900 mm						
AISI Ref.	4016669	4008377	4016670	4014500	4011772	4014743
316L-304 € U.	141,05	146,60	170,66	189,12	276,97	305,34
Lmin 335 mm - Lmax 565 mm						
AISI Ref.	4015052	4014495	4016666	4014365	4011773	4012406
316L-304 € U.	104,76	111,22	120,15	135,54	165,87	210,25
Lmin 200 mm - Lmax 300 mm						
AISI Ref.	4016661	4014496	4016662	4014497	4014499	4016663
316L-304 € U.	70,51	78,18	89,23	121,49	130,46	162,02



Codo
Elbow
Coude

Codo | Elbow | Coude 15°



ØDi mm	130	150	180	200	250	300
AISI Ref.	4016573	4016574	4016575	4016576	4016577	4016578
316L-304 € U.	54,00	59,95	71,54	76,92	91,27	141,01
Especificaciones técnicas Technical specifications Spécifications techniques						
H	11	11	11	12	13	13
V	123	126	130	132	139	139



Codo | Elbow | Coude 30°



ØDi mm	130	150	180	200	250	300
AISI Ref.	4016582	4014553	4016583	4014576	4011638	4009453
316L-304 € U.	58,75	65,20	77,82	83,67	99,26	153,38
Especificaciones técnicas Technical specifications Spécifications techniques						
H	25	26	28	29	33	36
V	136	141	148	153	166	178

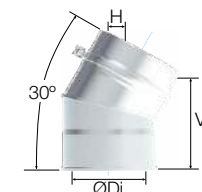

Codo | Elbow | Coude 45°



ØDi mm	130	150	180	200	250	300
AISI Ref.	4015053	4008379	4016588	4012119	4011639	4012423
316L-304 € U.	62,05	69,01	87,76	94,76	117,15	174,18
Especificaciones técnicas Technical specifications Spécifications techniques						
H	42	43	47	50	57	63
V	145	151	161	167	185	202

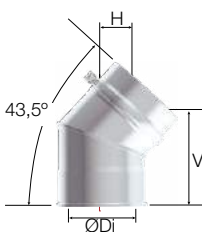

Referencia Reference Référence	Ref.	4014573	Unidad de embalaje Packaging unit Unités par emballage
Precio unidad € Unit price, € Prix unité €	€ U.	102,85	1

Te y tapa
"T" Piece and cover
Té et tampon

Te reducida con admisión de aire a | Reduction "T" Piece air inlet to | Té réduit avec prise d'air à 60 / 100 mm



ØDi mm	130	150	180	200	250	300
AISI Ref.	4022106	4022107	4022108	4015866	4019371	4022110
316L-304 € U.	130,81	133,33	139,92	142,53	170,48	187,50

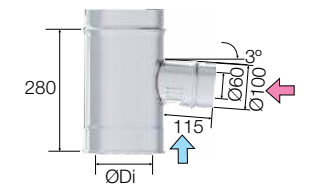

Te reducida con admisión de aire a | Reduction "T" Piece air inlet to | Té réduit avec prise d'air à 80 / 125 mm



ØDi mm	130	150	180	200	250	300
AISI Ref.	9022112	4022113	4022114	4022115	4022116	4022117
316L-304 € U.	126,56	127,80	135,59	137,93	176,60	204,13

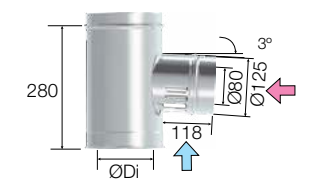
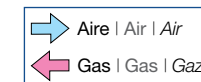

Conducto de conexión + tapa | Connecting piping + cap | Conduit de liaison + tampon RAL 9016



ØDi / ØDe mm	80/125
Ref.	4025843
€ U.	68,65

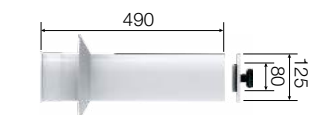

Te 90° reducida a | 90° "T" Piece reduced to | Té 90° réduit à 80 mm



ØDi mm	130	150	180	200	250	300
AISI Ref.	4017419	4017420	4017581	4017582	4017583	4013921
316L-304 € U.	145,83	162,20	182,74	201,80	228,65	252,01

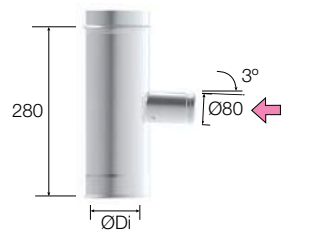

Tapa purga | Condensate cap | Tampon récupérateur condensats



ØDi mm	130	150	180	200	250	300
AISI Ref.	4015943	4015952	4015944	4015867	4015945	4013919
316L-304 € U.	30,52	32,70	38,18	39,99	51,87	66,52
Especificaciones técnicas Technical specifications Spécifications techniques						
ØG	1/2"	1/2"	1/2"	1/2"	3/4"	3/4"



Soporte
Support
Support

Soporte mural intermedio | Intermediate wall support | Support mural intermédiaire



ØDi mm	130	150	180	200	250	300
AISI Ref.	4020109	4020110	4020111	4020112	4020113	4020114
316L-304 € U.	64,49	70,83	77,56	82,44	93,88	108,76
Especificaciones técnicas Technical specifications Spécifications techniques						
A	165	185	215	235	283	333
B	245	265	295	315	363	413

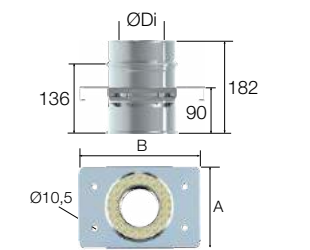

fabricado en: | made of: | fabriquée en: **AISI 316L & AISI 304 2R** (Brillante | Bright | Brillant)

Sombrero
Cap
Chapeau

Sombrero antilluvia | Rain cap | Chapeau pare-pluie



ØDi mm		130	150	180	200	250	300
AISI 316L-304	Ref.	4016436	4008380	4015399	4012122	4014558	4016437
	€ U.	58,75	59,62	76,31	81,26	98,07	168,87

Especificaciones técnicas Technical specifications Spécifications techniques		V	143	143	143	143	143	180
	ØDs	250	250	300	300	400	400	500

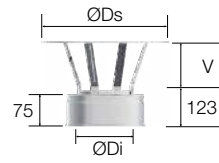

Sombrero antiretorno | Non-return cap | Chapeau anti-refoulement



ØDi mm		130	150	180	200	250	300
AISI 316L-304	Ref.	4016449	4014559	4016450	4014560	4014561	4016451
	€ U.	93,91	106,14	119,78	129,54	164,29	186,64

Especificaciones técnicas Technical specifications Spécifications techniques		V	265	265	265	265	323	323
	ØDs	180	200	230	250	350	400	400
	U	142	142	142	142	200	200	200

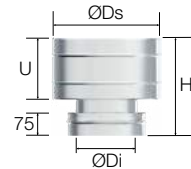

Sombrero salida libre | Exhaust high cone | Cône de finition haute



ØDi mm		130	150	180	200	250	300
AISI 316L-304	Ref.	4016461	4014556	4016462	4014391	4014562	4013920
	€ U.	50,14	52,23	56,75	61,96	75,79	118,52

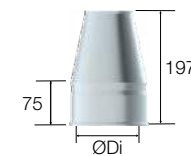

Terminal sencillo | Outlet cone | Cône de finition



ØDi mm		130	150	180	200	250	300
AISI 316L-304	Ref.	4016490	4016491	4016492	4016493	4016494	4016495
	€ U.	27,41	29,00	36,77	43,60	51,75	73,68



Junta
Gasket
Joint

Junta silicona | Silicone gasket | Joint silicone



ØDi mm		130	150	180	200	250	300
	Ref.	5003951	5003952	5003953	5003954	5003957	5003958
	€ U.	1,38	1,83	2,68	2,99	4,01	5,54

Abrazadera
Bracket
Bride, Collier

Soporte pared regulable | Adjustable wall support | Support mural réglable



ØDi mm		130	150	180	200	250	300
AISI 304	Ref.	4600722	4600723	4600726	4600724	4600727	4600728
	€ U.	78,80	86,68	100,47	108,35	123,13	140,86

Especificaciones técnicas Technical specifications Spécifications techniques		A	232	252	282	302	351	401
	B	290	310	340	360	408	458	458

ØDe mm		180	200	230	250	300	350
--------	--	-----	-----	-----	-----	-----	-----

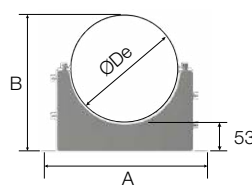

Abrazadera mural exterior | External wall bracket | Collier support mural extérieur



ØDi mm		130	150	180	200	250	300
AISI 304	Ref.	4019878	4019879	4019880	4019881	4019882	4020326
	€ U.	38,30	41,38	43,25	46,70	61,52	62,92

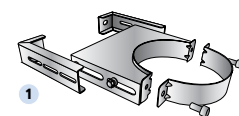

Prolongación mural (2 unidades) | Wall extension (2 units) | Rallonge murale (2 unités)

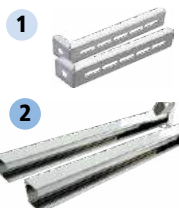

L		150 mm	250 mm	500 mm	750 mm	1000 mm
AISI 304	Ref.	4019959	4019960	5004657	5004656	5004655
	€ U.	27,18	34,03	131,81	158,13	178,91

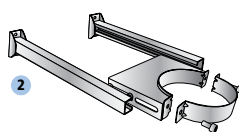

Referencia Reference Référence	Ref.	4008380	Unidad de embalaje Packaging unit Unités par emballage
Precio unidad € Unit price, € Prix unité €	€ U.	59,62	1

Abrazadera
Bracket
Bride, Collier

Abrazadera de vientos | Roof brace band | Collier pour hauban



ØDi mm		130	150	180	200	250	300
AISI 304	Ref.	2700241	2700295	2700214	2700354	2700403	2700323
	€ U.	24,92	25,81	29,66	30,46	38,86	52,95



Abrazadera de unión clip | Clip-on connection bracket | Clip de fixation



ØDi mm		130	150	180	200	250	300
AISI 304	Ref.	5003977	5003978	5003988	5003979	5003981	5003982
	€ U.	5,48	5,57	5,72	5,79	7,68	8,43

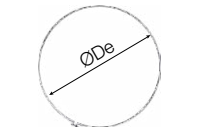

Abrazadera vientos estática | Static roof brace band | Bride de haubanage statique



ØDi mm		130	150	180	200	250	300
AISI 304	Ref.	4020131	4020132	4020133	4020134	4020135	4020136
	€ U.	48,18	50,02	54,41	56,33	61,27	75,34



Escuadra soporte mural (2 unidades) | Square wall support (2 units) | Équerre support mural (2 unités)



	Pequeño* Small* Petit*	Mediano* Medium* Moyen*	Grande* Large* Grand*
Ref.	4019925	4019926	4019927
€ Kit	51,48	68,70	72,06
L	245	360	515
H	290	430	610

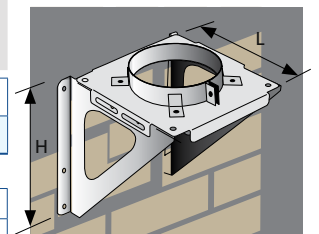

Escuadra con soporte mural
Square with wall support
Équerre avec support mural

* Consultar el tamaño adecuado en la página 165.
Refer to the appropriate size on page 165.
Voir la taille appropriée à la page 165.

Soporte mural universal | Universal wall support | Support mural universel



ØDi mm		130	150	180	200	250	300
AISI 304	Ref.	4026051	4026052	4026053	4026054	4026059	4026060
	€ U.	68,36	74,23	80,92	86,98	106,37	123,23

Escuadra reforzada (2 unidades) | Reinforced square (2 units) | Support renforcé (2 unités)



L	500 mm	750 mm	1000 mm
Ref.	5003914	5003915	5003916
€ U.	141,15	173,25	215,56
H	310	470	600

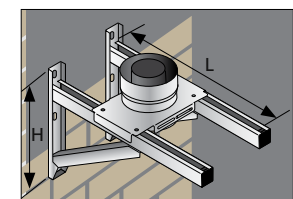

Escuadra reforzada con soporte mural
Reinforced square with wall support
Support renforcé avec support mural

Abrazadera forjado reforzada | Reinforced ceiling bracket | Collier support plancher renforcé



ØDi mm		130	150	180	200	250	300
AISI 304	Ref.	4026934	9023221	4026829	4023222	4023223	4023224
	€ U.	34,23	34,68	35,10	35,62	38,84	39,83
	A			103			138
	B			250			300

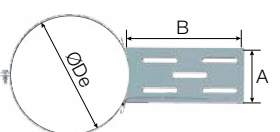

11 DPEI

Doble Pared 50 mm
50 mm Double Wall
Double Paroi 50 mm

Ø130 - 600



CE Especificaciones de acuerdo a la legislación europea en productos de construcción CPR
Specifications according to EU product regulations of construction CPR
Spécifications Selon la réglementation européenne concernant les produits de construction CPR

CLASIFICACIÓN CLASSIFICATION CLASSEMENT

EI30 (UNE-EN 13501-3: 2010)

EI 30 (ve i ↔ o)

Ensayo nº I Test num. I Essai num. 17/15180-1958

EI 30 (ho i ↔ o)

Ensayo nº I Test num. I Essai num. 17/13563-1342

EI60 (UNE-EN 13501-3: 2010)

EI 60 (ve i ↔ o)

Ensayo nº I Test num. I Essai num. 17/15180-1958

EI 60 (ho i ↔ o)

Ensayo nº I Test num. I Essai num. 17/13563-1342

Esesor del aislante
Insulation thickness
Épaisseur d'isolation 50 mm
Lana de roca
Rock wool
Laine de roche

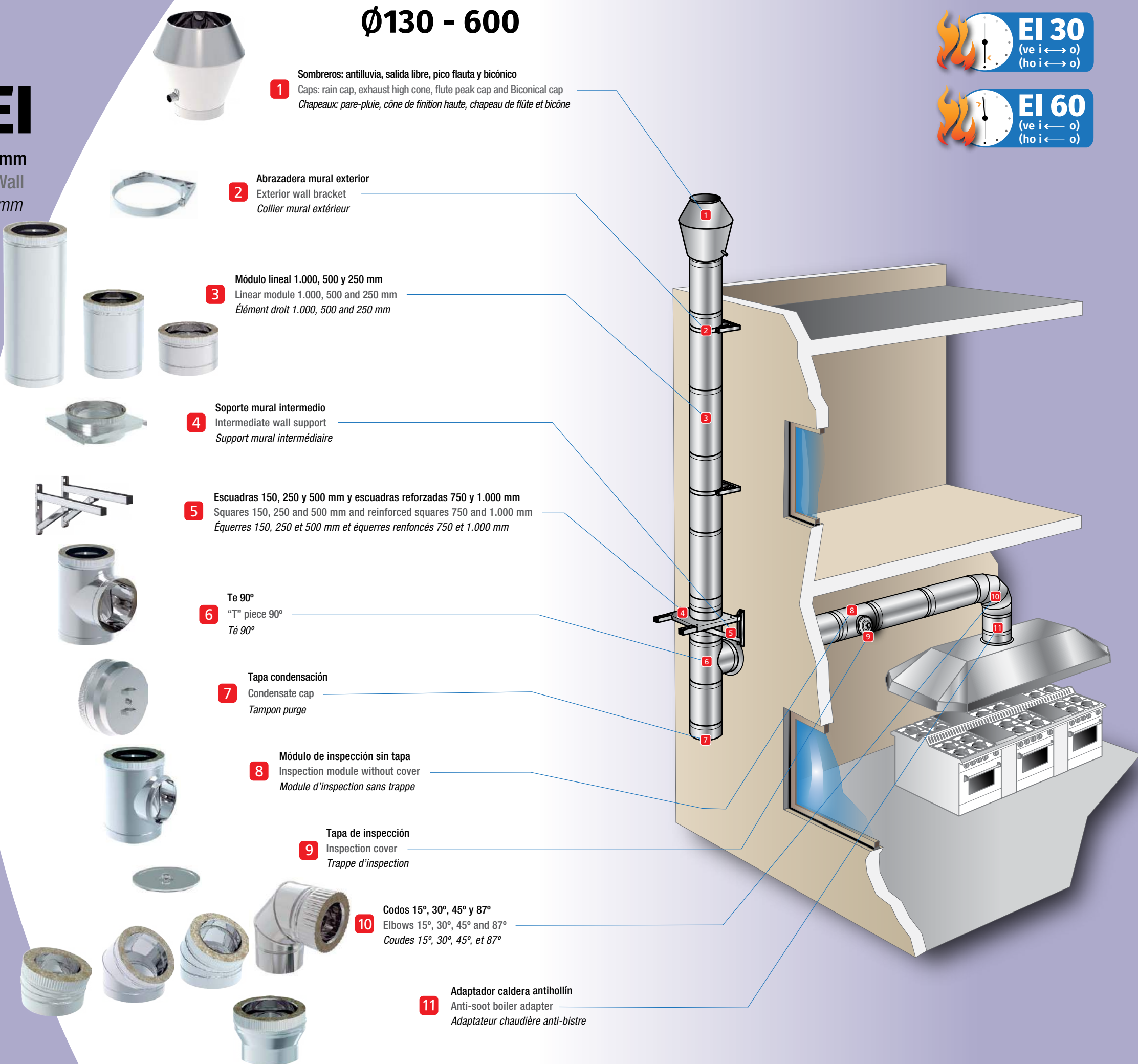

1 Sombreros: antilluvia, salida libre, pico flauta y bicónico
Caps: rain cap, exhaust high cone, flute peak cap and Biconical cap
Chapeaux: pare-pluie, cône de finition haute, chapeau de flûte et bicône

2 Abrazadera mural exterior
Exterior wall bracket
Collier mural extérieur

3 Módulo lineal 1.000, 500 y 250 mm
Linear module 1.000, 500 and 250 mm
Élément droit 1.000, 500 and 250 mm

4 Soporte mural intermedio
Intermediate wall support
Support mural intermédiaire

5 Escuadras 150, 250 y 500 mm y escuadras reforzadas 750 y 1.000 mm
Squares 150, 250 and 500 mm and reinforced squares 750 and 1.000 mm
Équerres 150, 250 et 500 mm et équerres renforcés 750 et 1.000 mm

6 Te 90°
"T" piece 90°
Té 90°

7 Tapa condensación
Condensate cap
Tampon purge

8 Módulo de inspección sin tapa
Inspection module without cover
Module d'inspection sans trappe

9 Tapa de inspección
Inspection cover
Trappe d'inspection

10 Codos 15°, 30°, 45° y 87°
Elbows 15°, 30°, 45° and 87°
Coudes 15°, 30°, 45°, et 87°

11 Adaptador caldera antihollín
Anti-soot boiler adapter
Adaptateur chaudière anti-bistre

interior | inside | intérieur
AISI 304
(1.4301) 2R
exterior | outside | extérieur
AISI 304
(1.4301) 2R

UNE-EN 1856-1 : 2010

Ø130-250
T200 P1 W Vm L20040 O(00)
T450 N1 W Vm L20040 O(15)*
T600 N1 W Vm L20040 O(20)
T600 N1 D Vm L20040 O(45)

Ø130-600
T200 P1 W Vm L20050 O(00)
T450 N1 W Vm L20050 O(15)*
T600 N1 W Vm L20050 O(20)
T600 N1 D Vm L20050 O(45)

interior | inside | intérieur
* **AISI 316L**
(1.4404) 2R
exterior | outside | extérieur
AISI 304
(1.4301) 2R

UNE-EN 1856-1 : 2010

Ø130-600
* Consultar Departamento Comercial
Consult Sales Department
Consulter le Département Commercial

* Para cumplir con esta designación todos los elementos deben estar instalados con juntas, consulte la página 120. Para saber el número de juntas, consulte la página 165.

* To comply with this designation, all elements must be installed with gaskets, see page 120. For the number of joints, see page 165.

* Pour respecter cette désignation, tous les éléments doivent être installés avec des joints, voir page 120. Unités de joints par élément, voir page 165

Para el resto de elementos, la junta es opcional.
For all other elements, the gasket is optional.
Pour tous les autres éléments, le joint est optionnel.

Referencia Reference Référence	Ref.	4500001	Unidad de embalaje Packaging unit Unités par emballage
Precio unidad € Unit price, € Prix unité €	€ U.	92,63 1	

Módulo lineal y extensible
Linear and extendable module
Élément droit et télescopique

Módulo lineal | Llinear module | Élément droit



		ØDi				
		130	150	180	200	250
L 1000 mm						
AISI	Ref.	4500000	4500001	4500002	4500003	4500004
304-304	€ U.	85,04 1	92,63 1	106,01 1	124,12 1	153,55 1
L 500 mm						
AISI	Ref.	4500020	4500021	4500022	4500023	4500024
304-304	€ U.	50,72 1	54,52 1	59,78 1	67,15 1	81,42 1
L 250 mm						
AISI	Ref.	4500040	4500041	4500042	4500043	4500044
304-304	€ U.	38,24 1	39,19 1	45,85 1	53,88 1	67,89 1
		ØDe				
		230	250	280	300	350

Módulo extensible | Extendable module | Élément télescopique



		ØDi				
		130	150	180	200	250
Lmin 500 mm - Lmax 900 mm						
AISI	Ref.	4500100	4500101	4500102	4500103	4500104
304-304	€ U.	116,47 1	123,19 1	149,65 1	168,59 1	218,58 1
Lmin 335 mm - Lmax 565 mm						
AISI	Ref.	4500080	4500081	4500082	4500083	4500084
304-304	€ U.	86,50 1	91,02 1	103,59 1	115,88 1	143,03 1
Lmin 200 mm - Lmax 300 mm						
AISI	Ref.	4500060	4500061	4500062	4500063	4500064
304-304	€ U.	64,40 1	68,54 1	78,24 1	95,88 1	110,58 1

		300	350	400	450	500	550	600					
4500005	193,24 1	4500006	230,53 1	4500007	274,38 1	4500008	309,23 1	4500009	344,52 1	4500010	390,37 1	4500011	441,87 1
4500025	99,24 1	4500026	121,24 1	4500027	161,16 1	4500028	193,64 1	4500029	225,57 1	4500030	264,18 1	4500031	297,15 1
4500045	81,65 1	4500046	98,84 1	4500047	131,58 1	4500048	156,06 1	4500049	179,52 1	4500050	202,98 1	4500051	228,48 1
		400	450	500	550	600	650	700					

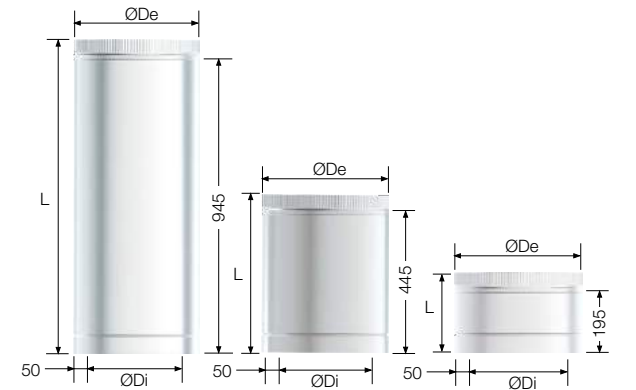

		300	350	400	450	500	550	600					
4500105	258,82 1	4500106	317,97 1	4500107	362,59 1	4500108	392,70 1	4500109	421,20 1	4500110	453,20 1	4500111	491,64 1
4500085	176,69 1	4500086	208,22 1	4500087	253,98 1	4500088	292,95 1	4500089	320,12 1	4500090	349,44 1	4500091	380,07 1
4500065	138,52 1	4500066	175,71 1	4500067	227,70 1	4500068	265,20 1	4500069	294,78 1	4500070	324,45 1	4500071	352,56 1



Codo
Elbow
Coude

Codo | Elbow | Coude **15°**



		ØDi				
		130	150	180	200	250
AISI	Ref.	4500120	4500121	4500122	4500123	4500124
304-304	€ U.	49,33 1	54,75 1	62,74 1	70,26 1	88,70 1
Especificaciones técnicas Technical specifications Spécifications techniques						
H		12	13	13	13	14
V		136	139	143	145	152
		Ø				
		130	150	180	200	250
CDP 15° +L(1000)+ CDP 15°	H1	36	36	37	38	40
	V1	271	276	284	289	302
CDP 15° +L(500)+ CDP 15°	H1	86	87	88	88	90
	V1	458	463	471	476	489
CDP 15° +L(250)+ CDP 15°	H1	151	151	152	153	155
	V1	699	705	715	718	730
CDP 15° +L(100)+ CDP 15°	H1	280	281	282	282	284
	V1	1182	1187	1195	1200	1213

CDP: Codo Doble Pared | Double Wall elbow | Coude Double Paroi

		300	350	400	450	500	550	600					
4500125	120,56 1	4500126	161,00 1	4500127	219,84 1	4500128	261,45 1	4500129	310,75 1	4500130	379,50 1	4500131	443,90 1
15	30	31	32	33	34	35							
158	278	285	291	298	304	311							
		300	350	400	450	500	550	600					
41	73	75	76	78	80	82							
315	555	568	581	594	607	620							
92	125	127	128	130	132	133							
502	748	761	774	787	800	813							
156	190	191	193	195	196	198							
743	990	1003	1016	1029	1042	1054							
286	319	321	322	324	326	327							
1226	1472	1486	1489	1512	1525	1537							

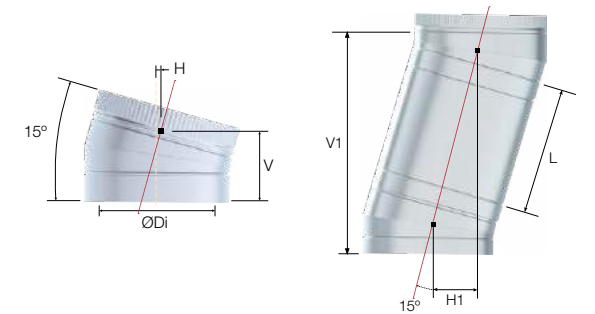

Referencia Reference Référence	Ref.	4500141	Unidad de embalaje Packaging unit Unités par emballage
Precio unidad € Unit price, € Prix unité €	€ U.	60,23 1	

Codo
Elbow
Coude

Codo | Elbow | Coude 30°



		ØDi				
		130	150	180	200	250
AISI	Ref.	4500140	4500141	4500142	4500143	4500144
304-304	€ U.	54,26 1	60,23 1	69,01 1	77,29 1	97,57 1
Especificaciones técnicas Technical specifications Spécifications techniques						
H		32	33	35	36	40
V		161	166	173	178	191
		Ø				
		130	150	180	200	250
CDP 30° + CDP 30°	H1	85	87	91	94	101
	V1	315	325	340	350	375
CDP 30° +L(250)+ CDP 30°	H1	181	184	188	191	197
	V1	483	493	508	518	543
CDP 30° +L(500)+ CDP 30°	H1	306	309	313	316	322
	V1	700	710	725	735	760
CDP 30° +L(1000)+ CDP 30°	H1	556	559	563	566	572
	V1	1133	1143	1158	1168	1193

CDP: Codo Doble Pared | Double Wall elbow | Coude Double Paroi

Codo | Elbow | Coude 45°



		ØDi				
		130	150	180	200	250
AISI	Ref.	4500160	4500161	4500162	4500163	4500164
304-304	€ U.	55,61 1	61,84 1	77,34 1	89,88 1	109,38 1
Especificaciones técnicas Technical specifications Spécifications techniques						
H		54	57	61	63	70
V		178	185	195	202	219
		Ø				
		130	150	180	200	250
CDP 45° + CDP 45°	H1	137	143	151	156	170
	V1	344	358	378	392	426
CDP 45° +L(250)+ CDP 45°	H2	270	280	295	305	330
	V2	259	269	283	292	316
CDP 45° +L(500)+ CDP 45°	H1	271	276	284	290	304
	V1	485	498	519	533	567
CDP 45° +L(1000)+ CDP 45°	H2	411	420	435	445	470
	V2	393	402	416	426	450
CDP 45° +L(500)+ CDP 45°	H1	443	448	456	462	476
	V1	666	679	700	714	748
CDP 45° +L(1000)+ CDP 45°	H2	592	602	617	627	652
	V2	565	574	588	598	622
CDP 45° +L(1000)+ CDP 45°	H1	787	792	800	806	820
	V1	1029	1042	1063	1077	1111
CDP 45° +L(1000)+ CDP 45°	H2	954	964	974	989	1014
	V2	909	919	933	942	966

CDP: Codo Doble Pared | Double Wall elbow | Coude Double Paroi

Codo | Elbow | Coude 87°



		ØDi				
		130	150	180	200	250
AISI	Ref.	4500180	4500181	4500182	4500183	4500184
304-304	€ U.	92,39 1	112,42 1	134,27 1	151,60 1	164,61 1
Especificaciones técnicas Technical specifications Spécifications techniques						
H		160	170	184	194	217
V		212	222	237	247	272

		300	350	400	450	500	550	600
4500145	4500146	4500147	4500148	4500149	4500150	4500151		
132,61 1	177,10 1	252,82 1	300,67 1	357,36 1	436,43 1	510,49 1		
Especificaciones técnicas Technical specifications Spécifications techniques								
H		43	90	93	97	100	103	107
V		203	384	396	409	421	434	446
		Ø						
		300	350	400	450	500	550	600
CDP 30° + CDP 30°	H1	107	204	211	217	224	231	237
	V1	400	761	786	811	836	861	886
CDP 30° +L(250)+ CDP 30°	H1	204	304	311	317	324	331	337
	V1	568	934	960	985	1010	1035	1060
CDP 30° +L(500)+ CDP 30°	H1	329	429	436	442	449	456	462
	V1	785	1151	1176	1201	1226	1251	1276
CDP 30° +L(1000)+ CDP 30°	H1	579	679	686	692	699	706	712
	V1	1218	1584	1609	1634	1659	1684	1709

		300	350	400	450	500	550	600
4500165	4500166	4500167	4500168	4500169	4500170	4500171		
145,67 1	196,96 1	280,35 1	333,96 1	390,00 1	473,82 1	550,20 1		
Especificaciones técnicas Technical specifications Spécifications techniques								
H		77	151	159	166	173	181	188
V		236	416	434	451	469	487	504
		Ø						
		300	350	400	450	500	550	600
CDP 45° + CDP 45°	H1	184	339	354	368	383	398	412
	V1	461	818	854	889	925	960	995
CDP 45° +L(250)+ CDP 45°	H2	355	553	578	603	628	653	678
	V2	340	604	630	655	680	705	730
CDP 45° +L(500)+ CDP 45°	H1	317	480	495	510	524	539	554
	V1	602	959	995	1031	1066	1101	1137
CDP 45° +L(1000)+ CDP 45°	H2	495	694	719	744	769	794	819
	V2	473	749	771	796	821	846	871
CDP 45° +L(500)+ CDP 45°	H1	489	657	672	687	701	716	730
	V1	783	1136	1172	1207	1243	1278	1314
CDP 45° +L(1000)+ CDP 45°	H2	677	871	896	921	946	971	996
	V2	645	922	948	973	998	1023	1048
CDP 45° +L(1000)+ CDP 45°	H1	834	1010	1025	1040	1055	1069	1084
	V1	1146	1490	1526	1561	1596	1632	1667
CDP 45° +L(1000)+ CDP 45°	H2	1039	1224	1250	1275	1300	1325	1350
	V2	990	1276	1301	1326	1351	1376	1401

		300	350	400	450	500	550	600
4500185	4500186	4500187	4500188	4500189	4500190	4500191		
208,54 1	275,99 1	387,56 1	550,05 1	673,10 1	811,06 1	980,50 1		
Especificaciones técnicas Technical specifications Spécifications techniques								
H		241	482	507	532	557	582	607
V		297	427	451	475	498	522	546

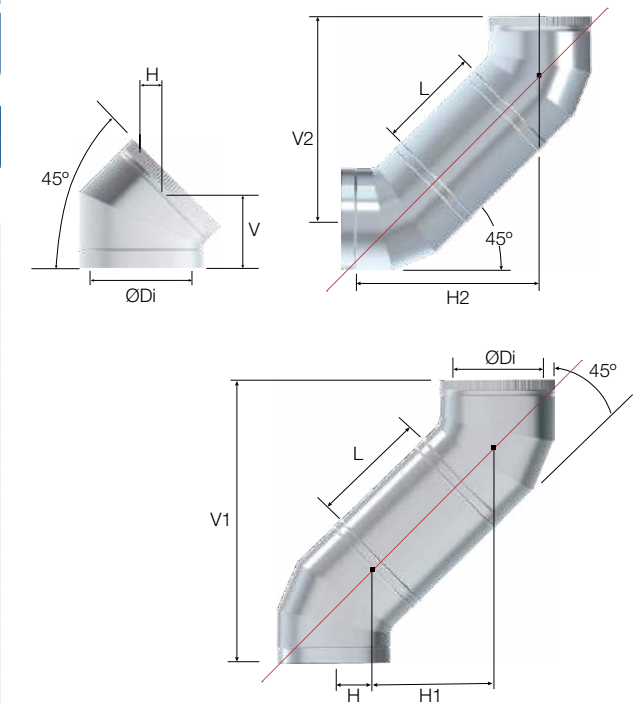
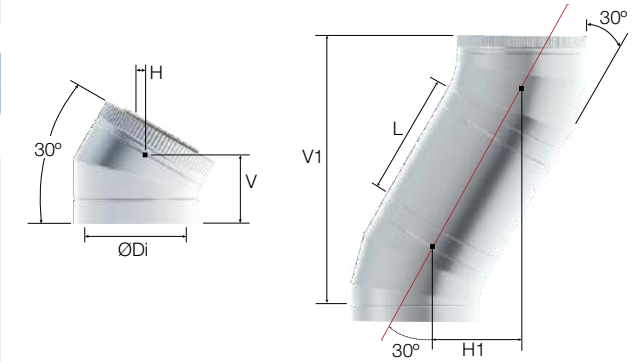

Referencia	Ref.	4500401	Unidad de embalaje
Reference	Ref.	4500401	Packaging unit
Référence	Ref.	4500401	Unités par emballage
Precio unidad €	€ U.	44,07 1	
Unit price €	€ U.	44,07 1	
Prix unité €	€ U.	44,07 1	

Adaptador
Adapter
Adaptateur

Adaptador a campana | Hood adapter | *Adaptateur pour hotte*



		ØDi				
		130	150	180	200	250
AISI	Ref.	4500400	4500401	4500402	4500403	4500404
304-304	€ U.	41,29 1	44,07 1	51,56 1	61,92 1	74,16 1

Adaptador DP-DPEI | DW-DWEI adapter | *Adaptateur DP-DPEI*



		ØDi				
		130	150	180	200	250
AISI	Ref.	4500420	4500421	4500422	4500423	4500424
304-304	€ U.	63,00 1	67,50 1	71,50 1	76,50 1	90,00 1

Adaptador DPEI-DP | DWEI-DW adapter | *Adaptateur DPEI-DP*



		ØDi				
		130	150	180	200	250
AISI	Ref.	4500440	4500441	4500442	4500443	4500444
304-304	€ U.	66,15 1	70,88 1	75,08 1	80,33 1	94,50 1

		300	350	400	450	500	550	600
AISI	Ref.	4500405	4500406	4500407	4500408	4500409	4500410	4500411
304-304	€ U.	91,17 1	111,82 1	125,35 1	134,40 1	143,64 1	151,62 1	160,95 1

		300	350	400	450	500	550	600
AISI	Ref.	4500425	4500426	4500427	4500428	4500429	4500430	4500431
304-304	€ U.	104,50 1	126,50 1	148,29 1	172,29 1	194,06 1	214,75 1	236,48 1

		300	350	400	450	500	550	600
AISI	Ref.	4500445	4500446	4500447	4500448	4500449	4500450	4500451
304-304	€ U.	109,73 1	132,83 1	155,71 1	180,90 1	203,76 1	225,49 1	248,30 1



Adaptador caldera, para aumento-reducción consultar Departamento Técnico



Boiler adapter, for augmentation/reduction, consult Technical Department

Adaptateur de chaudière, pour augmentation/réduction consultez notre Service Technique



Te y tapa
"T" Piece and cover
Té et tampon

Te | "T" piece | Té **90° ***



		ØDi				
		130	150	180	200	250
AISI	Ref.	4500200	4500201	4500202	4500203	4500204
304-304	€ U.	92,83 1	94,73 1	110,45 1	129,48 1	177,78 1

Especificaciones técnicas Technical specifications Spécifications techniques						
	L	388	408	456	488	508
	V	208	218	233	243	268
	H	194	204	228	244	254

* No incluye tapas | No caps included | Tampons non compris

		300	350	400	450	500	550	600
AISI	Ref.	4500205	4500206	4500207	4500208	4500209	4500210	4500211
304-304	€ U.	219,16 1	319,36 1	477,09 1	577,32 1	705,60 1	796,19 1	924,94 1

	588	700	750	800	850	900	950
	293	350	375	345	370	395	420
	279	294	320	345	370	395	420

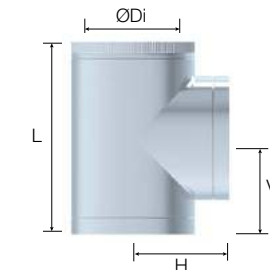

Te | "T" piece | Té **135° ***



		ØDi				
		130	150	180	200	250
AISI	Ref.	4500220	4500221	4500222	4500223	4500224
304-304	€ U.	143,30 1	167,53 1	165,28 1	211,16 1	317,83 1

Especificaciones técnicas Technical specifications Spécifications techniques						
	L	478	507	549	577	648
	V	86	93	104	111	129
	H	268	285	311	328	371

* No incluye tapas | No caps included | Tampons non compris

		300	350	400	450	500	550	600
AISI	Ref.	4500225	4500226	4500227	4500228	4500229	4500230	4500231
304-304	€ U.	378,85 1	495,10 1	699,66 1	829,67 1	945,05 1	1.074,15 1	1.198,89 1

	719	793	863	934	1005	1075	1146
	146	165	183	201	218	236	254
	413	458	500	543	586	629	672



Tapa | Plug | Tampon



		ØDi				
		130	150	180	200	250
AISI	Ref.	4500240	4500241	4500242	4500243	4500244
304-304	€ U.	24,53 1	26,03 1	30,40 1	33,99 1	41,37 1

		300	350	400	450	500	550	600
AISI	Ref.	4500245	4500246	4500247	4500248	4500249	4500250	4500251
304-304	€ U.	56,47 1	84,95 1	110,67 1	123,75 1	142,48 1	156,45 1	167,40 1

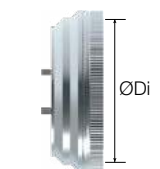

Tapa purga | Purge plug | *Tampon récupérateur condensats*



		ØDi				
		130	150	180	200	250
AISI	Ref.	4500260	4500261	4500262	4500263	4500264
304-304	€ U.	27,71 1	29,30 1	33,65 1	37,93 1	44,55 1

Especificaciones técnicas Technical specifications Spécifications techniques						
	ØG	1/2"	3/4"	3/4"	3/4"	3/4"

		300	350	400	450	500	550	600
AISI	Ref.	4500265	4500266	4500267	4500268	4500269	4500270	4500271
304-304	€ U.	58,86 1	85,62 1	137,08 1	159,51 1	174,42 1	184,83 1	201,96 1

	1"	1"	1"	1"	1"	1"	1"
--	----	----	----	----	----	----	----



Sifón | Siphon | Siphon

Ref.	4030741
€ U.	29,15 1

max. 160° C

Referencia Reference Référence	Ref.	4500281	Unidad de embalaje Packaging unit Unités par emballage
Precio unidad € Unit price, € Prix unité €	€ U.	126,72 1	

Módulo de inspección
Inspection module
Module d'inspection

Módulo de inspección | Inspection module | *Module inspection **



		ØDi				
		130	150	180	200	250
AISI	Ref.	4500280	4500281	4500282	4500283	4500284
304-304	€ U.	120,93 1	126,72 1	147,37 1	168,59 1	180,15 1
Especificaciones técnicas Technical specifications Spécifications techniques						
	L	388	408	456	488	508
	ØT	130	150	180	200	250

* No incluye tapas | No caps included | *Tampons non compris*

		300	350	400	450	500	550	600
	Ref.	4500285	4500286	4500287	4500288	4500289	4500290	4500291
	€ U.	218,02 1	260,87 1	365,75 1	430,80 1	494,40 1	567,21 1	630,00 1
	L	558	570					
	ØT	300						



Tapa
Cover
Trappe

Tapa de inspección | Inspection plug | *Trappe d'inspection 200°C / 200 Pa*



Resistente a la humedad
Moisture resistant
Inensible à l'humidité

		ØT mm				
		130	150	180	200	250
AISI	Ref.	5003267	5003268	5003269	5003270	5003271
304	€ U.	22,29 1	24,61 1	32,36 1	35,07 1	51,53 1

		300 - 600	
	Ref.	5003272	
	€ U.	63,41 1	

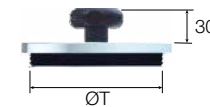

Tapa de inspección | Inspection plug | *Trappe d'inspection 450°C / 40 Pa*



Para combustibles sólidos
For solid fuels
Pour combustibles solides

		ØT mm				
		130	150	180	200	250
AISI	Ref.	5003393	5003394	5003395	5003396	5003397
304	€ U.	34,26 1	38,33 1	44,04 1	48,67 1	72,14 1

		300 - 600	
	Ref.	5003398	
	€ U.	88,77 1	

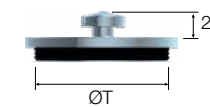

SopORTE
Support
Support

SopORTE mural intermedio | Intermediate wall support | *Support mural intermédiaire*



		ØDi				
		130	150	180	200	250
AISI	Ref.	4500380	4500381	4500382	4500383	4500384
304-304	€ U.	85,32 1	90,68 1	91,13 1	112,66 1	141,39 1
Especificaciones técnicas Technical specifications Spécifications techniques						
	A	263	283	313	333	383
	B	343	363	343	413	463

		300	350	400	450	500	550	600
	Ref.	4500385	4500386	4500387	4500388	4500389	4500390	4500391
	€ U.	174,30 1	242,55 1	282,25 1	334,55 1	413,28 1	534,75 1	626,75 1
	A	433	483	533	583	633	683	733
	B	513	563	613	663	713	763	813

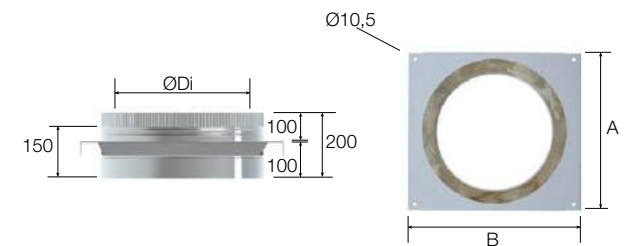

Accesorios
Accessories
Accessoires

Collarín | Storm collar | *Collerette 75mm*



		ØDi				
		130	150	180	200	250
AISI	Ref.	4019987	4019988	4019989	4019990	4019991
304-304	€ U.	36,89 1	41,20 1	47,93 1	51,50 1	67,98 1
	ØDe	230	250	280	300	350

		300	350	400	450	500	550	600
	Ref.	4021062	4033536	4030214	4033537	4033538	4033540	4033542
	€ U.	77,68 1	88,61 1	92,19 1	109,18 1	122,57 1	136,89 1	146,26 1
	ØDe	400	450	500	550	600	650	700

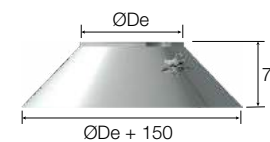

Sombrero
Cap
Chapeau

Sombrero antilluvia | Rain cap | *Chapeau pare-pluie*



		ØDi				
		130	150	180	200	250
AISI	Ref.	4500300	4500301	4500302	4500303	4500304
304-304	€ U.	50,46 1	53,42 1	63,83 1	72,83 1	96,68 1
Especificaciones técnicas Technical specifications Spécifications techniques						
	V	143	143	143	180	180
	ØDs	350	400	450	500	550

		300	350	400	450	500	550	600
	Ref.	4500305	4500306	4500307	4500308	4500309	4500310	4500311
	€ U.	136,21 1	179,70 1	229,90 1	280,54 1	328,00 1	362,40 1	390,88 1
	V	193	193	193	193	193	193	193
	ØDi	600	650	700	750	800	850	900

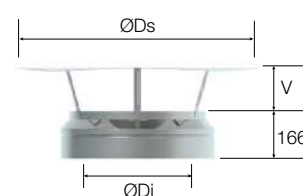

Referencia Reference Référence	Ref.	4500321	Unidad de embalaje Packaging unit Unités par emballage
Precio unidad € Unit price, € Prix unité €	€ U.	48,75 1	

Sombrero
Cap
Chapeau

Sombrero salida libre | Exhaust high cone | Cône de finition haute



		ØDi				
		130	150	180	200	250
AISI 304-304	Ref.	4500320	4500321	4500322	4500323	4500324
	€ U.	46,81 1	48,75 1	50,87 1	58,78 1	76,41 1

Sombrero pico flauta | Lateral cap | Chapeau de flûte



		ØDi				
		130	150	180	200	250
AISI 304-304	Ref.	4500340	4500341	4500342	4500343	4500344
	€ U.	64,82 1	74,04 1	86,84 1	102,49 1	117,60 1

Sombrero bicónico | Biconical cap | Chapeau bicône



		ØDi				
		130	150	180	200	250
AISI 304-304	Ref.	4500360	4500361	4500362	4500363	4500364
	€ U.	402,16 1	489,25 1	553,83 1	577,32 1	704,32 1

Especificaciones técnicas Technical specifications Spécifications techniques						
	ØDS	155	180	215	240	300
	ØDC	233	268	313	353	440
		357	387	437	467	547

	300	350	400	450	500	550	600
4500325	4500326	4500327	4500328	4500329	4500330	4500331	
103,57 1	135,24 1	167,17 1	198,22 1	230,34 1	261,12 1	292,73 1	

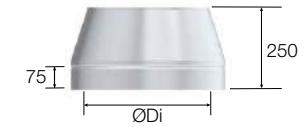

	300	350	400	450	500	550	600
4500345	4500346	4500347	4500348	4500349	4500350	4500351	
133,82 1	158,83 1	192,00 1	218,75 1	254,80 1	292,50 1	327,68 1	

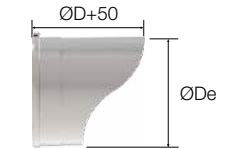

	300	350	400	450	500	550	600
4500365	4500366	4500367	4500368	4500369	4500370	4500371	
875,76 1	993,18 1	1154,63 1	1359,14 1	1492,21 1	1736,84 1	1920,80 1	



360	420	480	540	600	660	720
525	615	700	790	885	980	1075
627	707	787	867	947	1027	1107

Junta
Gasket
Joint

Junta silicona | Silicone gasket | Joint silicone



		ØDi				
		130	150	180	200	250
Ref.		5003951	5003952	5003953	5003954	5003957
	€ U.	1,38 10	1,83 10	2,68 10	2,99 10	4,01 10

Lubricante silicona | Silicone lubricant | Graisse silicone



150ml	
Ref.	5002932
€ U.	6,10 1

	300	350	400	450	500	550	600
5003958	5003959	5003960	5005716	5005717	5005718	5005719	
5,54 5	7,55 5	9,48 5	11,85 1	14,21 1	16,48 1	19,06 1	

Cubreaguas y sujeción a techo
Roof flashing and adjustable roof support
Solin et support au toit réglable

Cubreaguas inoxidable horizontal + collarín | Horizontal stainless steel roof flashing + Storm collar

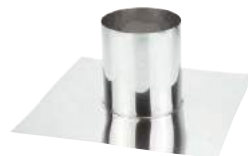

		ØDi				
		130	150	180	200	250
AISI 304-304	Ref.	2500210	2700942	4009578	2700943	2700938
	€ U.	114,59 1	119,46 1	145,83 1	163,41 1	203,37 1

Especificaciones técnicas Technical specifications Spécifications techniques		
A	490	700

Solin inox. horizontal + collarète

	300	350	400	450	500	550	600
4009572	2500214	5002662	4009579	4009580	4009581	4009582	
255,43 1	277,07 1	304,88 1	327,54 1	349,17 1	367,71 1	389,34 1	

700	1000
-----	------

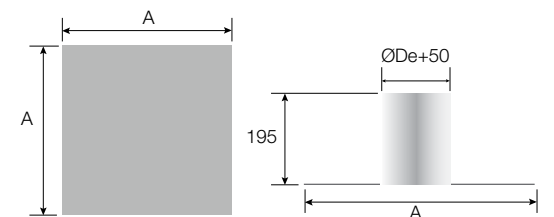

Cubreaguas atornillar | Screwed flashing | Solin à visser

Kit fijación | Fastening Kit | Kit fixation



		ØDi	
		130-200	250-600
EPDM	< 150°	Ref. 5003946	5005824
		€ U. 96,66 1	418,86 1
SILICONE	< 200°	Ref. 5005826	5005827
		€ U. 137,74 1	723,34 1



Ref.	4035363
€ U.	26,44 1

Cubreaguas residencial | Residential flashing | Solin Résidentiel

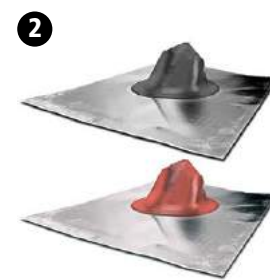

		ØDi	
		130-180	200-350
EPDM	< 150°	Ref. 5005830	5005831
		€ U. 118,54 1	250,73 1
SILICONE	< 200°	Ref. 5005833	5005834
		€ U. 132,44 1	301,78 1



Referencia Reference Référence	Ref.	4019881	Unidad de embalaje Packaging unit Unités par emballage
Precio unidad € Unit price, € Prix unité €	€ U.	46,70 1	

Abrazadera
Bracket
Bride, Collier

Abrazadera mural exterior | External wall bracket | Collier support mural extérieur



● Ø 130-300 ● Ø 350-600

		ØDi	130	150	180	200	250
AISI 304	Ref.		4019880	4019881	4031702	4019882	4020326
	€ U.		43,25 1	46,70 1	55,59 1	61,52 1	62,92 1
Especificaciones técnicas Technical specifications Spécifications techniques		A	185	205	235	255	305
		ØDe	230	250	280	300	350

Abrazadera mural interior | Interior wall bracket | Bride murale intérieur



● Ø 130-300 ● Ø 350-600

		ØDi	130	150	180	200	250
AISI 304	Ref.		5001351	2500042	2500509	2500043	2500510
	€ U.		17,52 2	18,69 2	21,47 2	24,04 2	32,91 2
Especificaciones técnicas Technical specifications Spécifications techniques		A	-	-	-	-	-
		d	160	160	160	200	200

Prolongación mural (2 unidades) | Wall extension (2 units) | Rallonge murale (2 unités)



		L	150 mm	250 mm	500 mm	750 mm	1000 mm
AISI 304	Ref.		4019959	4019960	5004657	5004656	5004655
	€ U.		25,82 1	32,32 1	125,21 1	150,21 1	169,96 1

Abrazadera unión ancha | Wide connection bracket | Collier de fixation large



		ØDi	130	150	180	200	250
AISI 304	Ref.		5005363	5005364	5005563	5005564	5005565
	€ U.		8,24 1	9,18 1	10,13 1	10,40 1	11,79 1

Abrazadera de vientos | Roof brace band | Bride pour haubanage



		ØDi	130	150	180	200	250
AISI 304	Ref.		2700214	2700354	4014614	2700403	2700323
	€ U.		29,66 1	30,46 1	34,87 1	38,86 1	52,95 1

Abrazadera forjado | Ceiling bracket | Collier support plancher



		ØDi	130	150	180	200	250
AISI 304	Ref.		5001470	5001471	5001474	5001456	5001472
	€ U.		35,71 1	36,82 1	49,23 1	52,02 1	53,98 1

Abrazadera forjado reforzada | Reinforced ceiling bracket | Collier support plancher renforcé



		ØDi	130	150	180	200	250
AISI 304	Ref.		4026829	4023222	4026830	4023223	4023224
	€ U.		35,10 1	35,62 1	37,55 1	38,84 1	39,83 1
Especificaciones técnicas Technical specifications Spécifications techniques		A	103	103	138	138	138
		B	250	250	300	300	300

	300	350	400	450	500	550	600
4020327	4031696	4031697	4031698	4031699	4031700	4031701	
€ U.	64,32 1	136,99 1	159,92 1	182,57 1	204,23 1	233,81 1	266,77 1
	355	405	455	505	555	605	655
	400	450	500	550	600	650	700

	300	350	400	450	500	550	600
2500044	4035019	4035066	4035067	4035068	4035069	4035070	
€ U.	46,55 2	61,43 1	71,07 1	81,86 1	91,57 1	104,84 1	119,62 1
	-	405	455	505	555	605	655
	270	373	423	472	522	575	622

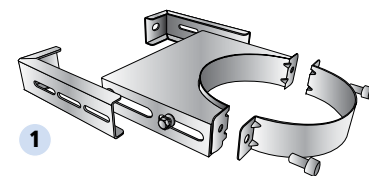

1 Para soporte mural interior y exterior (Ø130-Ø300)
For indoor and outdoor wall clamps (Ø130-Ø300)
Pour support mural intérieur et extérieur (Ø130-Ø300)

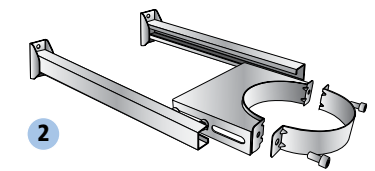
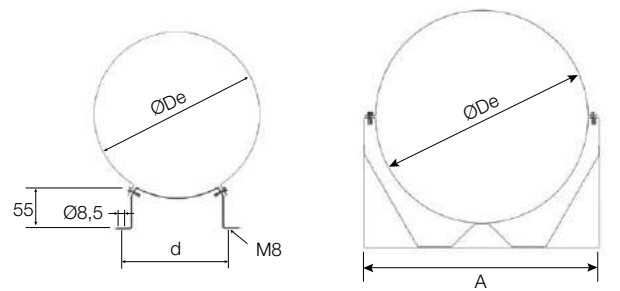
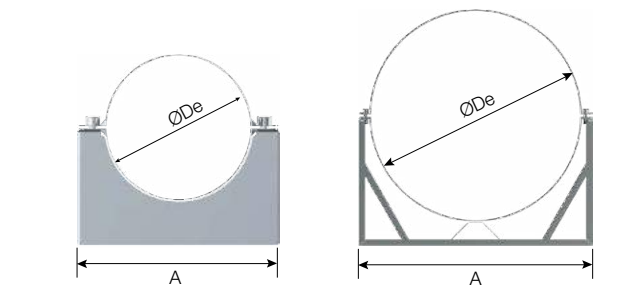

2 Para soporte mural interior (Ø350-Ø600) y exterior (Ø130-Ø600)
For indoor (Ø350-Ø600) and outdoor wall clamps (Ø130-Ø600)
Pour support mural intérieur (Ø350-Ø600) et extérieur (Ø130-Ø600)

	300	350	400	450	500	550	600
5005566	5005567	5005568	5005569	5005570	5005571	5005572	
€ U.	13,55 1	15,08 1	16,68 1	18,05 1	19,28 1	20,81 1	22,38 1

	300	350	400	450	500	550	600
2700418	4014608	4014609	4014610	4014611	4014612	4014613	
€ U.	60,52 1	65,71 1	69,42 1	72,34 1	75,65 1	78,69 1	80,85 1

	300	350	400	450	500	550	600
5001473	5001475	5001476	5001477	5001478	5001479	5001480	
€ U.	56,62 1	69,62 1	72,30 1	74,31 1	77,50 1	81,16 1	83,73 1

	300	350	400	450	500	550	600
4023225	4023226	4026831	4026832	4026833	4026834	4026835	
€ U.	41,27 1	44,29 1	45,66 1	48,65 1	54,14 1	57,11 1	60,67 1
	138	138	173	173	173	173	173
	300	300	350	350	350	350	350

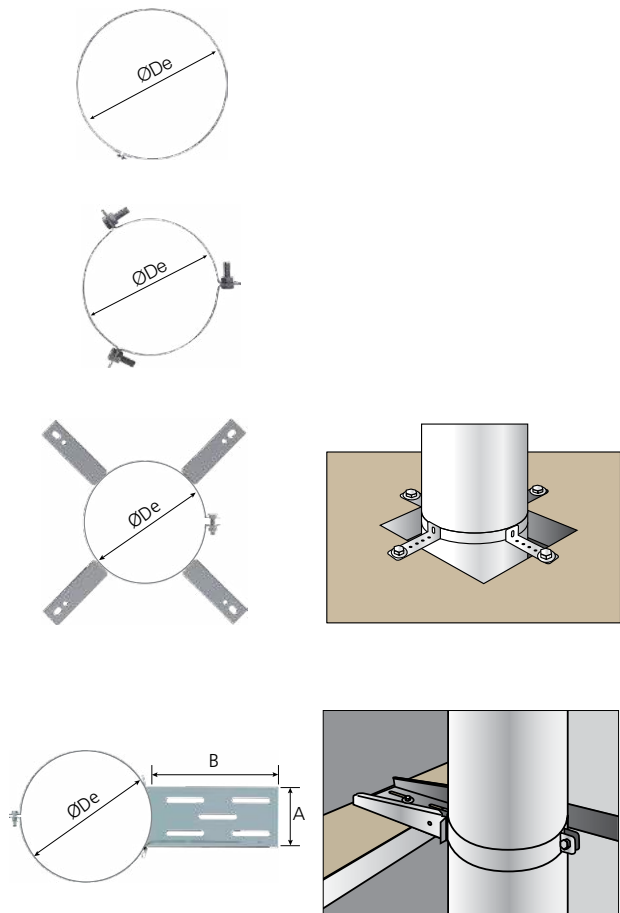

Referencia Reference Référence	Ref.	4012428	Unidad de embalaje Packaging unit Unités par emballage
Precio unidad € Unit price, € Prix unité €	€ U.	69,35 1	

Soporte
Support
Support

Soporte a techo regulable | Adjustable roof support | Support au toit réglable



		ØDi	130	150	180	200	250
AISI 304	Ref.		4013295	4012428	4090053	4015588	4015660
	€ U.		68,79 1	69,35 1	70,50 1	71,27 1	71,63 1
Especificaciones técnicas Technical specifications Spécifications techniques							
	L		733	753	783	803	855
		ØDe	230	250	280	300	350

Soporte mural universal | Universal wall support | Support mural universel



		ØDi	130	150	180	200	250
AISI 304	Ref.		4026053	4026054	4026058	4026059	4026060
	€ U.		80,92 1	86,98 1	98,57 1	106,37 1	123,23 1
Especificaciones técnicas Technical specifications Spécifications techniques							
	A		263	283	313	333	383
	B		343	363	393	413	463

Escuadra soporte mural (2 unidades) | Square wall support (2 units) | Équerre support mural (2 unités)



	Mediano Medium Moyen	Grande Large Grand
Ref.	4019926	4019927
€ U.	68,70 1	72,05 1
Espec. técnicas Technical specif. Spécif. techniques		
L	360	515
H	430	610

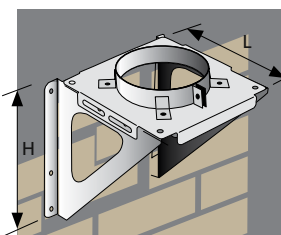

Escuadra con soporte mural
Square with wall support
Équerre avec support mural

* Consultar el tamaño adecuado en la página 165.
Refer to the appropriate size on page 165.
Voir la taille appropriée à la page 165

Escuadra reforzada (2 unidades) | Reinforced square (2 units) | Support renforcé (2 unités)



	L500 mm	L750 mm	L1000 mm
Ref.	5003914	5003915	5003916
€ Kit	141,15 1	173,25 1	215,56 1
Espec. técnicas Technical specif. Spécif. techniques			
	310	470	600

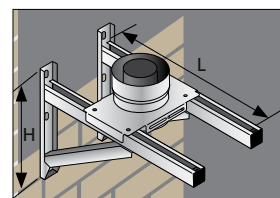

Escuadra reforzada con soporte mural
Reinforced square with wall support
Support renforcé avec support mural

300	350	400	450	500	550	600
4014552	4040054	4040055	4040056	4040057	4040058	4040059
72,45 1	97,85 1	100,94 1	104,03 1	107,13 1	110,21 1	113,30 1
905	955	1005	1055	1105	1155	1205
400	450	500	550	600	650	700

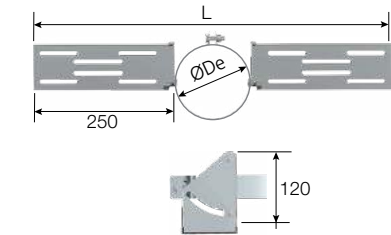

300	350	400	450	500	550	600
4026061	4026062	4026063	4026064	4026066	4026067	4026069
138,23 1	176,62 1	209,61 1	243,60 1	271,92 1	303,64 1	339,90 1
435	485	535	585	635	685	735
515	565	615	665	715	765	815

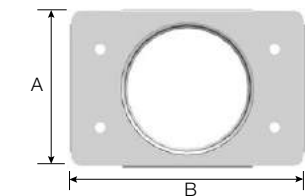

Kit fijación reforzado universal (2 unidades) | Universal reinforced kit (2 units) | Kit fixation renforcé universel (2 unités)



		1000 mm
Ref.		4026055
€ U.		45,54 1

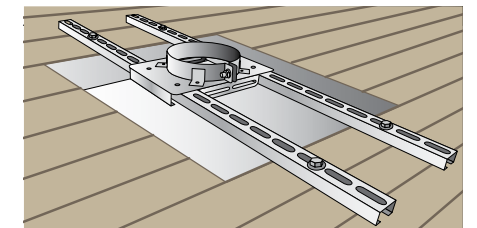

Kit fijación soporte mural universal
Universal wall support fastening kit
Kit de fixation universelle support mural

Fijación forjado angular (2 unidades) | Angular forged fixation (2 units) | Fixation angulaire (2 unités)



		1000 mm
Ref.		4026057
€ U.		31,62 1

Consultar las diferentes opciones de soporte en la página 165 | For support options, see page 165 | Pour les options d'assistance, voir page 165.



Ensayo vertical
Vertical test
Essai vertical



Ensayo horizontal
Horizontal test
Essai horizontal

ESPECIFICACIONES TÉCNICAS | TECHNICAL FEATURES | SPÉCIFICATIONS TECHNIQUES

Sistema Doble Pared con 50 mm de aislamiento en lana de roca y una resistencia al fuego de 30 min. y 60 min. Especialmente diseñado para la extracción de campanas de cocina industrial.
Double Wall System with 50 mm rockwool insulation and 30 and 60 minutes fire resistance. Specially designed for extraction of industrial kitchen hoods.
Système Double Paroi avec 50 mm d'isolation en laine de roche et une résistance au feu de cheminée pendant 30 et 60 min. Spécialement conçu pour l'extraction de hottes de cuisine industrielle.

CLASIFICACIÓN | CLASSIFICATION | CLASSEMENT EI30 EI60 (UNE-EN 13501-3: 2010)

EI 30 (ve i ↔ o)	Ensayo nº Test No. Essai n°	17/15180-1958
EI 30 (ho i ↔ o)	Ensayo nº Test No. Essai n°	17/13563-1342
EI 60 (ve i ↔ o)	Ensayo nº Test No. Essai n°	17/15180-1958
EI 60 (ho i ↔ o)	Ensayo nº Test No. Essai n°	17/13563-1342

DESIGNACIÓN | DESIGNATION | DÉSIGNATION (UNE-EN 1856-1: 2010)

AISI 304	T600 N1 D Vm L20040 G(45)	AISI 316L*	T600 N1 D V2 L50040 G(45)
	T450 N1 W Vm L20040 O(15)		T450 N1 W V2 L50040 O(15)
	T200 P1 W Vm L20040 O(00)		T200 P1 W V2 L50040 O(00)

* Consultar Departamento Comercial | Consult Sales Department | Consultez le Service Commercial



**DEPRESIÓN
DEPRESSION
DÉPRESSION**

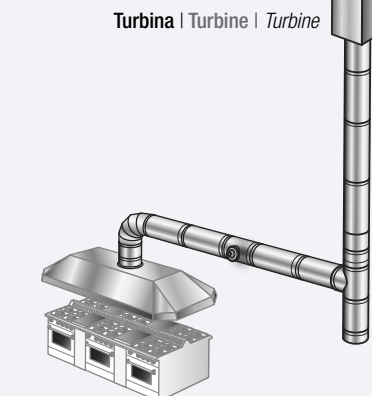

Uso de junta recomendado
Gasket use is recommended
Utilisation du joint recommandée

**SOBREPRESIÓN
OVERPRESSURE
SURPRESSION**

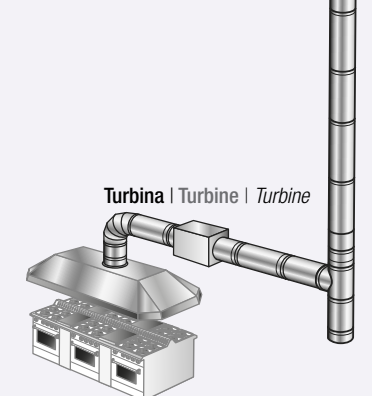

Uso de junta obligado
Gasket use is mandatory
Utilisation de joint obligatoire

12 CC

Conducto Concéntrico
Concentric Piping
Conduit concentrique

Ø80/125 - 130/200



1 Sombreros: salida vertical y salida horizontal
Caps: Vertical and horizontal exit cap
Chapeaux: sortie verticale et sortie horizontale

2 Collarín
Storm collar
Collerette

3 Cubreaguas 5°-25°, 25°-45°, 45°-60° y cubreaguas inox. horizontal
Roof flashing 5°-25°, 25°-45°, 45°-60° and horizontal SS roof flashing
Solin toit 5°-25°, 25°-45°, 45°-60° et solin inox. horizontal

4 Codos 30°, 45° y 87°
Elbows 30°, 45° and 87°
Coudes 30°, 45° et 87°

5 Soporte techo regulable, abrazadera forjado reforzada y abrazadera forjado
Adjustable roof support, reinforced ceiling bracket and ceiling bracket
Support au toit réglable, collier support plancher renforcé et collier support plancher

6 Módulo lineal 1.000 mm, 500 mm, 250 mm
Linear module 1000 mm, 500 mm, 250 mm
Élément droit 1.000 mm, 500 mm, 250 mm

7 Te 90° con tapa, te 90° admisión reducida, te 93° salida gas con tapa purga
"T" piece 90° with cap, 90° reduction "T" piece air inlet to, 93° "T" piece gas outlet with purge cap
Té 93° avec trappe, té 90° admission réduit, té 93° sortie gaz avec tampon purge

8 Sombrero salida horizontal
Horizontal outlet cap
Chapeau sortie horizontale

9 Adaptador caldera 80/125, 80/130
Boiler adapter 80/125, 80/130
Adaptateur chaudière 80/125, 80/130

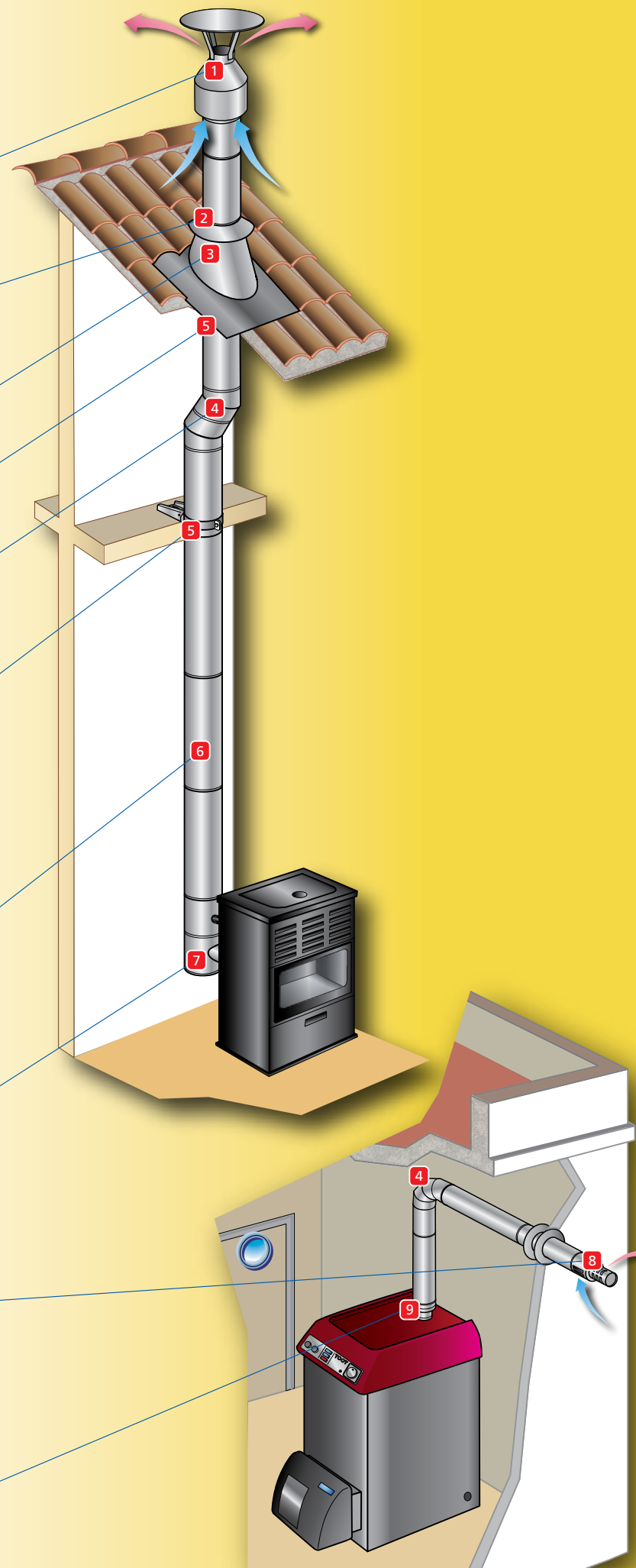

CE Especificaciones de acuerdo a la legislación europea en productos de construcción CPR
Specifications according to EU product regulations of construction CPR
Spécifications Selon la réglementation européenne concernant les produits de construction CPR

interior | inside | intérieur

AISI 316L

(1.4404) 2R

exterior | outside | extérieur

AISI 304

(1.4301) 2R

EN 14989-2

Ø80/125
-130/200

T200 P1 W V2 L50040 O(20)*

T200 N1 W V2 L50040 O(20)

T450 N1 W V2 L50040 G(100)

interior | inside | intérieur

AISI 316L

(1.4404) 2R

exterior | outside | extérieur

AISI 304

(1.4301) 2R

EN 14989-2

Ø80/125
-130/200

T200 P1 W Vm L20040 O(20)*

T200 N1 W Vm L20040 O(20)

T450 N1 W Vm L20040 G(100)

interior | inside | intérieur

AISI 904L

(1.4539) 2R

exterior | outside | extérieur

AISI 304

(1.4301) 2R

EN 14989-2

Ø80/125
-130/200

T200 P1 W Vm L20040 O(20)*

T200 N1 W Vm L20040 O(20)

T450 N1 W Vm L20040 G(100)

Consulte el Departamento Comercial para más información
Consult Sales Department for more information
Contactez le Service Commercial pour plus d'informations

* Para cumplir con esta designación todos los elementos deben estar instalados con juntas, consulte la página 131. Para saber el número de juntas, consulte la página 165.

* To comply with this designation, all elements must be installed with gaskets, see page 131. For the number of joints, see page 165.

* Pour respecter cette désignation, tous les éléments doivent être installés avec des joints, voir page 131. Unités de joints par élément, voir page 165.

Para el resto de elementos, la junta es opcional.
For all other elements, the gasket is optional.
Pour tous les autres éléments, le joint est optionnel.

Referencia Reference Référence	Ref.	2700555	Unidad de embalaje Packaging unit Unités par emballage
Precio unidad € Unit price, € Prix unité €	€ U.	74,83	1

Incluye juntas Gaskets included Joints inclus	Juntas necesarias Required gaskets Joints nécessaires
	xn

Módulo lineal y extensible
Linear and extendable module
Élément droit et télescopique

Módulo lineal | Llinear module | Élément droit

ØDi / ØDe mm		80/125	80/130	100/150	130/200
L 1000 mm					
AISI	Ref.	4028278	2700144	2700555	4010086
304-304	€ U.	67,40	68,43	74,83	108,84
AISI	Ref.	4025846	4012945	4014581	4016735
316L-304	€ U.	87,63	88,96	97,38	141,50
L 500 mm					
AISI	Ref.	4028281	2700143	2700590	4010087
304-304	€ U.	55,93	56,78	62,92	85,00
AISI	Ref.	4025845	4012944	4014593	4016738
316L-304	€ U.	72,71	73,82	80,34	108,15
L 250 mm					
AISI	Ref.	4028282	2700142	2700612	4010089
304-304	€ U.	42,70	43,35	48,41	68,83
AISI	Ref.	4025844	4015102	4016739	4016740
316L-304	€ U.	55,52	56,65	61,80	87,55

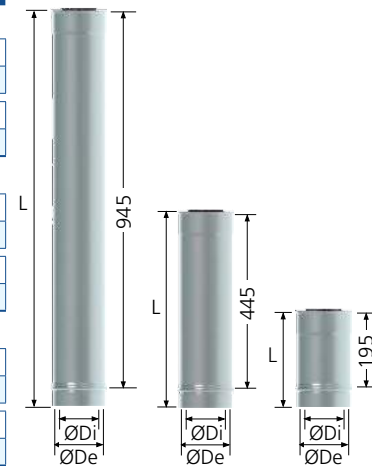

Módulo extensible | Extendable module | Élément télescopique

ØDi / ØDe mm		80/125	80/130	100/150	130/200
Lmin 500 mm - Lmax 900 mm					
AISI	Ref.	4028286	4023100	4023102	4023103
304-304	€ U.	91,25	92,64	99,15	121,51
AISI	Ref.	4025850	9023075	9023076	9023077
316L-304	€ U.	118,61	120,43	128,89	157,97
Lmin 335 mm - Lmax 565 mm					
AISI	Ref.	4028283	2700517	2700581	4010090
304-304	€ U.	81,47	82,71	88,52	108,49
AISI	Ref.	4025849	4012946	4014592	4016741
316L-304	€ U.	105,91	107,52	115,08	141,04

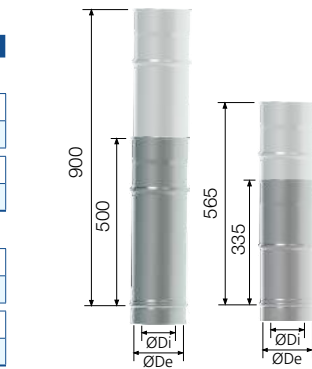

Codo
Elbow
Coude

Codo | Elbow | Coude 30°

ØDi / ØDe mm		80/125	80/130	100/150	130/200
AISI	Ref.	4028289	4023122	4023123	4023125
304-304	€ U.	43,44	45,32	50,47	66,95
AISI	Ref.	4028305	4023088	4023089	4023090
316L-304	€ U.	56,47	57,33	64,00	82,40
Especificaciones técnicas Technical specifications Spécifications techniques					
	H	45	46	48	51
	V	129	130	135	147

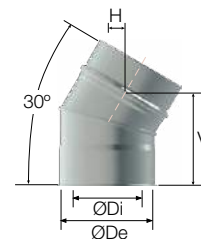

Codo | Elbow | Coude 45°

ØDi / ØDe mm		80/125	80/130	100/150	130/200
AISI	Ref.	4028290	2700139	2700556	4010092
304-304	€ U.	44,63	46,35	51,50	67,98
AISI	Ref.	4027144	4012947	4014583	4016744
316L-304	€ U.	58,02	58,92	66,36	82,73
Especificaciones técnicas Technical specifications Spécifications techniques					
	H	72	73	75	82
	V	131	132	139	156



Codo | Elbow | Coude 87°

ØDi / ØDe mm		80-125	80-130	100-150	130-200
AISI	Ref.	4028291	2700140	2700580	4010093
304-304	€ U.	68,10	69,14	82,40	105,06
AISI	Ref.	4025847	4012948	4014584	4016745
316L-304	€ U.	88,54	89,89	106,09	135,96
Especificaciones técnicas Technical specifications Spécifications techniques					
	H	112	114	124	146
	V	162	163	173	194

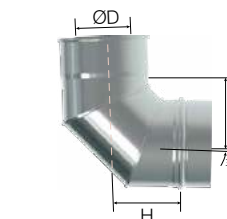

Adaptador
Adapter
Adaptateur

Adaptador caldera | Boiler adapter | Adaptateur chaudière

ØDi / ØDe mm		80/125	80/130	100/150	130/200
AISI	Ref.	4028293	4023107	2700613	4015213
304-304	€ U.	30,61	31,08	32,70	41,01
AISI	Ref.	4028306	9023112	4014586	4016743
316L-304	€ U.	39,80	40,41	42,50	53,32
Especificaciones técnicas Technical specifications Spécifications techniques					
	ØDni	82	82	102	132
	ØDNe	127	132	152	202

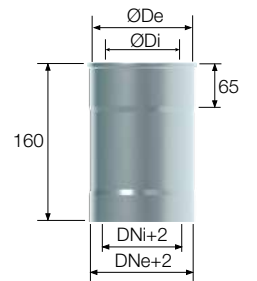

Adaptador conector aumento | Augmentation connection adapter | Adaptateur raccord augmentation

ØDi / ØDe mm		60/100	80/110	80/125	
AISI	Ref.	80/130	4023109	4023344	4012949
316L-304	€ U.	70,05	66,95	62,83	-
	Ref.	80/125	4023108	4023343	-
	€ U.	70,05	66,95	-	-
AISI	Ref.	80/130	4023110	-	4023116
304-304	€ U.	53,89	-	-	46,35



Adaptador biflujo horizontal | Horizontal biflow adapter | Adaptateur de biflow horizontal

ØDi / ØDe mm		80/125	80/130	100/150	130/200
AISI	Ref.	4040020	4040021	4040022	4040023
316L-304	€ U.	103,68	105,28	121,54	140,08
Especificaciones técnicas Technical specifications Spécifications techniques					
	ØDs	60	60	60	80
	Aire Air Air				
	Gas Gas Gaz				

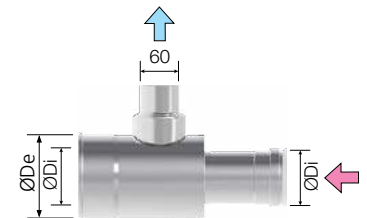

Te y tapa
T Piece and cover
Té et tampon

Te sin tapa | "T" Piece without cap | Té sans tampon 93°

ØDi / ØDe mm		80/125	80/130	100/150	130/200
AISI	Ref.	4028294	4023083	4023084	4023087
304-304	€ U.	65,78	66,77	70,18	74,51
AISI	Ref.	4028307	4028446	4028447	4028448
316L-304	€ U.	78,93	80,12	84,21	89,40
Especificaciones técnicas Technical specifications Spécifications techniques					
	L	288	288	321	358
	H	115	115	125	149
	V	144	144	161	179

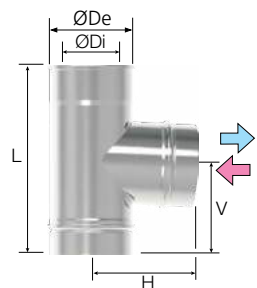

Te admisión reducida a 60 | Admission "T" Piece reduced to 60 | Té admission réduit à 60 90°

ØDi / ØDe mm		80/125	80/130	100/150	130/200
AISI	Ref.	4028295	4015481	4015793	4023091
304-304	€ U.	72,51	73,61	85,49	96,37
AISI	Ref.	4028308	4020568	4020569	4023066
316L-304	€ U.	94,26	95,71	111,24	125,27

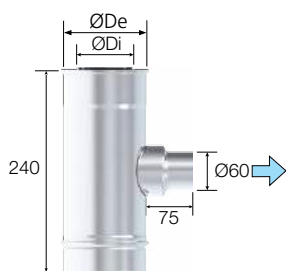

Te y tapa
"T" Piece and cover
Té et tampon

Te salida gas con tapa purga | "T" Piece gas outlet with condensate cap | Té sortie gaz avec tampon récupérateur condensats 93°



ØDi / ØDe mm		80/125	80/130	100/150	130/200
AISI 304-304	Ref.	4028296	4023093	4023094	4023095
	€ U.	116,42	118,18	124,45	130,80
AISI 316L-304	Ref.	4028309	4023067	9023068	4023069
	€ U.	151,35	153,65	161,78	170,04

Especificaciones técnicas | Technical specifications | Spécifications techniques

	L	318	318	351	368
H	156	156	166	182	
V	137	137	153	161	

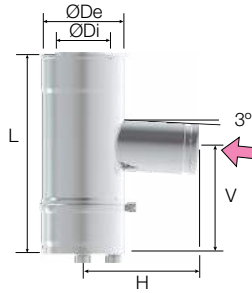

Módulo inspección | Inspection module | Module d'inspection



ØDi / ØDe mm		80/125	80/130	100/150	130/200
AISI 304-304	Ref.	4028298	4023096	4023097	4023098
	€ U.	65,78	66,77	70,18	74,51
AISI 316L-304	Ref.	4028311	4023072	4023073	4023074
	€ U.	78,93	80,12	84,21	89,40

Especificaciones técnicas | Technical specifications | Spécifications techniques

	L	288	288	321	358
--	---	-----	-----	-----	-----



Te giratoria | Rotary "T" Piece | Té rotatif

	ØDi mm	80/130		100/150	
		standard	reducido a reducido a 60	standard	reducido a reducido a 60
AISI 316L-304	Te giratoria 90° H/H corta Rotary "T" piece 90° F/F short Té rotatif 90° F/F court	Ref. 4029295	-	4029296	-
	€ U.	138,31	-	145,22	-
	Te giratoria 90° M/H corta Rotary "T" piece 90° M/F short Té rotatif 90° M/F court	Ref. 4022090	4023071	4029293	9023070
€ U.	134,82	159,65	141,56	167,63	
Te giratoria 90° M/H larga Rotary "T" piece 90° M/F long Té rotatif 90° M/F longue	Ref. 4029298	-	4029299	-	
€ U.	146,26	-	153,57	-	

Especificaciones técnicas | Technical specifications | Spécifications techniques

	C	105	135
L	320		360



Tapa
Cover
Trappe

Tapa | Cap | Tampon



ØDi / ØDe mm		80/125	80/130	100/150	130/200
AISI 304-304	Ref.	4028300	4015485	4015795	4028304
	€ U.	43,92	44,60	46,02	47,71
AISI 316L-304	Ref.	4028312	4020663	4020664	4023082
	€ U.	57,10	57,98	59,82	62,02

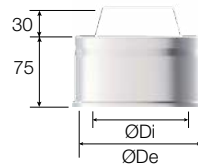

Tapa purga | Condensate cap | Tampon récupérateur condensats



ØDi / ØDe mm		80/125	80/130	100/150	130/200
AISI 304-304	Ref.	4028301	4018968	4023129	4023132
	€ U.	53,93	54,75	57,77	60,02
AISI 316L-304	Ref.	4028313	4020602	4020465	4020604
	€ U.	70,11	71,17	75,11	78,02

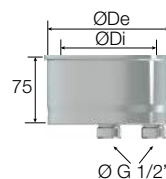

Referencia Référence	Ref.	4028296	Unidad de embalaje Packaging unit Unités par emballage
Precio unidad € Unit price, € Prix unité €	€ U.	116,42	1

Incluye juntas
Gaskets included
Joints inclus

Juntas necesarias
Required gaskets
Joints nécessaires

Base inicial tripode
Base tripod
Trépied de base

Kit base inicial tripode | Floor base tripod kit | Kit trépied plaque de départ au sol



1 Tapa condensación tripode | Tripod condensate cap | Tampon condensats trépied

ØDi / ØDe mm		80/125	80/130	100/150	130/200
AISI 316L-304	Ref.	4033305	4033306	4033307	4033309
	€ U.	56,62	58,43	61,57	64,33

2 Soporte base tripode | Base tripod support | Support au sol trépied

ØDi / ØDe mm		80/125	80/130	100/150	130/200
AISI 304	Ref.	4033310	4033310	4033453	4033455
	€ U.	50,82	50,82	52,53	54,59

Prolongación base tripode 1 m
Base tripod extension 1 m
Rallonge support au sol trépied 1 m

Ref.	4033311
€ U.	33,17

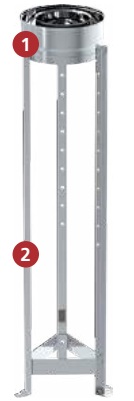

Tapa
Cover
Trappe

Tapa de inspección | Inspection cover | Trappe d'inspection 200°C / 200 Pa



ØDi / ØDe mm		80/125	80/130	100/150	130/200
AISI 304	Ref.	5003265	5003265	5003266	5003267
	€ U.	18,75	18,75	19,01	22,29



Tapa de inspección | Inspection cover | Trappe d'inspection 450°C / 40 Pa



ØDi / ØDe mm		80/125	80/130	100/150	130/200
AISI 304	Ref.	5003391	5003391	5003392	5003393
	€ U.	26,23	26,23	30,29	34,26

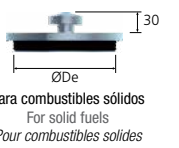

Soporte
Support
Support

Soporte mural intermedio | Intermediate wall support | Support mural intermédiaire



ØDi / ØDe mm		80/125	80/130	100/150	130/200
AISI 316L-304	Ref.	4028316	4023078	4023079	4023080
	€ U.	58,22	58,22	61,25	65,84

Especificaciones técnicas | Technical specifications | Spécifications techniques

	A	160	165	185	233
B	240	245	265	313	

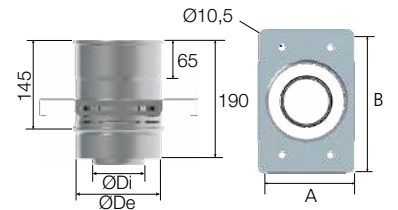

Sombrero
Cap
Chapeau

Sombrero salida vertical | Vertical exit cap | Chapeau sortie verticale



ØDi / ØDe mm		80/125	80/130	100/150	130/200
AISI 304-304	Ref.	4028303	2700518	2700557	4010094
	€ U.	102,02	103,58	106,55	118,56
AISI 316L-304	Ref.	4028314	4012950	4014585	4016746
	€ U.	126,10	128,02	131,70	146,54

Especificaciones técnicas | Technical specifications | Spécifications techniques

	ØDp	250	250	250	300
	ØDd	178	178	198	298

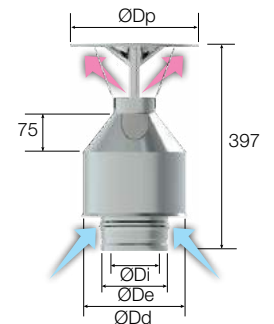

Sombrero salida horizontal | Horizontal exit cap | Chapeau sortie horizontale



ØDi / ØDe mm		80/125	80/130	100/150	130/200
AISI 304-304	Ref.	4028302	2700145	2700582	4010095
	€ U.	112,13	113,83	117,10	130,31
AISI 316L-304	Ref.	4028315	4013748	4016747	4016748
	€ U.	138,59	140,69	144,74	161,06

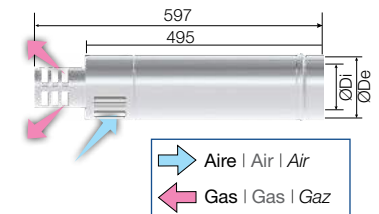

Junta
Gasket
Joint

Junta silicona | Silicone gasket | Joint silicone



ØDi / ØDe mm		80/125	80/130	100/150	130/200
Ref.	5003948	5003948	5003950	5003951	
€ U.	1,00	1,00	1,09	1,38	

**Rosetón blanco
White Rosette
Rosace blanche**



EPDM

Ref.	2700131
€ U.	7,39

Abrazadera mural exterior | External wall bracket | Collier support mural extérieur

ØDi - ØDe mm		80/125	80/130	100/150	130/200
AISI 304	Ref.	4035905	4019876	4019877	4019879
	€ U.	38,30	35,93	36,76	41,38
Especificaciones técnicas Technical specifications Spécifications techniques					
A		185	185	205	235

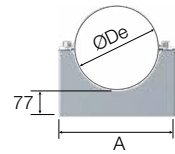

Abrazadera mural interior | Interior wall bracket | Bride murale intérieur

ØDi - ØDe mm		80/125	80/130	100/150	130/200
AISI 304	Ref.	4013902	2500038	2500039	2500041
	€ U.	9,77	10,06	10,68	12,89
Especificaciones técnicas Technical specifications Spécifications techniques					
A		150	150	150	190

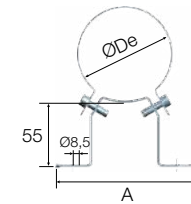

Abrazadera pared regulable | Adjustable wall bracket | Collier mural réglable

ØDi - ØDe mm		80/125	80/130	100/150	130/200
AISI 304	Ref.	4600702	4600707	4600703	4600704
	€ U.	11,75	12,12	14,04	21,15
Especificaciones técnicas Technical specifications Spécifications techniques					
A		186	186	186	226

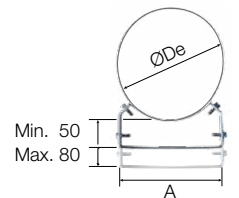

Abrazadera de unión tornillo | Connection bracket, screwed | Collier de fixation à vis

ØDi - ØDe mm		80/125	80/130	100/150	130/200
AISI 304	Ref.	5004280	5003967	5003968	5003970
	€ U.	3,32	3,38	3,49	3,73



Abrazadera de vientos | Roof brace band | Bride de haubanage

ØDi - ØDe mm		80/125	80/130	100/150	130/200
AISI 304	Ref.	4013907	2700121	2700190	2700295
	€ U.	21,47	22,08	22,98	25,81



Escuadra soporte mural (2 unidades) | Square wall support (2 units) | Équerre support mural (2 unités)



	Pequeño Small Petit	Mediano Medium Moyen	Grande Large Grand
Ref.	4019925	4019926	4019927
€ Kit	51,48	68,70	72,06
Especificaciones técnicas Technical specifications Spécifications techniques			
L	245	360	515
H	290	430	610

Escuadra con soporte mural
Square with wall support
Équerre avec support mural

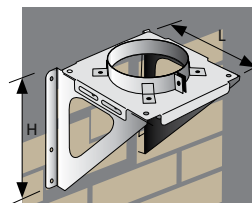

* Consultar el tamaño adecuado en la página 165.
Refer to the appropriate size on page 165.
Voir la taille appropriée à la page 165

Prolongación mural (2 unidades) | Wall extension (2 units) | Rallonge murale (2 unités)

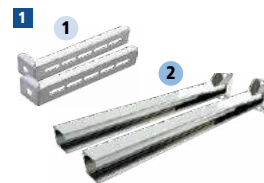

		150 mm	250 mm	500 mm	750 mm	1000 mm
AISI 304	Ref.	4019959	4019960	5004657	5004656	5004655
	€ U.	27,18	34,03	131,81	158,13	178,91

1 Para soporte mural exterior e interior
For exterior and interior wall support
Pour support mural extérieur et intérieur

Soporte mural universal | Universal wall support | Support mural universel

ØDi - ØDe mm		80/125	80/130	100/150	130/200
AISI 304	Ref.	4028317	4026049	4026050	4026052
	€ U.	57,84	58,60	62,78	74,23
Especificaciones técnicas Technical specifications Spécifications techniques					
A		263	263	283	333
B		343	343	363	413

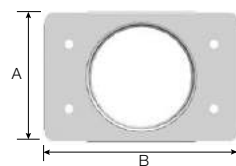

Escuadra reforzada (2 unidades) | Reinforced square (2 units) | Support renforcé (2 unités)



	L 500 mm	L 750 mm	L 1000 mm
Ref.	5003914	5003915	5003916
€ U.	141,15	173,25	215,56
Especificaciones técnicas Technical specifications Spécifications techniques			
H	310	470	600

Escuadra reforzada con soporte mural
Reinforced square with wall support
Support renforcé avec support mural

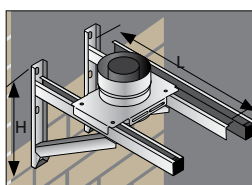

Referencia Reference Référence	Ref.	4035905	Unidad de embalaje Packaging unit Unités par emballage
Precio unidad € Unit price, € Prix unité €	€ U.	38,30	1

Incluye juntas Gasket included Joints inclus	Ø	Juntas necesarias Required gaskets Joints nécessaires	x n
--	---	---	-----

Abrazadera forjado | Ceiling bracket | Collier support plancher



ØDi - ØDe mm		80/125	80/130	100/150	130/200
AISI 304	Ref.	4028373	4022023	4022025	4011861
	€ U.	27,95	27,95	28,46	32,85

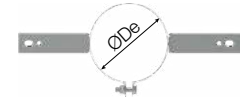

Abrazadera forjado reforzada | Reinforced ceiling bracket | Collier support plancher renforcé



ØDi - ØDe mm		80/125	80/130	100/150	130/200
AISI 304	Ref.	4028374	4026828	9023220	9023221
	€ U.	33,64	33,87	34,05	34,68

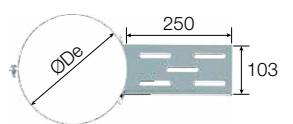

Abrazadera forjado universal | Universal ceiling bracket | Collier support plancher universel



ØDi - ØDe mm		80/125	80/130	100/150	130/200
AISI 304	Ref.	4028318	4026043	4026044	4026046
	€ U.	29,93	29,93	30,08	30,86

Fijación forjado angular (2 unidades) | Angular forged fixation (2 units) | Fixation angulaire (2 unités)



1000 mm	
Ref.	4026057
€ U.	31,62

Kit prolongación forjado | Forged extension kit | kit extension étage



ØDe mm		130	150	180	200
AISI 304	Ref.	4026038		4026042	
	€ U.	52,67		73,73	

Consultar las diferentes opciones de soporte en la página 165 | For support options, see page 165 | Pour les options d'assistance, voir page 165.

Kit fijación reforzado universal (2 unidades) | Universal reinforced fastening kit (2 units) | Kit fixation renforcé universel (2 unités)



1000 mm	
Ref.	4026055
€ U.	45,54

Kit fijación soporte mural universal
Universal wall support kit
Kit support mural universel

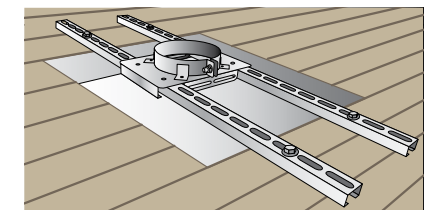

Distanciador fuego ventilado | Ventilated firebreak | Plaque écart au feu ventilée



ØDi - ØDe mm		80/125	80/130	100/150	130/200
AISI 304	Ref.	4016782	4016783	4016784	4016786
	€ U.	50,99	51,64	54,50	61,14

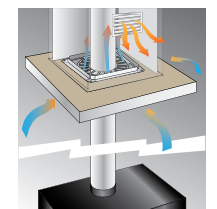

Distanciador fuego | Firebreak | Plaque écart au feu



ØDi - ØDe mm		80/125	80/130	100/150	130/200
AISI 304	Ref.	4019114	4018288	4019115	4018698
	€ U.	38,74	39,64	41,20	46,35

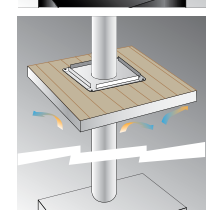

13 CCc

Conducto Concéntrico Colectivo
Collective Concentric Piping
Conduit Concentrique Collectif

Ø100/150 - 250/400

DTA
DOCUMENT
TECHNIQUE
D'APPLICATION
3CEp
Núm. 14.2/15-2103_V1



1 Sombrero: antilluvia
Cap: rain cap
Chapeau: pare-pluie

2 Collarín
Storm collar
Collerette

3 Cubreaguas 5°-25°, 25°-45°, 45°-60° y cubreaguas inox. horizontal
Roof flashing 5°-25°, 25°-45°, 45°-60° and horizontal SS roof flashing
Solin toit 5°-25°, 25°-45°, 45°-60° et solin inox. horizontal

4 Módulo lineal 1.000 mm, 500 mm, 250 mm,
módulo extensible 335-565 mm, 500-900 mm, 750-1.350 mm
Linear module 1.000 mm, 500 mm, 250 mm,
extendable module 335-565 mm, 500-900 mm, 750-1.350 mm
Élément droit 1.000 mm, 500 mm, 250 mm
élément télescopique 335-565, 500-900, 750-1.350

5 Te 90° reducida a Ø80-125/130, módulos de 500 mm y 1.000 mm
"T" piece 90° reduced to Ø80-125/130, 500 mm and 1.000 mm modules
Té 90° réduit à Ø80-125/130, éléments de 500 mm et 1.000 mm

6 Abrazadera mural interior y abrazadera forjado reforzada
Interior wall bracket and adjustable interior wall bracket
Bride murale intérieur et bride murale intérieure réglable

7 Elementos de conexión a la caldera
Elements for boiler connecting
Éléments de raccordement au chaudière

8 Soporte mural intermedio y escuadras reforzadas
Intermediate wall support and reinforced squares
Support mural intermédiaire et équerres renforcés

9 Tapa purga
Drain cap
Tampon purge

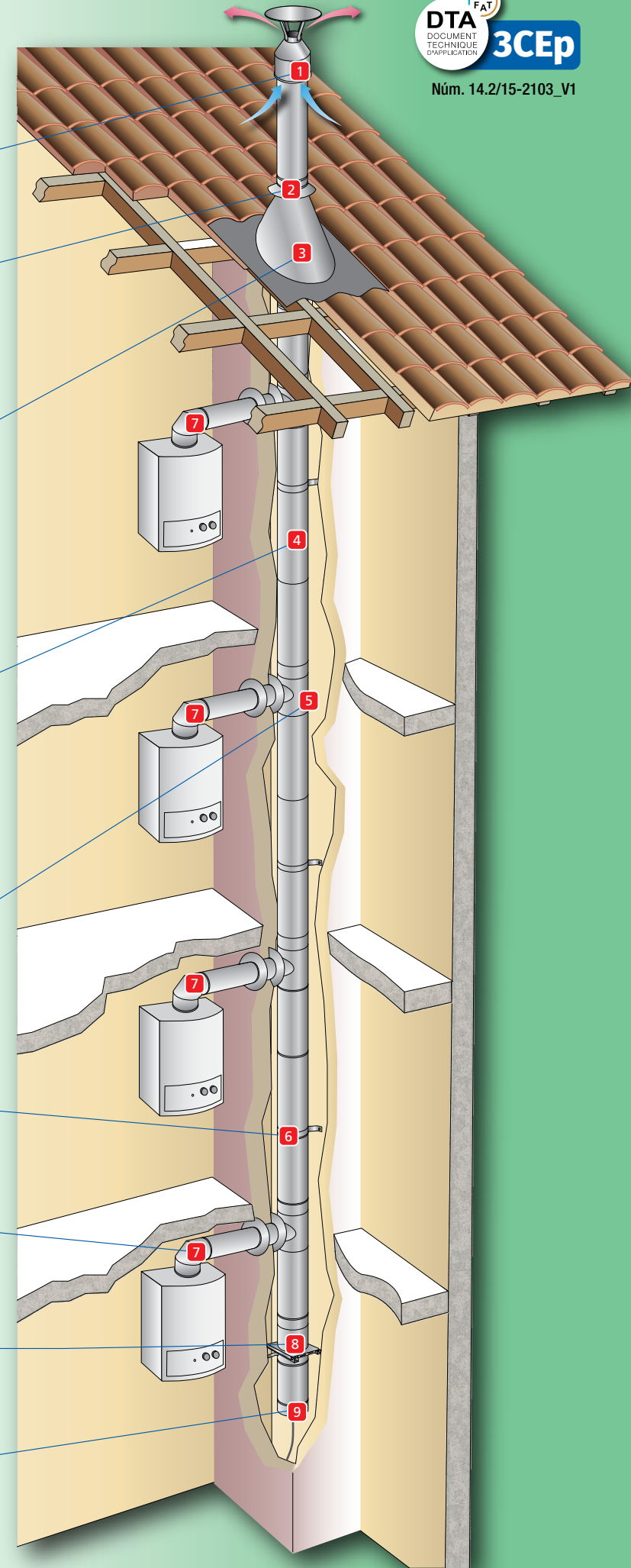

CE Especificaciones de acuerdo a la legislación europea en productos de construcción CPR
Specifications according to EU product regulations of construction CPR
Spécifications Selon la réglementation européenne concernant les produits de construction CPR

interior | inside | intérieur
exterior | outside | extérieur

AISI 316L
(1.4404) 2R

AISI 304
(1.4301) 2R

EN 1856-1

Ø100/150
-250/400

T200 P1 W V2 L50040 O(20)*
T200 N1 W V2 L50040 O(20)

* Para cumplir con esta designación todos los elementos deben estar instalados con juntas, consulte la página 138. Para saber el número de juntas, consulte la página 165.

* To comply with this designation, all elements must be installed with gaskets, see page 138. For the number of joints, see page 165.

* Pour respecter cette désignation, tous les éléments doivent être installés avec des joints, voir page 138. Unités de joints par élément, voir page 165.

Para el resto de elementos, la junta es opcional.
For all other elements, the gasket is optional.
Pour tous les autres éléments, le joint est optionnel.

Módulo lineal y extensible
Linear and extendable module
Élément droit et télescopique

Módulo lineal | Linear module | Élément droit

ØDi / ØDe mm **100/150 110/180 130/200 150/250 180/300 200/350 250/400**

L 1000 mm

AISI	Ref.	4014581	4031460	4016735	4023114	4023119	4023126	4023131
316L-304	€ U.	97,38	119,89	141,50	155,58	200,10	246,33	273,42

L 500 mm

AISI	Ref.	4014593	4031459	4016738	4023115	4023120	4023128	4023133
316L-304	€ U.	80,34	88,89	108,15	109,44	140,76	173,28	192,32

L 250 mm

AISI	Ref.	4016739	4031458	4016740	4023117	4023124	4023130	4023135
316L-304	€ U.	61,80	70,04	87,55	89,13	114,62	141,09	156,61

Módulo extensible | Extendable module | Élément télescopique

ØDi / ØDe mm **100/150 110/180 130/200 150/250 180/300 200/350 250/400**

Lmin 750 mm - Lmax 1350 mm

AISI	Ref.	4028366	4031436	4028367	4028368	4028369	4028370	4028371
316L-304	€ U.	156,15	168,47	178,81	217,99	264,56	318,49	337,54

Lmin 500 mm - Lmax 900 mm

AISI	Ref.	9023076	9031421	9023077	9023111	4023113	4023118	4023121
316L-304	€ U.	128,89	140,52	157,97	190,74	237,26	282,18	302,22

Lmin 335 mm - Lmax 565 mm

AISI	Ref.	4014592	9031420	4016741	4023134	9023138	4023139	4023140
316L-304	€ U.	115,08	125,46	141,04	184,48	229,23	272,28	288,48

Codo
Elbow
Coude

Codo | Elbow | Coude 30°

ØDi / ØDe mm **100/150 110/180 130/200 150/250 180/300 200/350 250/400**

AISI	Ref.	4023089	4031416	4023090	4023147	4023148	4023150	4023151
316L-304	€ U.	64,00	74,16	82,40	94,25	118,45	145,23	162,74

Especificaciones técnicas | Technical specifications | Spécifications techniques

	H	11	11	11	11	11	11	11
	V	123	126	130	130	126	130	130

Codo | Elbow | Coude 45°

ØDi / ØDe mm **100/150 110/180 130/200 150/250 180/300 200/350 250/400**

AISI	Ref.	4014583	4031417	4016744	4023153	4023154	4023156	4023158
316L-304	€ U.	66,36	75,80	82,73	96,93	120,65	148,52	164,85

Especificaciones técnicas | Technical specifications | Spécifications techniques

	H	11	11	11	11	11	11	11
	V	123	126	130	130	126	130	130

Adaptador
Adapter
Adaptateur

Adaptadores conector aumento | Augmentation connection adapters | Adaptateurs raccord augmentation

ØDi / ØDe mm **60/100 80/110 80/125**

AISI	Ref.	Ø 80-125	4023108	4023343	-
316L-304	€ U.	Ø 80-125	70,05	66,95	-
	Ref.	Ø 80-130	4023109	4023344	4012949
	€ U.	Ø 80-130	70,05	66,95	62,83

Te
"T" Piece
Té

Te reducida a | "T" Piece reduced to | Té réduit à 60/100 333 mm 93°

ØDi / ØDe mm **100/150 110/180 130/200 150/250 180/300 200/350 250/400**

AISI	Ref.	4020464	4031447	4020416	4028382	4021580	4028383	4028384
316L-304	€ U.	118,83	128,02	140,03	153,76	181,36	218,45	231,59

Referencia
Reference
Référence

Ref.	4023114
Unidad de embalaje Packaging unit Unités par emballage	1

Precio unidad €
Unit price, €
Prix unité €

€ U.	155,58
1	1

Incluye juntas
Gaskets included
Joints inclus

Juntas necesarias
Required gaskets
Joints nécessaires

x1

Te y tapa
"T" Piece and cover
Té et tampon

Te reducida | "T" Piece reduced | Té réduit 500 mm 93°

ØDi / ØDe mm **100/150 110/180 130/200 150/250 180/300 200/350 250/400**

REDUCIDA A | REDUCED TO | RÉDUIT À **80/130**

AISI	Ref.	4022397	4031449	4023175	4023179	4023180	4023191	4023192
316L-304	€ U.	129,78	140,08	153,47	168,92	198,79	238,96	254,41

Te reducida | "T" Piece reduced | Té réduit 1.000 mm 93°

ØDi / ØDe mm **100/150 110/180 130/200 150/250 180/300 200/350 250/400**

REDUCIDA A | REDUCED TO | RÉDUIT À **80/130**

AISI	Ref.	4023205	4031457	4023206	4023207	4023208	4023209	4023211
316L-304	€ U.	162,74	174,07	191,82	207,85	247,20	296,64	316,21

Conducto de conexión | Connection piping | Conduit de raccordement RAL 9016

ØDi / ØDe mm **80/130**

Ref.	4026068
€ U.	68,65

Reducción | Reduction adapter | Réduction

ØDi / ØDe mm **80/130 - 80/125**

AISI	Ref.	4019106
316L-304	€ U.	62,35

1 Apto sólo para Ø80/130 | Suitable only for Ø80/130 | Convient seulement pour Ø80/130

Tapa
Cover
Trappe

Tapa purga | Condensate cap | Tampon récupérateur condensats

ØDi / ØDe mm **100/150 110/180 130/200 150/250 180/300 200/350 250/400**

AISI	Ref.	4020465	4031445	4020604	4023248	4023249	4023251	4023252
316L-304	€ U.	75,11	76,27	78,02	85,43	93,16	100,95	117,11

Especificaciones técnicas | Technical specifications | Spécifications techniques

ØG	1/2"	1/2"	1/2"	1/2"	3/4"	3/4"	3/4"
----	------	------	------	------	------	------	------

Base inicial trípode
Base tripod
Trépied de base

Kit base inicial trípode | Floor base tripod kit | Kit trépied plaque de départ au sol

1 Tapa condensación trípode | Tripod condensate cap | Tampon condensats trépied

ØDi / ØDe mm **100/150 110/180 130/200**

AISI	Ref.	4033307	4033308	4033309
316L-304	€ U.	61,57	63,42	64,33

2 Soporte base trípode | Base tripod support | Support au sol trépied

ØDi / ØDe mm **100/150 110/180 130/200**

AISI	Ref.	4033453	4033454	4033455
304	€ U.	52,53	53,41	54,59

Prolongación base trípode 1 m
Base tripod extension 1 m
Rallonge support au sol trépied 1 m

Ref.	4033311
€ U.	33,17

Soporte
Support
Support

Soporte mural intermedio | Intermediate wall support | Support mural intermédiaire

ØDi / ØDe mm **100/150 110/180 130/200 150/250 180/300 200/350 250/400**

AISI	Ref.	4023079	4031444	4023080	4023213	4023214	4023269	4023274
316L-304	€ U.	61,25	63,09	65,84	82,65	96,13	107,95	125,68

Especificaciones técnicas | Technical specifications | Spécifications techniques

A	160	165	185	233	333	383	433
B	240	245	265	313	413	463	513

fabricado en: | made of: | fabriquée en: **AISI 304 & AISI 316L 2R** (Brillante | Bright | Brillant)

Sombrero
Cap
Chapeau

Sombrero salida vertical | Vertical exit cap | Chapeau sortie verticale



ØDi / ØDe mm		100/150	110/180	130/200	150/250	180/300	200/350	250/400
AISI 316L-304	Ref.	4014585	4031442	4016746	4028377	4028378	4028379	4028380
	€ U.	131,70	140,08	146,54	165,83	184,37	202,91	227,63
Especificaciones técnicas Technical specifications Spécifications techniques								
	ØDp	250	250	250	300	350	400	500
	ØDd	180	180	200	300	400	500	550



Junta
Gasket
Joint

Junta silicona | Silicone gasket | Joint silicone



ØDi / ØDe mm		100/150	110/180	130/200	150/250	180/300	200/350	250/400
	Ref.	5003950	5004278	5003951	5003952	5003953	5003954	5003957
	€ U.	1,09	1,33	1,38	1,83	2,68	2,99	4,01

Abrazadera
Bracket
Bride, Collier

Abrazadera mural interior | Interior wall bracket | Bride murale intérieur



ØDi-ØDe mm		100/150	110/180	130/200	150/250	180/300	200/350	250/400
AISI 304	Ref.	2500039	2500040	2500041	2500042	2500043	2500510	2500044
	€ U.	10,68	11,54	12,89	18,69	24,04	32,91	46,55
Especificaciones técnicas Technical specifications Spécifications techniques								
	L	150	160	190	230	230	300	300

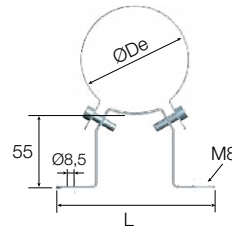

Abrazadera pared regulable | Adjustable wall bracket | Collier mural réglable



ØDi-ØDe mm		100/150	110/180	130/200	150/250	180/300	200/350	250/400
AISI 304	Ref.	4600703	4600705	4600704	4600706	4600709	4600710	4600711
	€ U.	14,04	17,31	21,15	27,88	33,65	41,35	53,71
Especificaciones técnicas Technical specifications Spécifications techniques								
	L	186	196	226	266	266	336	336

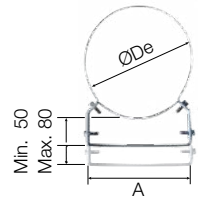

Abrazadera de vientos | Roof brace band | Collier pour haubanage



ØDi-ØDe mm		100/150	110/180	130/200	150/250	180/300	200/350	250/400
AISI 304	Ref.	2700190	2700241	2700295	2700354	2700403	2700323	2700418
	€ U.	22,98	24,92	25,81	30,46	38,86	52,95	60,52

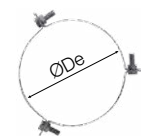

Abrazadera de unión tornillo | Connection bracket, screwed | Collier de fixation à vis



ØDi-ØDe mm		100/150	110/180	130/200	150/250	180/300	200/350	250/400
AISI 304	Ref.	5003968	5003969	5003970	5003972	5003973	5003974	5003975
	€ U.	3,49	3,62	3,73	3,98	4,34	4,82	5,30

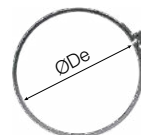

Prolongación mural (2 unidades) | Wall extension (2 units) | Rallonge murale (2 unités)



ØDi-ØDe mm		150 mm	250 mm	500 mm	750 mm	1000 mm
AISI 304	Ref.	4019959	4019960	5004657	5004656	5004655
	€ U.	27,18	34,03	131,81	158,13	178,91

1 Para soporte mural exterior e interior
For exterior and interior wall support
Pour support mural extérieur et intérieur

Escuadra soporte mural (2 unidades) | Square wall support (2 units) | Équerre support mural (2 unités)



	Pequeño Small Petit	Mediano Medium Moyen	Grande Large Grand
Ref.	4019925	4019926	4019927
€ Kit	51,48	68,70	72,06
Especificaciones técnicas Technical specifications Spécifications techniques			
L	245	360	515
H	290	430	610

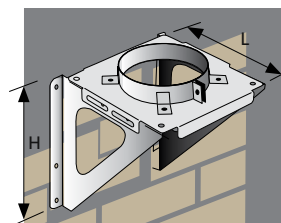

Escuadra con soporte mural
Square with wall support
Équerre avec support mural

* Consultar el tamaño adecuado en la página 165.
Refer to the appropriate size on page 165.
Voir la taille appropriée à la page 165

Referencia Référence	Ref.	4028377	Unidad de embalaje Packaging unit Unités par emballage
Precio unidad € Unit price, € Prix unité €	€ U.	165,83	1

Incluye juntas
Gaskets included
Joints inclus

Juntas necesarias
Required gaskets
Joints nécessaires

x n

Abrazadera
Bracket
Bride, Collier

Soporte mural universal | Universal wall support | Support mural universel



ØDi-ØDe mm		100/150	110/180	130/200	150/250	180/300	200/350	250/400
AISI 304	Ref.	4026050	4026051	4026052	4026054	4026059	4026060	4026061
	€ U.	62,78	68,36	74,23	86,98	106,37	123,23	138,23
Especificaciones técnicas Technical specifications Spécifications techniques								
	A	180	180	180	180	214	248	298
	B	260	260	260	260	294	328	378

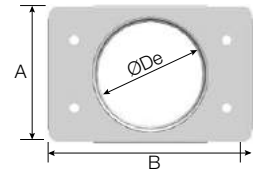

Escuadra reforzada (2 unidades) | Reinforced square (2 units) | Support renforcé (2 unités)



L		500 mm	750 mm	1000 mm
Ref.		5003914	5003915	5003916
€ U.		141,15	173,25	215,56
Espec. técnicas Technical specif. Spécif. techniques				
	H	310	470	600

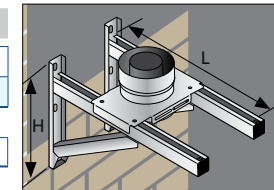

Escuadra reforzada con soporte mural
Reinforced square with wall support
Support renforcé avec support mural

Kit fijación reforzado universal (2 unidades)

Universal reinforced fastening kit (2 units)

Kit fixation renforcé universel (2 unités)



1000 mm	
Ref.	4026055
€ U.	45,54

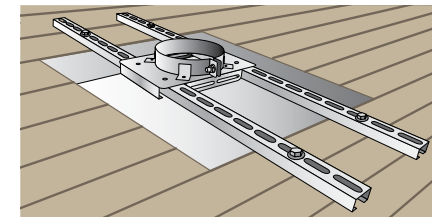

Kit fijación soporte mural universal
Universal wall support kit
Kit support mural universel

Abrazadera forjado | Ceiling bracket | Collier support plancher



ØDi-ØDe mm		100/150	110/180	130/200	150/250	180/300	200/350	250/400
AISI 304	Ref.	4022025	4022027	4011861	5001471	5001456	5001472	5001473
	€ U.	28,46	30,46	32,85	36,82	52,02	53,98	56,62

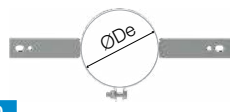

Abrazadera forjado reforzada | Reinforced ceiling bracket | Collier support plancher renforcé



ØDi-ØDe mm		100/150	110/180	130/200	150/250	180/300	200/350	250/400
AISI 304	Ref.	9023220	4026934	9023221	4023222	4023223	4023224	4023225
	€ U.	34,05	34,23	34,68	35,62	38,84	39,83	41,27
Especificaciones técnicas Technical specifications Spécifications techniques								
	A	103	103	103	103	138	138	138
	B	250	250	250	250	300	300	300

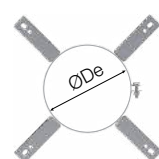

Soporte de montaje universal
Universal mounting support
Support fixation universel

Abrazadera forjado universal | Universal ceiling bracket | Collier support plancher universel



ØDi-ØDe mm		100/150	130/200	150/250	180/300	200/350	250/400
AISI 304	Ref.	4026044	4026046	4026048	4026080	4026081	4026082
	€ U.	30,08	30,86	32,11	36,21	44,68	51,43

Fijación forjado angular (2 unidades) | Angular forged fixation (2 units) | Fixation angulaire (2 unités)



1000 mm	
Ref.	4026057
€ U.	31,62

Consultar las diferentes opciones de soporte en la página 165 | For support options, see page 165 | Pour les options d'assistance, voir page 165.

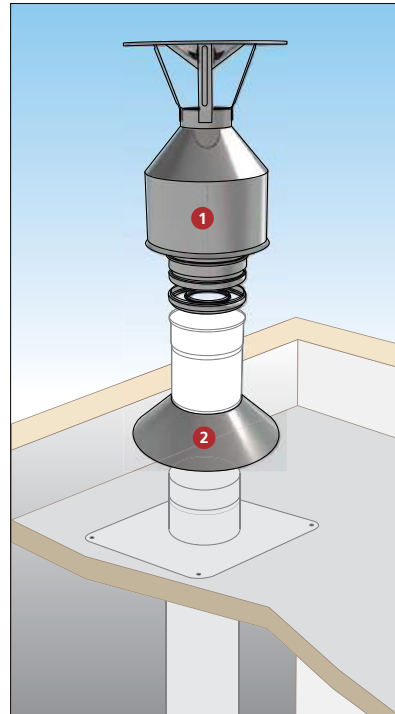

Kit terminal
End-piece kit
Kit finition

El kit incluye los siguientes elementos: | The kit includes: | *Le kit comprend les éléments suivants:*

- 1** Sombrero salida vertical + junta
Vertical termination + gasket
Chapeau sortie verticale + joint
- | |
|-------------|
| Ø 80 - 130 |
| Ø 100 - 150 |
| Ø 110 - 180 |
| Ø 130 - 200 |
- +** Juntas | Gaskets | *Joints*
- | |
|---------------------------|
| Ø 80 - 130 |
| Ø 100 - 150 / Ø 110 - 180 |
| Ø 130 - 200 |



ØD	Referencia Reference Référence	Precio Price Prix
80 - 130	4035393	153,63 €
100 - 150	4035394	158,04 €
110 - 180	4035395	168,10 €
130 - 200	4035396	175,85 €

- 2** Collarín | Storm collar | *Collerette 75 mm*
- | |
|-------------|
| Ø 80 - 130 |
| Ø 100 - 150 |
| Ø 110 - 180 |
| Ø 130 - 200 |
-

Puede encontrar estos módulos en las secciones concéntricas de esta tarifa.
You can find these modules in the concentric sections of this price list.
Vous pouvez trouver ces modules dans les sections concentriques de ce tarif.

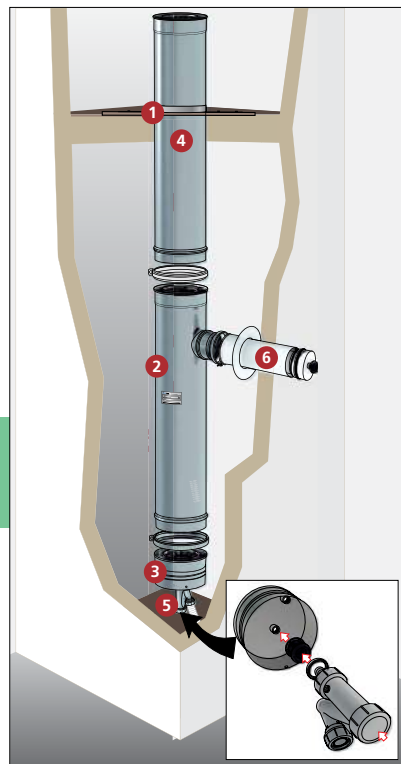

Kit base
Base kit
Kit départ au sol

El kit incluye los siguientes elementos: | The kit includes: | *Le kit comprend les éléments suivants:*

- 1** Abrazadera forjado
Ceiling bracket | *Collier support plancher*
- | |
|-------------|
| Ø 80 - 130 |
| Ø 100 - 150 |
| Ø 110 - 180 |
| Ø 130 - 200 |
- 3** Tapa condensación
Condensate cap
Tampon récupérateur condensats
- | |
|-------------|
| Ø 80 - 130 |
| Ø 100 - 150 |
| Ø 110 - 180 |
| Ø 130 - 200 |
- 5** Kit sifón | Siphon kit | *Kit siphone 1/2"*
- | |
|------------|
| Ø 80 - 200 |
|------------|
- 6** Conducto de conexión | *Conexion conduit | Conduit de liaison*
- | |
|-------------------|
| Ø 80/125 - 80/130 |
| Ø 80 - 130 |
- +** Juntas | Gaskets | *Joints*
- | |
|---------------------------|
| Ø 80 - 130 |
| Ø 100 - 150 / Ø 110 - 180 |
| Ø 130 - 200 |

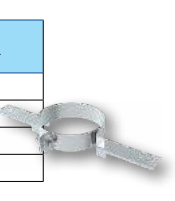

ØD	Referencia Reference Référence	Precio Price Prix
80 - 130	4035385	350,20 €
100 - 150	4035386	362,26 €
110 - 180	4035387	387,90 €
130 - 200	4035388	421,59 €

- 2** Te 93° reducido a Ø80/130+2 juntas
"T" Piece 93° reduced to Ø80/130+2 gaskets
Té 93° réduit à Ø80/130+2 joints
- | |
|-------------|
| Ø 80 - 130 |
| Ø 100 - 150 |
| Ø 110 - 180 |
| Ø 130 - 200 |

- 4** Módulo lineal | Linear module | *Élément droit*
- | |
|--|
| 1000 mm+Juntas Gaskets <i>Joints</i> |
| Ø 80 - 130 |
| Ø 100 - 150 |
| Ø 110 - 180 |
| Ø 130 - 200 |

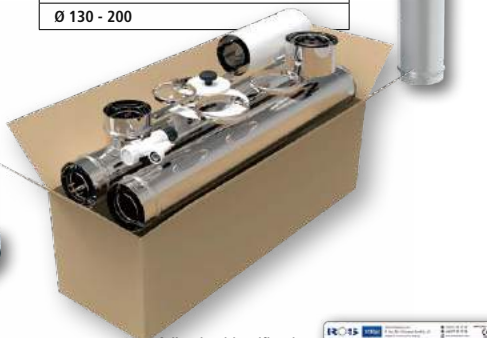

Puede encontrar estos módulos en las secciones concéntricas de esta tarifa.
You can find these modules in the concentric sections of this price list.
Vous pouvez trouver ces modules dans les sections concentriques de ce tarif.

Adhesivo identificativo
Identifying adhesive label
Étiquette d'identification
3CEP - REF. 4033302



Kit forjado
Ceiling kit
Kit plancher

El kit incluye los siguientes elementos: | The kit includes: | *Le kit comprend les éléments suivants:*

- 1** Abrazadera forjado
Ceiling bracket | *Collier support plancher*
- | |
|-------------|
| Ø 80 - 130 |
| Ø 100 - 150 |
| Ø 110 - 180 |
| Ø 130 - 200 |
- 3** Conducto de conexión | *Conexion conduit | Conduit de liaison*
- | |
|-------------------|
| Ø 80/125 - 80/130 |
|-------------------|
- 5** Módulo lineal 1000 mm + juntas
Linear module 1000 mm + gaskets
Élément droit 1000 mm + joints
- | |
|-------------|
| Ø 80 - 130 |
| Ø 100 - 150 |
| Ø 110 - 180 |
| Ø 130 - 200 |
- +** Juntas | Gaskets | *Joints*
- | |
|---------------------------|
| Ø 80 - 130 |
| Ø 100 - 150 / Ø 110 - 180 |
| Ø 130 - 200 |

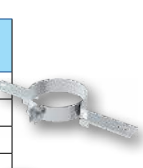

- 2** Te 93° reducido a Ø80/130 + 2 juntas
"T" Piece 93° reduced to Ø80/130 + 2 gaskets
Té 93° réduit à Ø80/130 + 2 joints
- | |
|-------------|
| Ø 80 - 130 |
| Ø 100 - 150 |
| Ø 110 - 180 |
| Ø 130 - 200 |



- 4** Módulo extensible | Extendable element
Élément télescopique 750-1350 + 2 joints
- | |
|-------------|
| Ø 80 - 130 |
| Ø 100 - 150 |
| Ø 110 - 180 |
| Ø 130 - 200 |



Adhesivo identificativo
Identifying adhesive label
Étiquette d'identification
3CEP - REF. 4033302



Puede encontrar estos módulos en las secciones concéntricas de esta tarifa.
You can find these modules in the concentric sections of this price list.
Vous pouvez trouver ces modules dans les sections concentriques de ce tarif.

Kit pasante
Bushing kit
Kit borgne

El kit incluye los siguientes elementos: | The kit includes: | *Le kit comprend les éléments suivants:*

- 1** Abrazadera forjado
Ceiling bracket | *Collier support plancher*
- | |
|-------------|
| Ø 80 - 130 |
| Ø 100 - 150 |
| Ø 110 - 180 |
| Ø 130 - 200 |
- 3** Módulo extensible | Extendable element
Élément télescopique 750-1350+2 joints
- | |
|-------------|
| Ø 80 - 130 |
| Ø 100 - 150 |
| Ø 110 - 180 |
| Ø 130 - 200 |
- +** Juntas | Gaskets | *Joints*
- | |
|---------------------------|
| Ø 80 - 130 |
| Ø 100 - 150 / Ø 110 - 180 |
| Ø 130 - 200 |

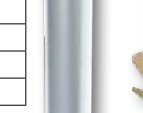
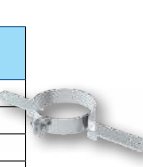

- 2** Módulo lineal | Linear module | *Élément droit*
- | |
|--|
| 1000 mm+2x2 juntas gaskets <i>joints</i> |
| Ø 80 - 130 |
| Ø 100 - 150 |
| Ø 110 - 180 |
| Ø 130 - 200 |
- 2 unidades | units | *unités*



Puede encontrar estos módulos en las secciones concéntricas de esta tarifa.
You can find these modules in the concentric sections of this price list.
Vous pouvez trouver ces modules dans les sections concentriques de ce tarif.

Puede encontrar estos módulos en las secciones concéntricas de esta tarifa.
You can find these modules in the concentric sections of this price list.
Vous pouvez trouver ces modules dans les sections concentriques de ce tarif.

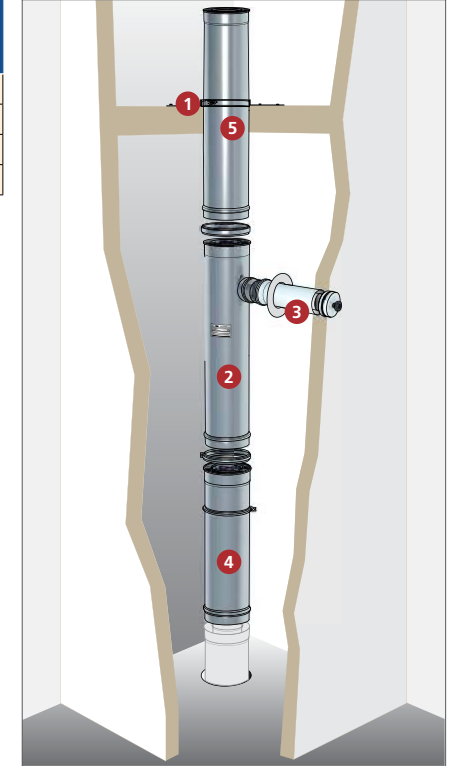

14 BD

Bajante de Descarga
Refuse Chute
Conduit de chute

Ø450 - 600

CTE
CÓDIGO TÉCNICO
DE LA EDIFICACIÓN
DB HS2

Especificaciones de acuerdo al
Código Técnico de la Edificación CTE
Specifications in accordance with
Technical Building Code CTE
Spécifications selon la norme
Code Technique du Bâtiment CTE

El **DB HS2** "Recogida y evacuación de residuos", establece como exigencia básica que los edificios dispongan de espacios y medios para extraer los residuos generados por ellos en consonancia con el sistema público de recogida facilitando la adecuada separación en origen de dichos residuos para su posterior gestión.

Este sistema de bajante de descarga, destinado a la recogida y evacuación de materiales diversos embolsados, permite la recogida de bolsas de ropa sucia o basura en hospitales, hoteles, comunidades, centros comerciales, etc. Cumple con las especificaciones descritas en el documento básico del código de la edificación **DB HS2** sobre salubridad en la recogida y evacuación de residuos.

The **DB HS2** standard "Collection and disposal of waste", establishes the basic requirement that buildings have spaces and means to extract the waste generated by them in line with the public collection system, providing adequate separation at source of waste for subsequent management.

This refuse chute system, for the collection and removal of different types of bagged materials, can be used to collect bags of dirty laundry or refuse in hospitals, hotels, communities, shopping centres, etc. It complies with the specifications described in the basic document of the **DB HS2** building code on health and safety in waste collection and disposal.

La norma **DB HS2** "Collecte et élimination des déchets", établit l'exigence de base selon laquelle les bâtiments doivent disposer d'espaces et de moyens pour extraire les déchets qu'ils génèrent, conformément au système de collecte public, en assurant une séparation adéquate à la source des déchets en vue d'une gestion ultérieure.

Ce système de conduit de chute vide-ordures/vide-linge, pour la collecte et l'élimination de matériaux divers en sacs, permet la collecte de sacs de linge sale ou d'ordures dans les hôpitaux, les hôtels, les copropriétés, les centres commerciaux, etc. Il est conforme aux spécifications décrites dans le document de base du code du bâtiment **DB HS2** sur la salubrité dans la collecte et l'élimination des déchets.



Módulo lineal y extensible
Linear and extendable module
Élément droit et télescopique

Módulo lineal | Linear module | Élément droit



ØD mm	450	500	550	600
-------	-----	-----	-----	-----

L 1000 mm

AISI 304	Ref.	4029576	4029699	4029850	4030039
€ U.		110,70	136,33	168,10	202,95

AISI 316L	Ref.	4028610	4029746	4029926	4030065
€ U.		146,58	179,38	224,48	274,70

L 500mm

AISI 304	Ref.	4029578	4029701	4029852	4030041
€ U.		67,41	83,03	102,38	123,60

AISI 316L	Ref.	4029645	4029748	4029928	4030067
€ U.		89,61	111,24	136,99	166,86

L 250 mm

AISI 304	Ref.	4029577	4029700	4029851	4030040
€ U.		54,30	66,86	82,45	99,54

AISI 316L	Ref.	4029644	4029747	4029927	4030066
€ U.		72,62	88,58	110,21	132,87

Módulo extensible | Extendable module | Élément télescopique



ØD mm	450	500	550	600
-------	-----	-----	-----	-----

Lmin 500 mm - Lmax 900 mm

AISI 304	Ref.	4029565	4029684	4029825	4030026
€ U.		199,82	239,99	290,46	334,75

AISI 316L	Ref.	4029628	4029732	4029899	4030050
€ U.		266,77	314,15	372,86	419,21

Lmin 335 mm - Lmax 565 mm

AISI 304	Ref.	4029564	4029683	4029824	4030025
€ U.		142,14	170,98	207,03	237,93

AISI 316L	Ref.	4029627	4029724	4029898	4030049
€ U.		185,40	220,42	263,68	296,64

Lmin 200 mm - Lmax 300 mm

AISI 304	Ref.	4032467	4032468	4032469	4032470
€ U.		99,91	119,48	146,26	169,95

AISI 316L	Ref.	4032472	4032473	4032474	4032475
€ U.		129,78	154,50	187,46	215,27

Codo
Elbow
Coude

Codo | Elbow | Coude 15°



ØD mm	450	500	550	600	
AISI 304	Ref.	4029559	4029679	4029818	4030016
€ U.		101,85	126,10	155,20	189,15
AISI 316L	Ref.	4029617	4029719	4029868	4030045
€ U.		127,07	156,17	194,00	235,71

Especificaciones técnicas Technical specifications Spécifications techniques				
H	43	44	45	46
V	282	288	295	301

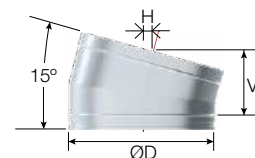

Te y tapa
"T" Piece and cover
Té et tampon

Te bajante | Downpiping "T" Piece | Té pour conduit de descente 90°



ØD mm	450	500	550	600	
AISI 304	Ref.	4040170	4040171	4040172	4040173
€ U.		230,72	275,01	334,75	392,43
AISI 316L	Ref.	4040184	4040185	4040186	4040187
€ U.		272,95	326,51	385,22	452,17

Especificaciones técnicas Technical specifications Spécifications techniques				
L	660	710	760	810
H	295	320	345	370
V	331	356	381	406

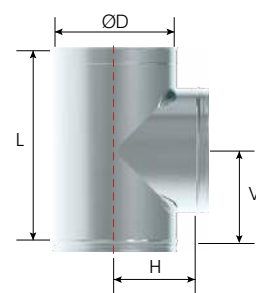

Referencia	Ref.	4029699	Unidad de embalaje
Reference			Packaging unit
Référence			Unités par emballage
Precio unidad €	€ U.	136,33	1
Unit price, €			
Prix unité €			

Reducción
Reduction adapter
Réduction

Reducción | Reduction adapter | Réduction



ØD mm	450	500	550	600	
AISI 304	Ref.	4040217	4040218	4040219	4040220
€ U.		107,06	131,98	164,21	198,02
AISI 316L	Ref.	4040221	4040222	4040223	4040224
€ U.		130,79	161,03	200,35	241,59

Especificaciones técnicas Technical specifications Spécifications techniques				
H	315	340	365	390



Sombrero
Cap
Chapeau

Sombrero antiretorno | Non-return cap | Chapeau anti-refoulement



ØD mm	200	
AISI 304	Ref.	2700310
€ U.		84,24
AISI 316L	Ref.	4016443
€ U.		117,94



Abrazadera
Bracket
Bride, Collier

Abrazadera mural interior | Internal wall band | Bride murale intérieure



ØD mm	450	500	550	600	
AISI 304	Ref.	4035019	4035066	4035067	4035068
€ U.		61,43	71,07	81,86	91,57

Especificaciones técnicas Technical specifications Spécifications techniques				
A	503	553	603	653
B	276	301	326	351

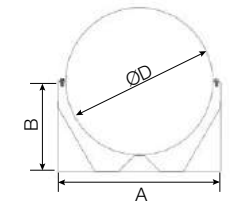

Abrazadera forjado reforzada | Reinforced ceiling bracket | Collier étage renforcé



ØD mm	450	500	550	600	
AISI 304	Ref.	4023226	4026831	4026832	4026833
€ U.		44,29	45,66	48,65	54,14

Especificaciones técnicas Technical specifications Spécifications techniques				
A	138	173	173	173
B	300	350	350	350

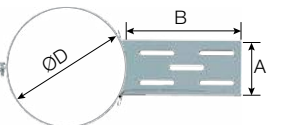

Abrazadera de unión tornillo | Connection bracket, screwed | Collier de fixation à vis



ØD mm	450	500	550	600	
AISI 304	Ref.	5004828	5004829	5004830	5004831
€ U.		12,56	14,23	16,06	17,86

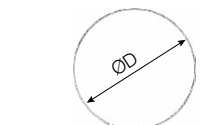

Junta
Gasket
Joint

Junta silicona | Silicone gasket | Joint silicone



ØD mm	450	500	550	600	
Ref.		5005716	5005717	5005718	5005719
€ U.		11,85	14,21	16,48	19,06

Puerta y adaptador
Door and adapter
Trappe et adaptateur

Puerta y Adaptador a puerta bajante | Door and downpiping door adapter | Trappe et adaptateur à trappe



EI₂60

Acabados y tarifa de precios, consulte al Departamento Comercial.
Finishes and price list on request, consult Sales Department.
Finitions et tarifs sur demande, consultez le Service Commercial.



15 CF

Conducto Flexible
Flexible Piping
Conduit Flexible

Ø80 - 300



1 Sombreros: antilluvia, antiretorno y salida libre
Caps: rain cap, antireturn cap and outlet cone
Chapeaux: para-pluie, anti-refouleur et cône de finition

2 Abrazadera terminal, terminal obra sin ventilar
Support band, unventilated terminal
Collier haut de tubage, solin toit plat non ventilé

3 Tubo flexible
Flexible piping
Conduit flexible

4 Abrazadera araña
Spider bracket
Bride araignée

5 Manguito flex-flex, manguito flex-hembra, manguito flex-silicona / flex-silicona
Flex-flex hose, flex-female, flex-silicone / flex-silicone connection hose
Manchette flex-flex, manchette de raccordement flex-femelle, raccord flex-silicone / flex-silicone

6 Manguito unión macho-flex y macho / flex-silicona
Flex-male and silicone-flex male connection hose
Manchette de raccordement mâle-flex et mâle / flex-silicone

7 Te 93°, codo 87° fijación a suelo
"T"piece 93°, elbow 87° floor fastening
Te 93°, coude 87° fixation au sol

8 Te inspección con tapa
Inspection module with cap
Té inspection avec trappe

9 Base inicial
Floor base
Plaque de départ

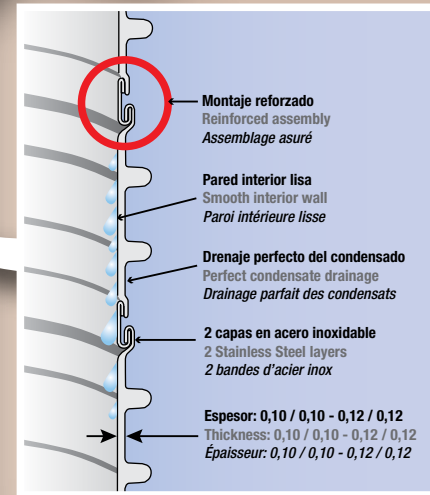
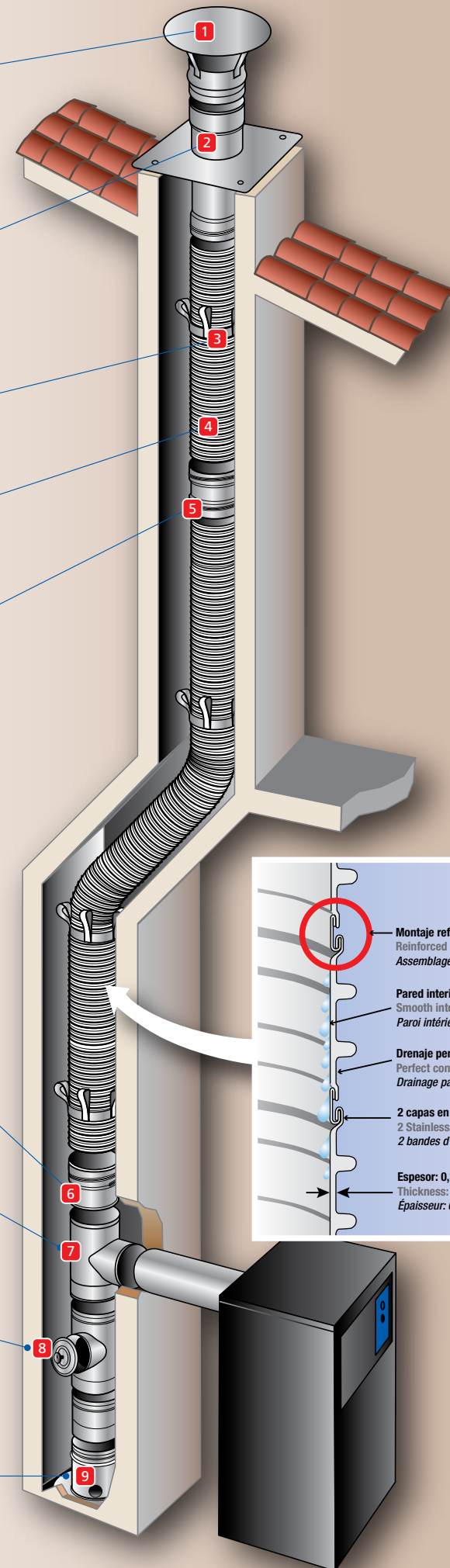

CE Especificaciones de acuerdo a la legislación europea en productos de construcción CPR
Specifications according to EU product regulations of construction CPR
Spécifications Selon la réglementation européenne concernant les produits de construction CPR

AISI 316L
(1.4404) 2R

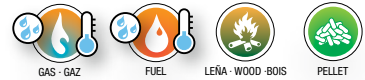

1856-2

Ø80-300
T200 P1 W Vm L50010 O
T200 P1 W Vm L50012 O
T450 N1 D Vm L50010 G
T450 N1 D Vm L50012 G

AISI 904L
(1.4539) 2B



1856-2

Ø80-300
T200 P1 W Vm L70010 O
T200 P1 W Vm L70012 O
T450 N1 D Vm L70010 G
T450 N1 D Vm L70012 G

Empaquetado | Packaging | Emballage

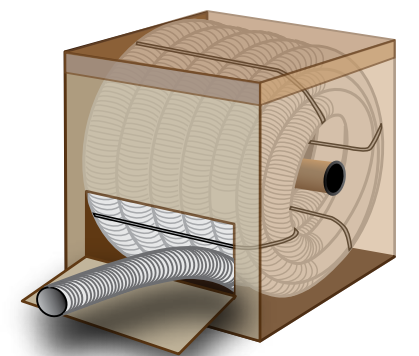

Referencia Reference Référence	Ref.	2700854	Unidad de embalaje Packaging unit Unités par emballage
Precio unidad o metro € Unit or meter price, € Prix unité ou mètre €	€ m.	36,42 40	

Tubo flexible
Flexible piping
Conduit flexible

Tubo flexible - doble capa | Flexible piping - with smooth core | Conduit flexible - double couche

Espesor Thickness Épaisseur	ØD mm							
		80	90	100	110	120	125	
0,10 - 0,10	AISI 316L-304	Ref.	2700986	2700987	2700988	2700989	2700990	2700991
		€ m.	19,88 60	21,97 60	24,07 55	27,10 55	29,27 50	30,28 50
	AISI 316L-316L	Ref.	4015218	4015219	4015220	4015221	4015222	4015223
		€ m.	22,47 60	24,94 60	27,39 55	30,71 55	33,24 50	34,39 50
	AISI 904L-316L	Ref.	4015502	4015503	4015504	4015505	4015506	4015507
		€ m.	35,96 60	40,09 60	44,23 55	49,25 55	53,40 50	55,42 50
0,12 - 0,12	AISI 316L-316L	Ref.	4015233	4015234	4015235	4015236	4015237	4015238
		€ m.	26,45 60	29,34 60	32,30 55	36,13 55	39,03 50	40,47 50



130	140	150	160	180	200	220	230	250	300
2700945	2700992	2700854	2700855	2700856	4008034	2700993	4021154	2700858	2700994
31,36 50	33,45 50	36,42 40	38,88 40	43,72 30	46,91 30	54,48 20	56,60 10	62,22 10	72,77 5
4015224	4015225	4015226	4015227	4015228	4015229	4015230	4021152	4015231	4015232
35,63 50	38,08 50	41,33 40	44,16 40	49,57 30	53,40 30	61,64 20	64,09 10	70,39 10	82,60 5
4015508	4015509	4015510	4015511	4015512	4015513	4015514	4015515	4015516	4015517
57,46 50	61,51 50	66,55 40	71,09 40	79,85 30	86,76 30	98,77 20	102,81 10	112,64 10	133,00 5
4015239	4015240	4015241	4015242	4015243	4015244	4015245	4014647	4015246	4015247
41,98 50	44,88 50	48,63 40	51,95 40	58,39 30	63,08 30	72,41 20	75,29 10	82,60 10	97,19 5



Manguito unión y terminal obra
Fitting and end piece
Manchette de raccordement et terminal boisseau

Manguito unión macho-flex silicona | Silicone flex-male connection hose | Manchette de raccordement

ØD mm							
	80	90	100	110	120	125	
AISI 316L	Ref.	4016321	4018107	4018108	-	4018109	4018110
	€ U.	26,62 1	29,97 1	32,22 1	-	51,27 1	53,61 1
ØD SP	80	100	100	110	125	125	



Manguito unión flex silicona-flex silicona | Silicone flex-silicone flex connection hose | Manchette de

ØD mm							
	80	90	100	120	125		
AISI 316L	Ref.	4016319	4018117	4018118	-	4018119	4018120
	€ U.	47,25 1	52,67 1	57,43 1	-	94,04 1	97,78 1



Manguito flex-flex | Flex-flex hose | Manchette flex-flex

ØD mm							
	80	90	100	110	120	125	
AISI 316L	Ref.	4020978	4020979	4020980	4020981	4020982	4020983
	€ U.	36,51 1	36,75 1	36,93 1	37,45 1	38,98 1	39,79 1



Manguito unión flex-hembra | Flex-female connection hose | Manchette de raccordement flex-femelle

ØD mm							
	80	90	100	110	120	125	
AISI 316L	Ref.	4017142	4023522	4017143	4017157	4017158	4017168
	€ U.	33,43 1	34,48 1	35,17 1	36,10 1	38,06 1	38,15 1
ØD SP	80	80	100	110	125	125	



Manguito unión macho-flex | Flex-male connection hose | Manchette de raccordement mâle-flex

ØD mm							
	80	90	100	110	120	125	
AISI 316L	Ref.	4017250	4026065	4017259	4017260	4017269	4017270
	€ U.	30,92 1	32,74 1	33,44 1	33,72 1	35,18 1	36,51 1
ØD SP	80	80	100	110	125	125	



Terminal obra sin ventilar flex | Flex non-ventilated end piece | Solin toit plat non ventilé flex

ØD mm							
	80	90	100	110	120	125	
AISI 316L	Ref.	4024638	4024640	4024896	4024641	4024643	4024644
	€ U.	61,79 1	61,79 1	63,59 1	64,20 1	65,79 1	66,74 1
ØD SP	80	100	100	110	125	125	
Especificaciones técnicas Technical specifications Spécifications techniques							
A	400	400	400	400	400	400	



mâle-flex silicone

130	140	150	160	180	200	220	230	250	300
4018111	4018112	4018114	4018116	-	-	-	-	-	-
53,61 1	57,48 1	61,54 1	69,20 1	-	-	-	-	-	-
130	139	150	150	180	200	230	230	250	300

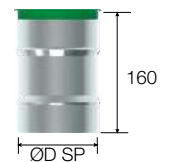

raccordement flex silicone-flex silicone

130	140	150	160	180	200	220	230	250	300
4018121	4018122	4018123	4018124	-	-	-	-	-	-
97,78 1	104,23 1	111,59 1	125,31 1	-	-	-	-	-	-

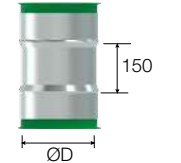

130	140	150	160	180	200	220	230	250	300
4020984	4020985	4020986	4020987	4020988	4020989	4020990	4020505	4020991	4020992
40,82 1	40,92 1	41,01 1	42,03 1	42,69 1	45,63 1	46,25 1	46,95 1	47,10 1	54,98 1

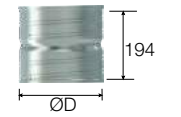

130	140	150	160	180	200	220	230	250	300
4017169	4023525	4017190	4017191	4017201	4017202	4017237	4023526	4017238	4017249
39,30 1	40,32 1	40,53 1	41,52 1	42,18 1	45,07 1	45,69 1	47,32 1	49,21 1	58,02 1
130	139	150	150	180	200	230	230	250	300

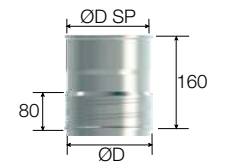

130	140	150	160	180	200	220	230	250	300
4017330	4017332	4017342	4017343	4017354	4017355	4027248	4027250	4017366	4017367
37,75 1	39,25 1	40,02 1	41,00 1	41,64 1	44,53 1	45,22 1	45,64 1	45,96 1	53,75 1
130	139	150	150	180	200	230	230	250	300



130	140	150	160	180	200	220	230	250	300
4024645	4024646	4024647	4024648	4024649	4024650	4024651	4024652	4024653	4024654
68,29 1	68,73 1	69,17 1	69,83 1	73,28 1	74,20 1	76,01 1	78,29 1	84,21 1	105,02 1
130	139	150	150	180	200	230	230	250	300

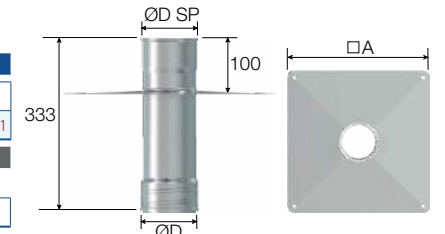

Abrazadera
Bracket
Bride, Collier

Abrazadera de araña | Spider bracket | Bride araignée

ØD mm							
	80	90	100	110	120	125	
AISI 304	Ref.	4008372	4018692	4018448	4018693	4018694	4018695
	€ U.	32,31 1	32,69 1	33,24 1	33,56 1	34,06 1	34,27 1



Abrazadera terminal flexible | Flexible end-piece bracket | Collier haut de tubage flexible

ØD mm							
	80	90	100	110	120	125	
AISI 304	Ref.	4015960	4020581	4015962	4020583	4018310	4016065
	€ U.	22,40 1	22,74 1	23,08 1	23,41 1	23,91 1	24,42 1



130	140	150	160	180	200	220	230	250	300
4013533	4021417	4009721	4025627	4012491	4016687	4025628	4027251	4025629	4016411
34,58 1	35,10 1	36,62 1	38,02 1	38,66 1	40,87 1	41,05 1	41,48 1	41,58 1	41,99 1

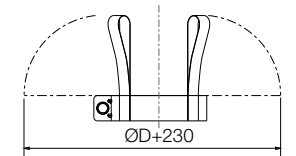

130	140	150	160	180	200	220	230	250	300
4020589	4016222	4016223	4020590	4016176	4020591	4023494	4023519	4018772	4023520
25,08 1	25,93 1	26,58 1	27,59 1	30,10 1	32,61 1	34,86 1	36,01 1	39,50 1	42,81 1

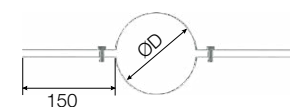

16 AC

Accesorios
Accessories
Accessoires

Cubreaguas, salidas de techo y accesorios
Roof flashing, rooftops and accessories
Solins, sorties de toit et accessoires

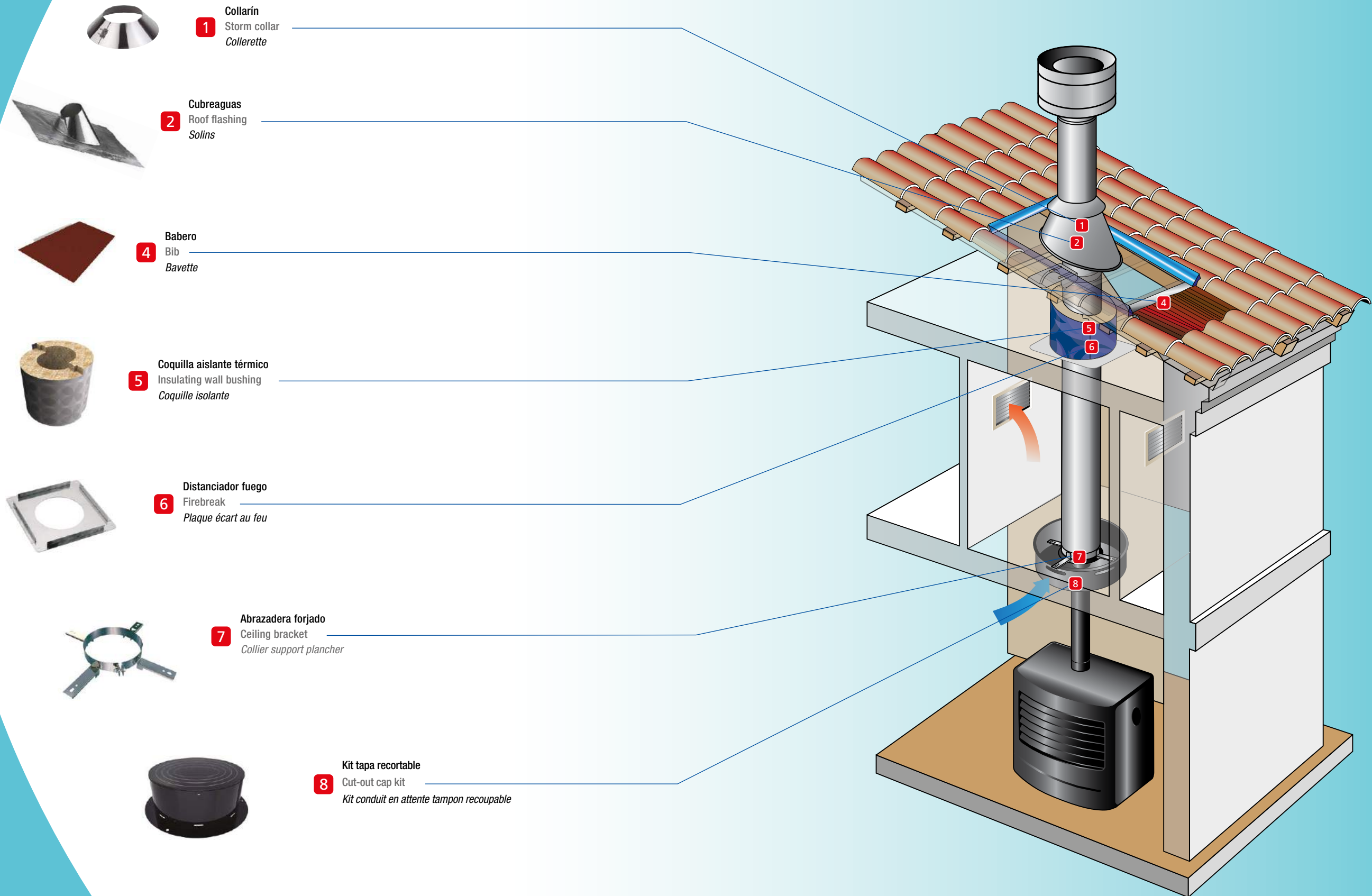

fabricado en: | made of: | fabriquée en: | AISI 304

Cubreaguas
Roof flashing
Solin

Simple pared Single wall Simple paroi	Ø	80	100	110	125	130	139
Doble pared Double wall Double paroi	Ø					80	
Concéntricos Concentrics Concentriques	Ø				80/125	80/130	

Cubreaguas inoxidable horizontal + collarín 75mm | Horizontal stainless steel roof flashing + Storm collar 75mm

Ref.	2700944	2700939	4019534	4013886	2700940	4021387
€ U.	62,31	68,12	68,17	68,17	70,15	73,46

Cubreaguas inoxidable 5° - 25° + collarín 75mm | Stainless steel roof flashing 5° - 25° + Storm collar 75mm

Ref.	4026713	4026715	4026716	4026717	4026718	4026719
€ U.	131,20	134,28	135,30	137,86	137,86	138,38

Cubreaguas inoxidable 25° - 45° + collarín 75mm | Stainless steel roof flashing 25° - 45° + Storm collar 75mm

Ref.	4026730	4026731	4026732	4026733	4026734	4026735
€ U.	134,31	137,20	138,86	141,21	141,40	141,77

Cubreaguas inoxidable 45° - 60° + collarín 75mm | Stainless steel roof flashing 45° - 60° + Storm collar 75mm

Ref.	4026745	4026746	4026748	4026749	4026751	4026752
€ U.	147,74	151,32	152,74	155,04	154,53	155,54

Cubreaguas plomo 5° - 25° + collarín 75mm | Lead roof flashing 5° - 25° + Storm collar 75mm

Ref.	4007495	4007496	4019535	4013887	4007497	4021388
€ U.	143,81	150,46	156,97	161,86	172,52	174,26

Cubreaguas plomo 25° - 45° + collarín 75mm | Lead roof flashing 25° - 45° + Storm collar 75mm

Ref.	4007506	4007507	4019538	4013888	4007508	4021392
€ U.	153,06	160,14	167,07	172,28	183,62	185,47

Cubreaguas plomo 45° - 60° + collarín 75mm | Lead roof flashing 45° - 60° + Storm collar 75mm

Ref.	4021908	4021909	4021911	4021912	4021913	4021914
€ U.	176,02	184,16	192,13	198,12	207,00	213,29

Cubreaguas atornillar | Screwed roof flashing | Solin à visser

Kit fijación | Fastening kit | Kit fixation



ØD	80-180	200-300	350-700
< 150° EPDM	Ref. 5003944	5003946	5005824
	€ U. 38,15	96,66	418,86
< 200° SILICONE	Ref. 5005825	5005826	5005827
	€ U. 57,45	137,74	723,34

ØD	80-180	200-700
Ref.	4035361	4035363
€ U.	16,15	26,44

Babero | Bib | Bavette RAL 7022

Ref.	4025975
€ U.	60,90

Babero | Bib | Bavette RAL 8004

Ref.	4025978
€ U.	60,90

Accesorio para * | Accessory for * | Accessoire pour *

Accesorio para * | Accessory for * | Accessoire pour *

Referencia Reference Référence	Ref.	2700868	Unidad de embalaje Packaging unit Unités par emballage
Precio unidad € Unit price, € Prix unité €	€ U.	75,85	1

150	153	180	200	230	250	300	350	400
100		125 - 130	150	180	200	250	300	350
100/150		110/180	130/200		150/250	180/300	200/350	250/400

Solin inox. horizontal + colerette 75mm

2700868	2700868	2700941	2700807	2500210	2700942	2700943	2700938	4009572
75,85	75,85	86,80	95,64	114,59	119,46	163,41	203,37	255,43

Solin inox. 5° - 25° + colerette 75mm

4026720	4026720	4026721	4026722	4026723	4026724	4026725	4026726	4026727
140,73	140,73	156,83	162,98	172,71	177,84	189,22	207,05	219,35

Solin inox. 25° - 45° + colerette 75mm

4026736	4026736	4026737	4026738	4026740	4026741	4026742	4026743	4026744
143,98	143,98	160,53	166,86	177,16	182,31	193,64	212,18	224,54

Solin inox. 45° - 60° + colerette 75mm

4026753	4026753	4026755	4026756	4026757	4026759	4026760	4026762	4026763
159,58	159,58	177,76	183,82	194,93	200,99	212,42	232,02	245,76

Solin en plomb 5° - 25° + colerette 75mm

4007498	4007498	4007499	4007500	4007501	4007502	4007503	4007504	4007505
177,37	177,37	188,96	201,34	210,41	218,67	232,76	249,20	274,78

Solin en plomb 25° - 45° + colerette 75mm

4007509	4007509	4007510	4007511	4007512	4007513	4007514	4007515	4007516
188,78	188,78	201,12	214,30	223,96	232,74	247,74	265,23	292,46

Solin en plomb 45° - 60° + colerette 75mm

4021915	4021915	4008453	4008452	4014086	4014381	4014382	4021916	4021918
217,10	217,10	231,29	246,44	257,55	264,00	284,90	305,02	336,33

Cubreaguas residencial | Residential roof flashing | Solin résidentiel

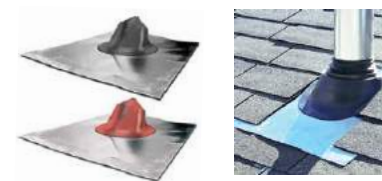

ØD	80 - 200	230 - 250	300 - 450
< 150° EPDM	Ref. 5005829	5005830	5005831
	€ U. 81,89	118,54	250,73
< 200° SILICONE	Ref. 5005832	5005833	5005834
	€ U. 93,97	132,44	301,78

Espuma poliéster autoadhesiva para cubreaguas 1m

Self-adhesive polyester foam for roof flashing 1m

Mousse polyester autocollante pour solin 1m

Ref.	2045889
€ U.	3,69

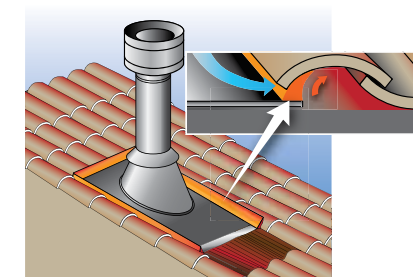

fabricado en: | made of: | fabriquée en: | **AISI 304**

Collarín
Storm collar
Collerette

Simple pared Single wall Simple paroi	Ø	80	100	110	125	130	139
Doble pared Double wall Double paroi	Ø				80/125	80	
Concéntricos Concentrics Concentriques	Ø				80/125	80/130	

Collarín 75mm | Storm collar 75mm | Collerette 75mm



Ref.	4019980	4019981	4019982	4021061	4019983	4021389
€ U.	18,95	19,57	21,63	22,85	23,51	24,74

Collarín 30mm | Storm collar 30mm | Collerette 30mm



Ref.	4019715	4019716	4019717	4022454	4019718	4022459
€ U.	17,23	17,79	19,66	20,77	21,38	22,49

Simple pared Single wall Simple paroi	Ø	80	100	110	125	130	139
Doble pared Double wall Double paroi	Ø				80/125	80	
Concéntricos Concentrics Concentriques	Ø				80/125	80/130	

Rosetón | Finishing collar | Rosace



Ref.	4007378	2700643	4022496	4013910	2700632	4022497
€ U.	19,04	19,57	20,53	21,18	21,63	22,66

Especificaciones técnicas | Technical specifications | Spécifications techniques

ØDe	200	200	200	230	230	250

Embellecedor techo horizontal 1 pieza | Horizontal sloping roof trim 1 unit | Plaque de finition 1 pièce



Ref.	4014804	4015186	4019542	4022448	4014805	4021405
€ U.	12,87	13,91	15,42	19,06	20,74	22,50

Embellecedor techo horizontal 2 piezas | Horizontal sloping roof trim 2 units | Plaque de finition 2 pièces



Ref.	4019832	4019833	4019835	4022449	4019836	4022450
€ U.	14,80	15,99	17,74	21,91	23,85	25,87

Embellecedor 5° a 25° SP 2 piezas | Sloping roof trim 5° to 25° SP 2 units | Plaque de finition 5° à 25° SP 2 pièces



Ref.	4015180	4015181	4019543	4022447	4015182	4021404
€ U.	15,91	17,19	19,07	23,56	25,64	27,81

Embellecedor 25° a 45° SP 2 piezas | Sloping roof trim 25° to 45° SP 2 units | Plaque de finition 25° à 45° SP 2 pièces



Ref.	4013413	4015122	4019544	4022446	4015123	4021403
€ U.	16,79	18,14	20,12	24,85	27,05	29,34

Embellecedor 45° a 60° SP 2 piezas | Sloping roof trim 45° to 60° SP 2 units | Plaque de finition 45° à 60° SP 2 pièces



Ref.	4017680	4017681	4017682	4017683	4017684	4017685
€ U.	17,92	19,36	21,47	26,53	28,87	31,33

Simple pared Single wall Simple paroi	Ø	80	100	110	125	130	139
Doble pared Double wall Double paroi	Ø				80/125	80	
Concéntricos Concentrics Concentriques	Ø				80/125	80/130	

Distanciador fuego ventilado | Ventilated firebreak | Plaque écart au feu ventilée



Ref.	4016780	4016781	4022462	4016782	4016783	4021407
€ U.	43,17	47,13	49,11	50,99	51,64	53,68

Distanciador fuego | Firebreak | Plaque écart au feu



Ref.	4019112	4019113	4022464	4019114	4018288	4021406
€ U.	35,70	37,09	37,91	38,74	39,64	40,01

Referencia	Ref.	4019984	Unidad de embalaje
Reference	Ref.	4019984	Packaging unit
Référence	Ref.	4019984	Unités par emballage
Precio unidad €	€ U.	27,07	1
Unit price, €	€ U.	27,07	1
Prix unité €	€ U.	27,07	1

150	153	180	200	230	250	300	350	400
100		125 - 130	150	180	200	250	300	350
100/150		110/180	130/200		150/250	180/300	200/350	250/400

4019984	4021390	4019985	4019986	4019987	4019988	4019990	4019991	4021062
27,07	27,81	30,47	32,96	36,89	41,20	51,50	67,98	77,68

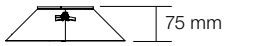

4019720	4022467	4019721	4019722	4019923	4019723	4019724	4019725	4019726
24,61	25,28	27,70	29,96	33,54	37,45	46,82	61,80	70,62

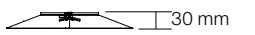

150	153	180	200	230	250	300	350	400
100		125 - 130	150	180	200	250	300	350
100/150		110/180	130/200		150/250	180/300	200/350	250/400

2700633	2700633	4008224	4011484	4022498	4011483	4011482	4022499	4022500
23,69	23,69	25,75	29,00	30,80	32,45	39,91	46,30	55,13

250	250	300	300	350	350	400	450	500

4014806	4014806	4015187	4015188	4012816	4013363	4017666	4017667	4017668
23,76	23,76	31,59	37,12	43,44	51,33	63,18	75,02	84,50

4019837	4019837	4019838	4019839	4019840	4019841	4019853	4019854	4019855
27,32	27,32	36,33	42,68	49,95	59,03	72,66	86,28	97,18

4015183	4015183	4015184	4015185	4013415	4013417	4017653	4016684	4016685
29,37	29,37	39,05	45,89	53,70	63,46	78,10	92,75	104,46

4015177	4015177	4015178	4015179	4012817	4013362	4016289	4016686	4017665
30,98	30,98	41,20	48,41	56,65	66,95	82,40	97,85	110,21

4017686	4017686	4017687	4017688	4017689	4017690	4017691	4017692	4017693
33,07	33,07	43,98	51,68	60,47	71,47	87,96	104,45	117,65

150	153	180	200	230	250	300	350	400
100		125 - 130	150	180	200	250	300	350
100/150		110/180	130/200		150/250	180/300	200/350	250/400

4016784	4016784	4016785	4016786	4016428	4016407	4016787	4019976	4029518
54,50	54,50	58,79	61,14	67,27	70,48	79,40	90,27	101,25

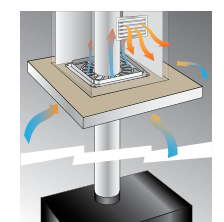

Distanciador fuego ventilado
Ventilated firebreak
Plaque écart au feu ventilée

4019115	4019115	4018697	4018698	4018699	4018700	4018701	4019979	4040444
41,20	41,20	44,29	46,35	50,47	54,59	59,74	70,04	78,89

Distanciador fuego
Firebreak
Plaque écart au feu

fabricado en: | made of: | fabriquée en: | AISI 304

Distanciador fuego
Firebreak
Plaque écart au feu

Simple pared Single wall Simple paroi	Ø	80	100	110	125	130	139
Doble pared Double wall Double paroi	Ø				80/125	80/130	
Concéntricos Concentrics Concentriques	Ø						

Distanciador fuego estanco horizontal | Sealed firebreak horizontal | Plaque écart au feu étanche horizontale



Ref.	-	-	-	-	4025575	-
€ U.	-	-	-	-	65,96	1

Kit embellecedor techo horizontal 2 piezas | Horizontal sloping roof trim kit 2 units | Kit plaque de finition 2 pièces



Ref.	-	-	-	-	4025768	-
€ U.	-	-	-	-	64,44	1

Distanciador fuego estanco | Sealed firebreak | Plaque écart au feu étanche 5° / 25°



Ref.	-	-	-	-	4025644	-
€ U.	-	-	-	-	70,49	1

Kit embellecedor SP 2 piezas | Sloping roof trim kit SP 2 units | Kit plaque de finition SP 2 pièces 5° / 25°



Ref.	-	-	-	-	4025670	-
€ U.	-	-	-	-	75,01	1

Distanciador fuego estanco | Sealed firebreak | Plaque écart au feu étanche 25° / 45°

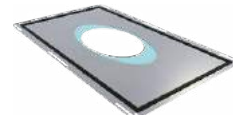

Ref.	-	-	-	-	4025651	-
€ U.	-	-	-	-	75,78	1

Kit embellecedor SP 2 piezas | Sloping roof trim kit SP 2 units | Kit plaque de finition SP 2 pièces 25° / 45°



Ref.	-	-	-	-	4025681	-
€ U.	-	-	-	-	79,40	1

Distanciador fuego estanco | Sealed firebreak | Plaque écart au feu étanche 45° / 60°

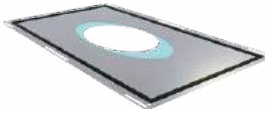

Ref.	-	-	-	-	4025664	-
€ U.	-	-	-	-	83,36	1

Kit embellecedor SP 2 piezas | Sloping roof trim kit SP 2 units | Kit plaque de finition SP 2 pièces 45° / 60°



Ref.	-	-	-	-	4025710	-
€ U.	-	-	-	-	87,76	1

Aislante paso mural
Insulating wall bushing
Coquille isolante

Aislante paso mural | Insulating wall bushing | Coquille isolante L 330 -80 mm



Ref.	-	-	-	-	4026212	-
€ U.	-	-	-	-	65,09	1

Aislante paso mural | Insulating wall bushing | Coquille isolante L 500 -80 mm



Ref.	-	-	-	-	4026218	-
€ U.	-	-	-	-	84,84	1

Aislante paso mural | Insulating wall bushing | Coquille isolante L 660 -80 mm



Ref.	-	-	-	-	4026224	-
€ U.	-	-	-	-	109,71	1

Referencia Reference Référence	Ref.	4025579	Unidad de embalaje Packaging unit Unités par emballage
Precio unidad € Unit price, € Prix unité €	€ U.	70,14	1

150	153	180	200	230	250	300	350	400
100		125 - 130	150	180	200	250	300	350
100/150		110/180	130/200		150/250	180/300	200/350	250/400

4025579	4025579	4025580	4025581	4025582	4025583	4034286	-	-
70,14	70,14	73,06	77,60	82,56	85,93	92,70	-	-

4025790	4025790	4025792	4025793	4025794	4025795	4025796	-	-
67,14	67,14	77,13	80,50	85,54	88,86	92,11	-	-

4025646	4025646	4025647	4025648	4025649	4025650	4034283	-	-
67,14	67,14	77,13	80,50	85,54	88,86	92,11	-	-

4025671	4025671	4025672	4025678	4025679	4025680	4025682	-	-
78,39	78,39	92,32	95,50	102,53	106,58	110,63	-	-

4025652	4025652	4025653	4025654	4025662	4025663	4034284	-	-
80,83	80,83	86,37	90,86	97,67	100,72	108,51	-	-

4025705	4025705	4025706	4025707	4025708	4025709	4025740	-	-
81,75	81,75	99,28	104,69	113,85	117,68	121,42	-	-

4025665	4025665	4025666	4025667	4025668	4025669	4034285	-	-
88,91	88,91	95,00	99,95	107,44	110,79	119,36	-	-

4025711	4025711	4025712	4025713	4025714	4025715	4025741	-	-
92,02	92,02	97,47	121,60	133,19	139,73	143,20	-	-

4026213	4026213	4026214	4026215	4026216	4026217	4025977	4040050	-
70,39	70,39	73,75	76,04	80,49	82,01	94,95	109,18	-

4026219	4026219	4026220	4026221	4026222	4026223	4025980	4040051	-
90,89	90,89	95,95	97,85	103,47	105,89	124,37	143,00	-

4026225	4026225	4026226	4026227	4026228	4026229	4025982	4040052	-
118,00	118,00	125,01	127,05	130,67	134,09	158,83	177,16	-

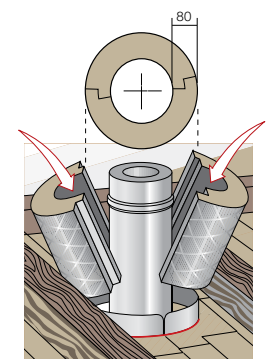
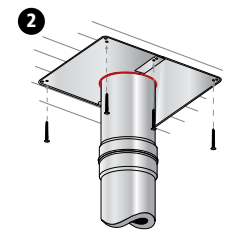
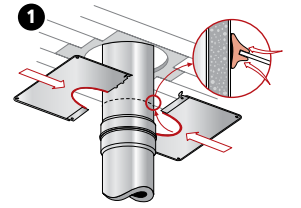

fabricado en: | made of: | fabriquée en: | AISI 304

Puerta limpieza
Cleaning door
Trappe de ramonage

Puerta limpieza | Cleaning door | Trappe de ramonage

 Empotrable 14 x 20 Recessed 14 x 20 Encastrable 14 x 20	 Con cajón empotrable 250mm With recessed drawer 250mm Avec boîtier encastrable 250mm	 Puerta de ventilación Ventilation door Trappe de ventilation												
<table border="1"> <tr><td>Ref.</td><td>5003920</td></tr> <tr><td>€ U.</td><td>56,28 1</td></tr> </table>	Ref.	5003920	€ U.	56,28 1	<table border="1"> <tr><td>Ref.</td><td>5003919</td></tr> <tr><td>€ U.</td><td>93,09 1</td></tr> </table>	Ref.	5003919	€ U.	93,09 1	<table border="1"> <tr><td>Ref.</td><td>5003913</td></tr> <tr><td>€ U.</td><td>50,22 1</td></tr> </table>	Ref.	5003913	€ U.	50,22 1
Ref.	5003920													
€ U.	56,28 1													
Ref.	5003919													
€ U.	93,09 1													
Ref.	5003913													
€ U.	50,22 1													

EN ESPERA
WAITING
EN ATTENTE

Salida a techo
Rooftop
Sortie de toit

Kit Salida a techo + módulo DP | Rooftop kit + DW module | KIT Sortit de toit + élément droit DP

Ø	1					
	130	150	180	200	250	
Ref.	4025989	4025990	4025994	4025995	4025996	4025984
€ U.	687,83 1	690,82 1	696,95 1	700,44 1	709,17 1	602,65 1

Kit Salida a techo + módulo DP | Rooftop kit + DW module | KIT Sortit de toit + élément droit DP

Ø	1					
	130	150	180	200	250	
Ref.	4026000	4026001	4026002	4026003	4026004	4025987
€ U.	687,83 1	690,82 1	696,95 1	700,44 1	709,17 1	602,65 1

Kit Salida a techo + módulo DP | Rooftop kit + DW module | KIT Sortit de toit + élément droit DP

Ø	1					
	130	150	180	200	250	
Ref.	4026005	4026007	4026008	4026010	4026011	4025986
€ U.	687,83 1	690,82 1	696,95 1	700,44 1	709,17 1	602,65 1

Kit Salida a techo + módulo DP · lacado | Rooftop kit + DW module · lacquered | KIT Sortit de toit + élément droit DP · laqué

Ø	1					
	130	150	180	200	250	
Ref.	4026012	4026014	4026015	4026016	4026017	4025988
€ U.	756,62 1	759,91 1	766,65 1	770,49 1	780,08 1	662,92 1

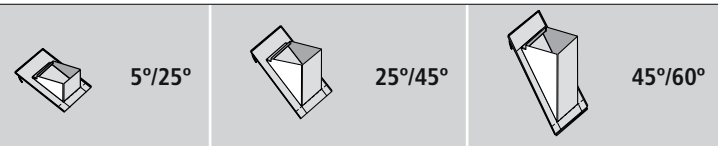

Base estanca salida a techo | Sealed rooftop base | Embase étanche sortie de toit RAL 1015

Ref.	4026018	4026019	4026020
€ U.	237,53 1	270,00 1	285,44 1

Base estanca salida a techo | Sealed rooftop base | Embase étanche sortie de toit RAL 9005

Ref.	4026024	4026025	4026026
€ U.	237,53 1	270,00 1	285,44 1

Base estanca salida a techo | Sealed rooftop base | Embase étanche sortie de toit RAL 7016

Ref.	4026021	4026022	4026023
€ U.	237,53 1	270,00 1	285,44 1

Base estanca salida a techo · lacado | Sealed rooftop base · lacquered | Embase étanche sortie de toit · laqué

Ref.	4026027	4026029	4026030
€ U.	261,28 1	297,00 1	314,00 1

Referencia Reference Référence	Ref.	4025990	Unidad de embalaje Packaging unit Unités par emballage
Precio unidad € Unit price, € Prix unité €	€ U.	690,82 1	

**1 KIT SALIDA A TECHO CONDUCTO EN ESPERA
ROOFTOP KIT PIPING PENDING
KIT SORTIE DE TOIT CONDUIT EN ATTENTE**

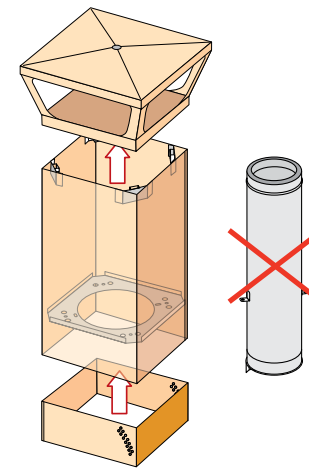

**KIT SALIDA A TECHO + MÓDULO LINEAL
ROOFTOP KIT + DW MODULE
KIT SORTIE DE TOIT + ÉLÉMENT DROIT DP**

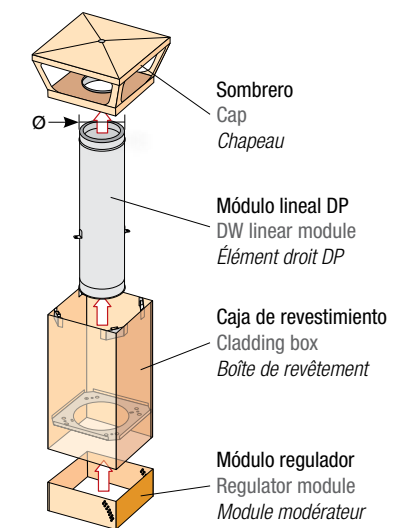

**KIT FIJACIÓN INCLINADO REFORZADO
REINFORCED INCLINED FASTENING KIT
KIT FIXATION RENFORCÉE TOT INCLINÉ**

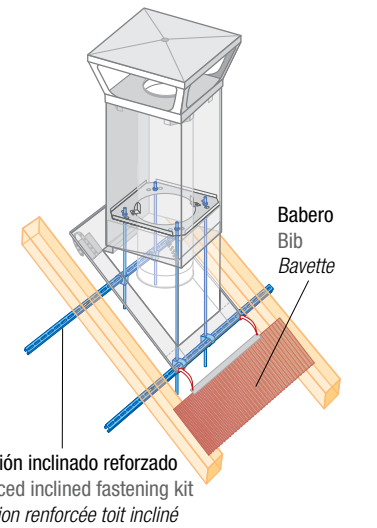

* Kit fijación inclinado reforzado
Reinforced inclined fastening kit
Kit fixation renforcée toit incliné

**BASE ESTANCA
SEALED BASE
EMBASE ETANCHE**

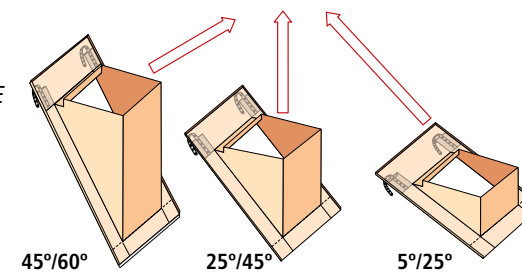

Babero | Bib | Bavette RAL 7022

Ref.	4025975
€ U.	60,90 1

Babero | Bib | Bavette RAL 8004

Ref.	4025978
€ U.	60,90 1

*** Kit fijación inclinado
Inclined fixing kit
Kit de fixation incliné**

Ref.	4026036
€ U.	72,42 1

Embellecedor conducto en espera
Piping trim pending
Plaque de finition conduit en attente

Kit tapa ciega | Blind cap kit | Kit conduit à l'attente tampon plein

	RAL 9002	RAL 9011
Ref.	4025808	4025803
€ U.	146,80 1	146,80 1

Kit tapa recortable | Cut out cap kit | Kit conduit à l'attente tampon recoupable

	RAL 9002	RAL 9011
Ref.	4025809	4025804
€ U.	173,77 1	173,77 1

Tapa ciega | Blind cap | Tampon plein

	RAL 9002	RAL 9011
Ref.	4025806	4025801
€ U.	54,15 1	54,15 1

Tapa recortable | Cut out cap | Tampon recoupable

	RAL 9002	RAL 9011
Ref.	4025807	4025802
€ U.	81,27 1	81,27 1

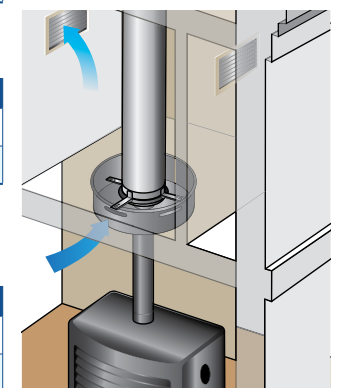
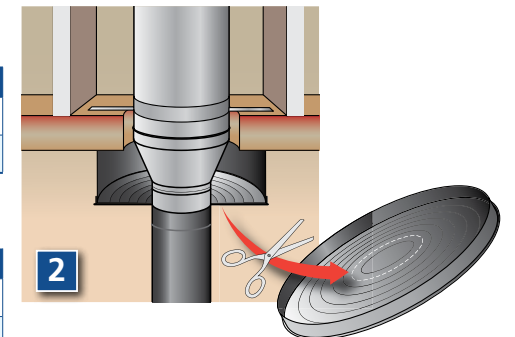

17 CP

Conducto de polipropileno
Polypropylene piping
Conduit de polypropylène

Ø 60 - 200

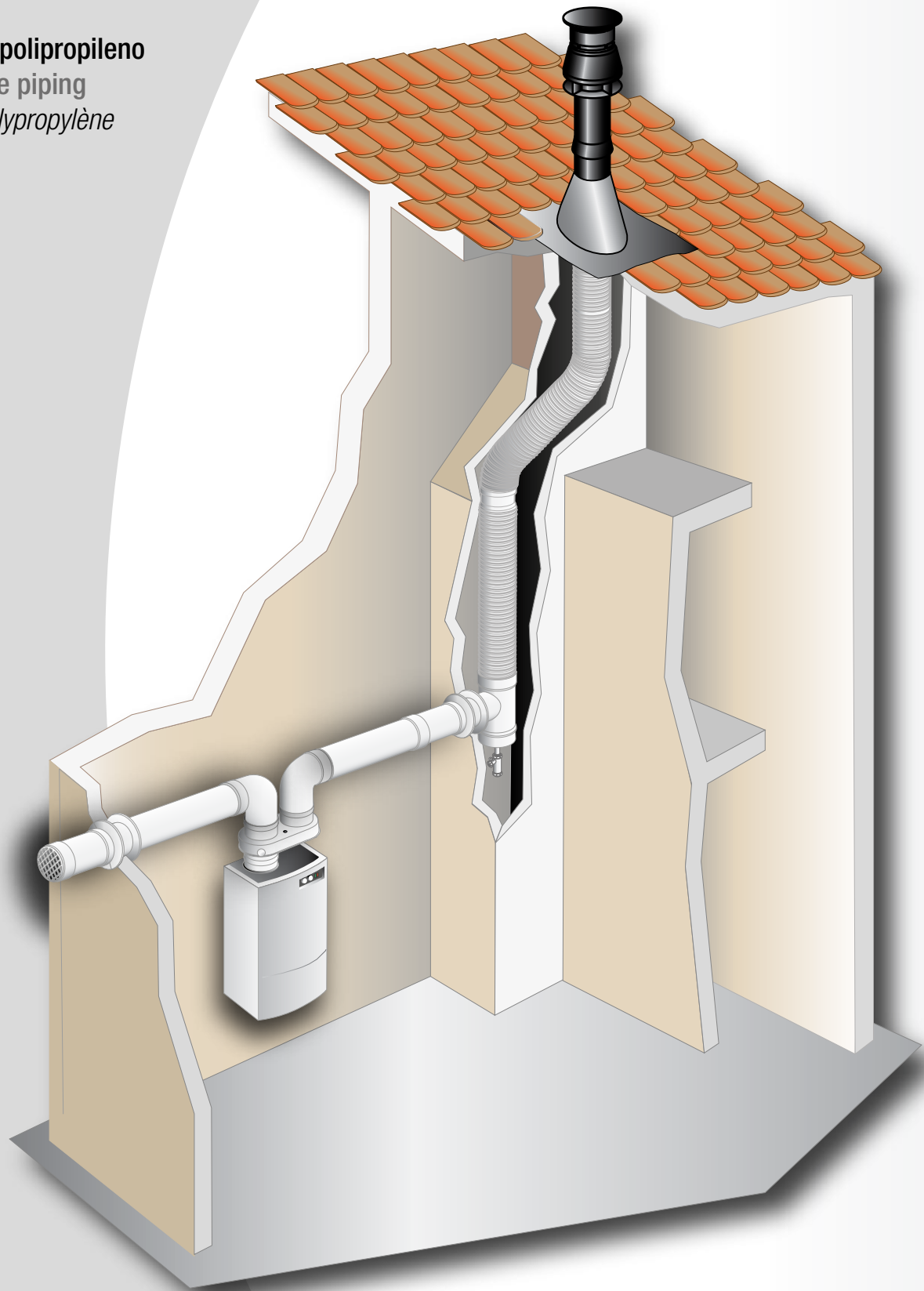

CONDUCTO FLEXIBLE BIFLUJO
BIFLOW FLEXIBLE DUCT
CONDUIT FLEXIBLE BIFLOW

Ø 60 - 300

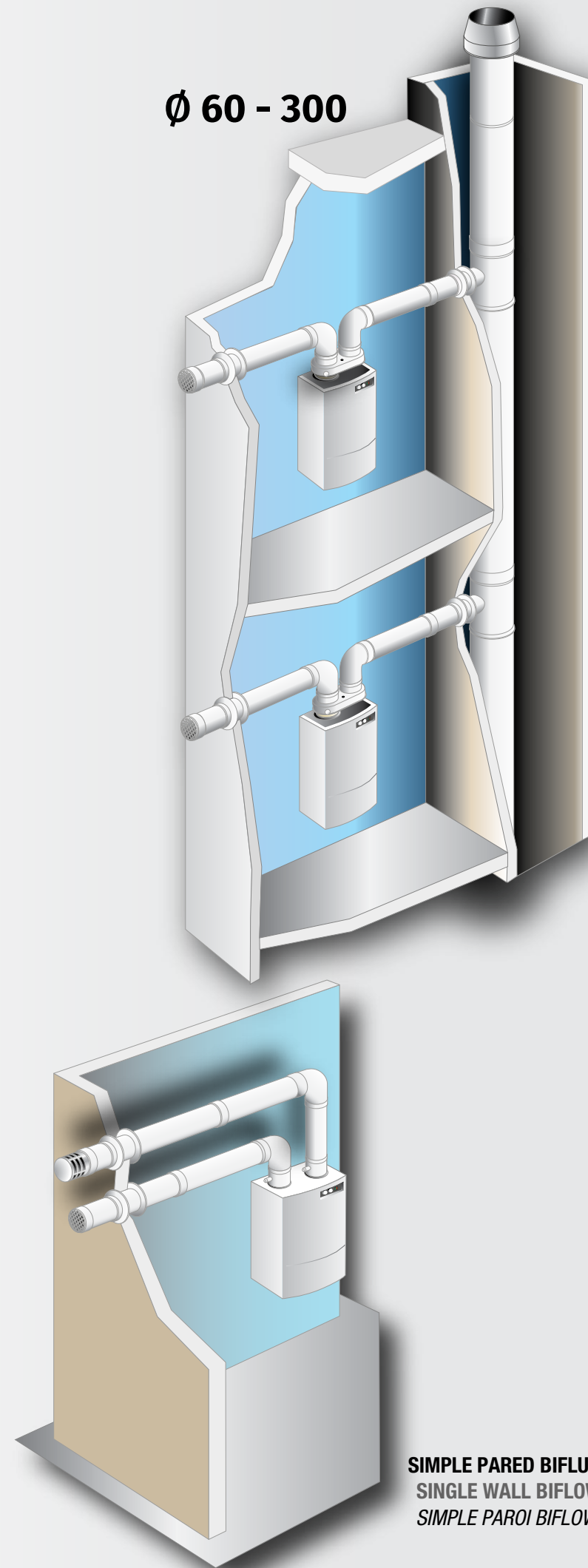

SIMPLE PARED BIFLUJO
SINGLE WALL BIFLOW
SIMPLE PAREOI BIFLOW

CE Especificaciones de acuerdo a la legislación europea en productos de construcción CPR
Specifications according to EU product regulations of construction CPR
Spécifications Selon la réglementation européenne concernant les produits de construction CPR

Grosor Thickness Épaisseur	1,5 mm (min.)
Temperatura máxima Maximum temperature Température maximale	120°
Color Colour Couleur	Blanco White Blanc

CONDUCTO FLEXIBLE BIFLUJO
BIFLOW FLEXIBLE DUCT
CONDUIT FLEXIBLE BIFLOW



UNE-EN 14471

Ø60-80-100-
125-160-200

T120 H1 W 2 O20 I E L

SIMPLE PARED BIFLUJO
SINGLE WALL BIFLOW
SIMPLE PAREOI BIFLOW



UNE-EN 14471

Ø60-80-100-110-125
-160-200-250-300

T120 H1 W 2 O20 I E L

Junta incluida.
Gasket included.
Joint inclus.

Ø 60/100 - 80/125 - 100/150

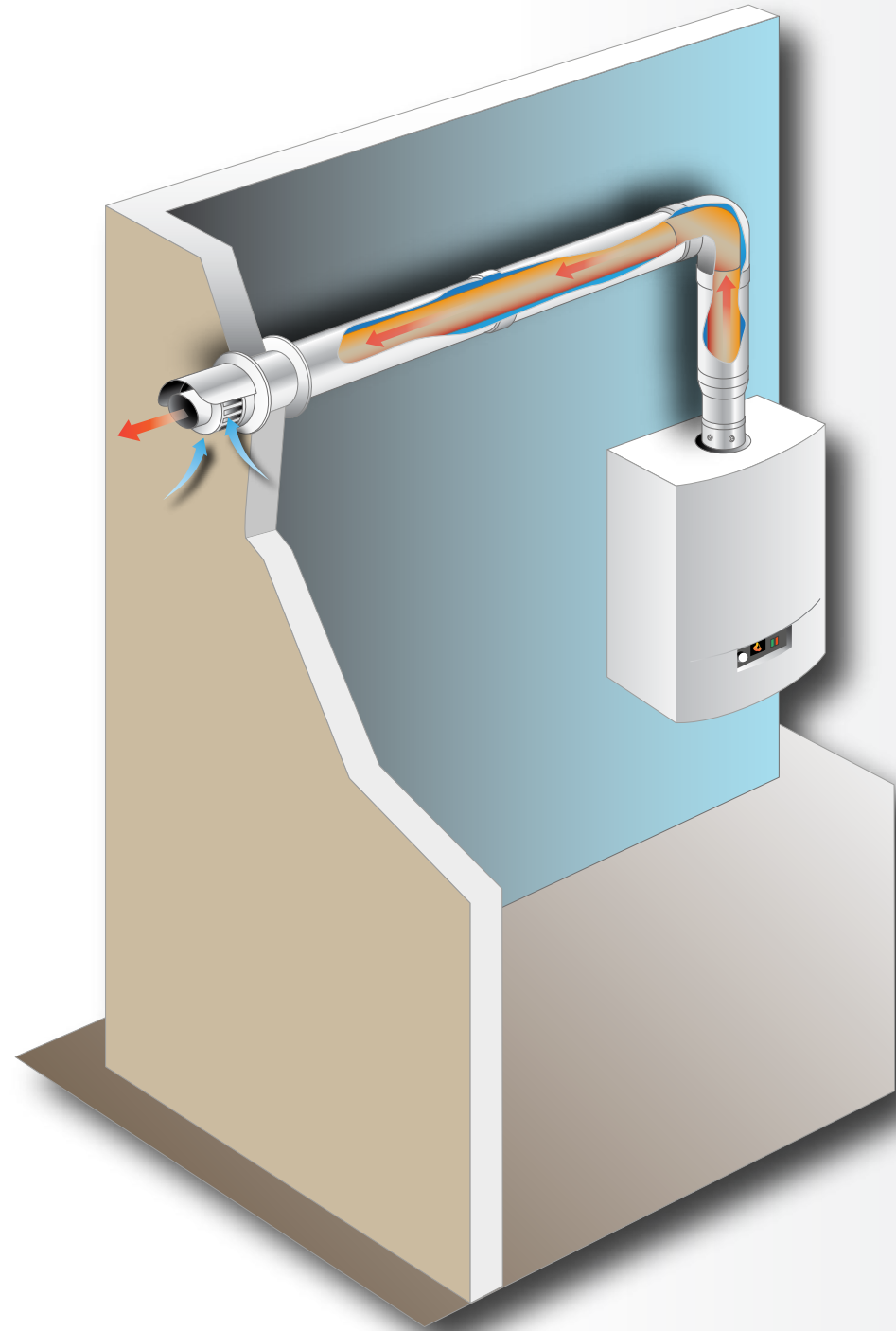

CONDUCTO COAXIAL
COAXIAL DUCT
CONDUIT COAXIAL

Ø 125/200 - 300/450

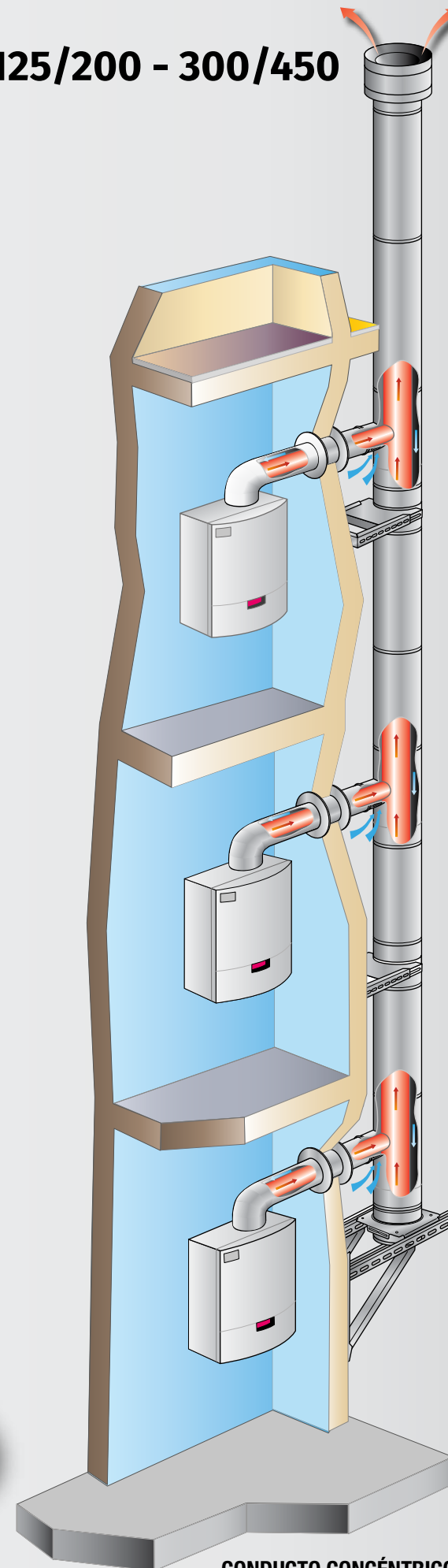

CONDUCTO CONCÉNTRICO COLECTIVO
CONCENTRIC COLLECTIVE PIPING
CONDUIT CONCENRIC COLLECTIVE

CE Especificaciones de acuerdo a la legislación europea en productos de construcción CPR
Specifications according to EU product regulations of construction CPR
Spécifications Selon la réglementation européenne concernant les produits de construction CPR

Grosor Thickness Epaisseur	1,5 mm (min.)
Temperatura máxima Maximum temperature Température maximale	120°
Color PP PP Colour Couleur PP	Blanco White Blanc

CONDUCTO COAXIAL
COAXIAL PIPING
CONDUIT COAXIAL

interior | inside | intérieur

PP

exterior | outside | extérieur

AL

Aluminio
Aluminum
Aluminium



UNE-EN 14471

Ø 60/100-80/125
-100/150

T120 H1 W 2 000 | E L0

CONDUCTO CONCÉNTRICO COLECTIVO
CONCENTRIC COLLECTIVE PIPING
CONDUIT CONCENRIC COLLECTIVE

interior | inside | intérieur

PP

exterior | outside | extérieur

AISI 304

(1.4301) 2R

UNE-EN 14471

Ø 125/200-160/230-200/350
-250/400-300/450

T120 H1 W 2 000 | E L0

Junta incluida.
Gasket included.
Joint inclus.

DECLARACIÓN DE CONFORMIDAD E INFORMACIÓN DEL PRODUCTO DECLARATION OF CONFORMITY AND PRODUCT INFORMATION DÉCLARATION DE CONFORMITÉ ET INFORMATION SUR LE PRODUIT

NOTA: Para diámetros superiores a 300 mm, la distancia a los materiales combustibles se debe incrementar mediante un coeficiente.

NOTE: For diameters more than 300 mm, the distance to combustible materials must be increased by a coefficient.

REMARQUE: Pour les diamètres supérieurs à 300 mm, la distance par rapport aux matériaux combustibles doit être augmentée par un coefficient.

Incremento Increase Augmentation	Ø Diámetros Ø Diameters Ø Diamètres
x 1,5	350 - 450
x 2,0	500 - 600
x 4,0	650 - 700

T300 N1 W V2 L50040 O(20)

Temperatura de trabajo
Operating temperature
Température de travail

Estanqueidad al gas
Gas tightness
Étanchéité au gaz

Resistencia de purga
Purge resistance
Résistance de purge

Resistencia a la corrosión
Rust resistance
Résistance à la rouille

Material pared interior
Interior wall material
Matériel paroi intérieure

Grosor pared interior
Interior wall thickness
Épaisseur de paroi intérieure

Resistencia a la ignición del hollín (G: sí; O: no)
Soot ignition resistance (G: yes; O: no)
Résistance à l'inflammation de la suie (G: oui; O: non)

Distancia material combustible
Distance between combustible material
Distance matériel combustible

UNIDADES DE JUNTAS POR ELEMENTO | GASKET UNITS PER ELEMENT | UNITÉS DE JOINTS PAR ÉLÉMENT



JUNTAS POR ELEMENTO GASKETS PER ELEMENT JOINTS PAR ÉLÉMENT	UNIDADES UNITS UNITÉS
Elementos conductores (módulos lineales, codos, etc.) Smoke piping (linear modules, elbows, etc.) Conduits de fumée (éléments droits, coudés, etc.)	1
Tes "T" pieces Tés	2
Módulos extensibles Extendable modules Éléments télescopiques	2
Módulo de limpieza oval Oval cleaning module Module ramonage ovale	1 (*)
Paso mural extensible Extendable wall bushing Traversée de mur télescopique	1
Paso mural normal Standard wall bushing Traversée de mur normale	0
Adaptador caldera Boiler adapter Adaptateur chaudière	0

(*) 1 x 5003952 adicional para la puerta de limpieza | additional for cleaning door | supplémentaire pour la trappe de ramonage

ESCUADRAS - TABLAS DE DISTANCIAS | SQUARES - DISTANCE TABLES | ÉQUERRES - TABLEAU DE DISTANCES

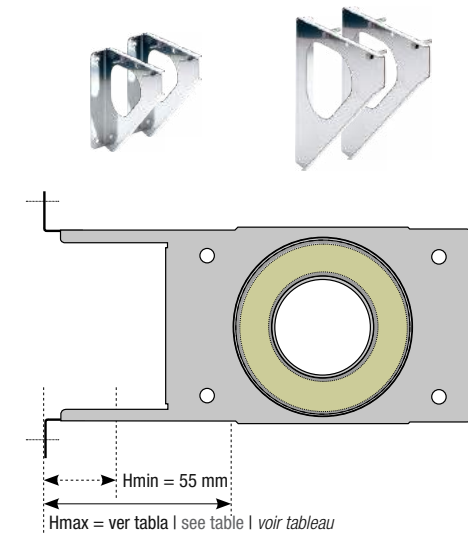

Ø Tubo exterior (mm) Ø External pipe (mm) Ø Pipe extérieure (mm)	Hmax (mm)					
	Escuadra Square Équerre		pequeño petit small		mediano medium moyen	
	pequeño	pequeño	mediano	mediano	grande	grande
80	4019925	150	4019926	250	4019927	-
100	-	150	-	250	-	-
110	-	150	-	250	-	-
125	-	150	-	250	-	-
130	-	150	-	250	-	-
139	-	150	-	250	-	-
150	-	150	-	250	-	-
153	-	150	-	250	-	-
180	-	-	-	150	-	250
200	-	-	-	150	-	250
230	-	-	-	150	-	250
250	-	-	-	150	-	250
300	-	-	-	-	-	150
350	-	-	-	-	-	150
400	-	-	-	-	-	150

CONFIGURACIONES ABRAZADERA FORJADO UNIVERSAL CONFIGURATIONS FOR THE UNIVERSAL CEILING BRACKET POSSIBILITÉS DE MONTAGE DU SUPPORT PLANCHER UNIVERSEL

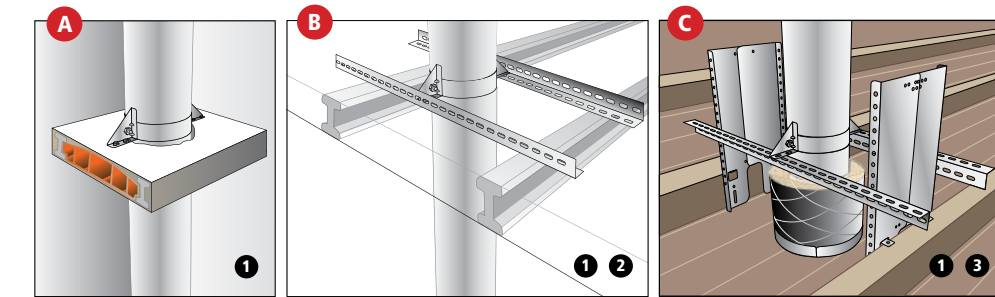

1 Abrazadera forjado universal
Universal ceiling bracket
Collier support plancher universel

2 Fijación forjado angular (2 unidades)
Angular forged fixation (2 units)
Fixation angulaire (2 unités)

3 Kit prolongación forjado
Forged extension kit
Kit extension étage

CONDICIONES RAL | RAL CONDITIONS | CONDITIONS RAL

Pintura Senotherm - Garantizada hasta temperaturas de 600° C
Senotherm paintwork - Guaranteed up to temperatures of 600° C
Peinture Senotherm - Garantie pour températures jusqu'à 600° C

	Suplemento Surcharge Supplément	Pedido mínimo RAL RAL minimum order Commande minimale par RAL
Simple pared Single wall Simple paroi 304	35%	290 €
Simple pared Single wall Simple paroi 316L	30%	360 €

RAL 9011 NEGRO MATE HT (600°) Artículos estandar
RAL 9011 MATT BLACK HT (600°) Standard items
RAL 9011 NOIR MAT HT (600°) Articles standard

	Suplemento Surcharge Supplément	Pedido mínimo RAL RAL minimum order Commande minimale par RAL
Doble pared Double wall Double paroi 316L / 304	25%	700 €
Doble pared Double wall Double paroi 304 / 304	30%	600 €
Concéntrico Concentric Concentrique 316L / 304	25%	700 €
Concéntrico Concentric Concentrique 304 / 304	30%	600 €



• Pintura Epoxy en polvo.
• Llámennos para confirmar vuestro color RAL.
• El plazo de entrega para todos nuestros productos RAL es de 15 días laborables.
• Para pedidos inferiores al pedido mínimo, se aplicará un suplemento de 90 €.
• Para cualquier información adicional, contacte con nosotros.

Epoxy powder coating.
• Call us to confirm your RAL colour.
• The delivery time for all our RAL products is 15 working days.
• For orders below the minimum order, a surcharge of 90 € will be applied.
• For any additional information, please contact us.

Peinture époxy en poudre.
• Contactez-nous pour confirmer votre couleur RAL.
• Le délai de livraison par tous nos produits RAL est de 15 jours ouvrés.
• Pour commandes inférieures à la commande minimale, nous appliquons un supplément de 90 €.
• Pour tout complément d'informations, veuillez nous contacter.

CONDICIONES GENERALES DE VENTA

1. Generalidades y ámbito de aplicación

- Nuestras condiciones generales de pago y entrega se aplican a empresas a efectos del a 1 Codigo de Comercio (22/8/1885) y Ley 7/1998 de 13 de abril. A este efecto, se entenderá por empresario toda persona física o jurídica o sociedades personalizadas con capacidad de obrar con las que se establezca una relación comercial y que ejerza una actividad profesional comercial o por cuenta propia.
- Las siguientes condiciones serán aplicables a todas nuestras ofertas y entregas. Se aplicarán a todas las relaciones comerciales presentes y futuras, aunque no hayan sido acordadas de nuevo explícitamente.
- Las condiciones de compra del cliente no formarán parte del contrato. Tampoco serán aceptadas si, tras su recepción, nos opusiéramos explícitamente. Nuestras condiciones generales de pago y entrega se considerarán aceptadas a más tardar con la recepción de la mercancía y servicios suministrados por nosotros. Las variaciones de estas condiciones sólo serán válidas si se pactan por escrito.
- Los derechos derivados de este acuerdo serán intransferibles.

2. Garantías del contrato

- Todas nuestras ofertas, formuladas por escrito u oralmente, quedan sujetas a confirmación y no tendrán carácter vinculante, es decir, no comprometen a efectuar la entrega. Con la confirmación de pedido, el cliente declara de forma vinculante querer adquirir los artículos pedidos o querer hacer el pedido. Nos reservamos el derecho de aceptar la oferta contractual incluida en el pedido en el plazo de dos (2) semanas tras su recepción. La aceptación será manifestada al cliente por escrito o mediante el suministro de la mercancía. Únicamente se considerará determinante, para el alcance del servicio debido por contrato, nuestra confirmación de pedido.
- Los acuerdos con representantes son vinculantes para el cliente, pero sólo serán válidos si han sido confirmados por escrito por nosotros.
- Nos reservamos los derechos de propiedad y de autor sobre la documentación correspondiente a la oferta. Esta documentación no podrá ser transferida a terceros sin nuestro consentimiento previo. En caso de no efectuarse el pedido, la documentación deberá sernos devuelta en caso de que así lo requiramos y destruída. Los precios de cada una de las posiciones de la oferta sólo tendrán validez al hacer el pedido completo de la presente oferta. Los diseños, ilustraciones, medidas, pesos u otros datos referidos a nuestros servicios sólo serán vinculantes si así se acuerda expresamente por escrito.
- Si el cliente realiza el pedido de la mercancía por vía electrónica, procederemos de manera inmediata a la confirmación del pedido. Esta confirmación de recepción no representa una aceptación vinculante. La confirmación de recepción se puede vincular con una declaración de aceptación. Si el consumidor realiza el pedido de la mercancía por vía electrónica, guardaremos el texto del contrato, y, si lo requiriese, se le enviaría por correo electrónico al cliente junto con las presentes condiciones.
- Nos reservamos el derecho de efectuar modificaciones en el diseño, selección de materiales, especificaciones y tipo de construcción, incluso después de haber enviado la confirmación del pedido, siempre que estas modificaciones no sean incompatibles, ni con la confirmación del pedido, ni con las especificaciones del cliente. El cliente manifestará su conformidad con las modificaciones propuestas, siempre que éstas sean razonables para él.

3. Tolerancias

Las tolerancias se determinan para el cumplimiento de las características dimensionales de nuestros productos. A menos que como proveedor no notifiquemos expresamente lo contrario, fabricamos de acuerdo con nuestras tolerancias estándar.

4. Precios

- Nuestros precios se desprenden de la confirmación de pedido. Nuestros precios son en euros unidad y con la mercancía situada en nuestros almacenes de Sant Jaume de Llierca (Girona) (España), sin incluir embalaje, gastos de envío y de transporte, así como libres de derechos arancelarios (extranjero).
- Si entre la firma del contrato y la entrega o servicio, se incrementasen los precios de nuestros proveedores, nuestros costes (tales como, aumento de los precios de flete, aumentos salariales o del precio de las materias primas) o nuestros impuestos, o se introdujesen otros nuevos, tenemos derecho a incrementar en consecuencia el precio, a no ser que el precio haya sido expresamente fijado.
- En caso de tomar en consideración propuestas de modificación del cliente, tendremos derecho a facturar al cliente los costes adicionales resultantes.
- El IVA se facturará en función de las disposiciones legales. Cualquier aumento del tipo del IVA que tenga lugar entre el pedido y la entrega correrá a cargo del cliente.

5. Condiciones de pago

- El pago de nuestros suministros se realizará, sin ninguna deducción, dentro de los TREINTA (30) días naturales siguientes a su recepción. Transcurrido este plazo, el cliente incurre en demora de pago.
- Además de un acuerdo individual expreso, se requerirá como condición adicional para la concesión de descuentos que todas las facturas anteriores a la fecha se hayan liquidado. Para el cálculo del descuento será determinante el importe neto de la factura, una vez deducidos descuentos, flete y otros gastos que repercutan a terceros.
- No estamos obligados a aceptar letras de cambio, pagarés, cheques o confirming . Sólo aceptaremos letras de cambio sujetas a una posibilidad de descuento. Los cheques, pagarés y letras de cambio se acreditarán una vez que se hayan cobrado en efectivo. En el caso de cesión de créditos una vez que se hayan abonado. Hasta entonces, la deuda y su fecha de vencimiento no sufrirán modificaciones. No asumimos responsabilidad alguna por la presentación y el protesto puntuales. La gestión del protesto y las comisiones de cobro correrán a cargo del cliente.
- Aunque las disposiciones del comprador sostengan lo contrario, nos asistirá el derecho a cargar los pagos adeudados y contraídos por el cliente con anterioridad, en orden de antigüedad.
- El cliente no está autorizado a retrasar ningún pago o a compensarlo mediante contra reclamaciones impugnadas por nosotros.
- En caso de incumplimiento de las condiciones de pago por parte del cliente (deudor), todas

las deudas pendientes serán exigibles inmediatamente. La demora en el pago por parte del cliente tendrá como consecuencia la retención del suministro con arreglo a las disposiciones adoptadas en el punto 5.

6. Morosidad e insolvencia

- En caso de incumplimiento de los plazos de pago establecidos (demora) o en el caso de notificación de protesto de un cheque, pagaré y/o letra de cambio, tenemos derecho a:

- rescindir todos los contratos y reclamar daños y perjuicios por incumplimiento;
- hacer cumplir nuestra reserva de dominio y tomar posesión de la mercancía suministrada (véase punto 10);
- exigir garantías y liquidar las garantías recibidas;
- declarar vencidos todos los pagos pendientes y efectuar las entregas pendientes contra pago anticipado;
- cargar intereses de demora a partir de la fecha de vencimiento por un total del ocho por ciento sobre el tipo de interés básico establecido por el Banco Central Europeo más los intereses de demora del IVA devengado vigente en el momento;
- cargar cualquier posible daño de demora tras presentar las correspondientes pruebas al cliente.

- En caso de procedimiento judicial o en caso de iniciación de los procedimientos de insolvencia sobre el patrimonio del cliente, no tendrán validez las rebajas, bonificaciones y descuentos concedidos de las facturas pendientes de pago.

7. Plazos de entrega

- Los pedidos recibidos se considerarán aceptados una vez que los hayamos confirmado por escrito. Los plazos y fechas de entrega sólo son aproximados (y pueden estar sujetos al incumplimiento de pagos en curso anteriores). Las fechas y plazos de entrega, que se estipulen con o sin carácter vinculante, se deberán acordar por escrito.
- Los plazos de entrega acordados sin precisar una determinada fecha de entrega comenzarán con la fecha de nuestra confirmación de pedido. Se considerará que se han respetado los plazos y fechas de entrega si, antes de que el plazo expire, la mercancía sale del lugar de expedición o se notifica que está lista para el envío.
- A pesar de nuestros derechos por demora del cliente, los plazos y fechas de entrega se prorrogarán por el período de tiempo que el cliente esté en mora con sus obligaciones derivadas del presente u otro acuerdo.
- En caso de que incurriésemos en demora de entrega, el cliente puede rescindir el contrato una vez que haya expirado el plazo de gracia fijado por él, o puede pedir daños y perjuicios en caso de constatación de daños en los que concurren dolo o negligencia grave por nuestra parte, limitándose, no obstante, a costes adicionales por efectuar una compra de cobertura. No se aplican otros derechos. Queda especialmente excluida la responsabilidad por negligencia leve. La limitación de responsabilidad por negligencia leve no se aplicará en caso de daños físicos y daños para la salud imputables a nosotros, o en caso de fallecimiento del cliente.
- Se entiende que podrán realizarse entregas parciales, a no ser que se excluya expresamente y por escrito .Para el pago de entregas parciales, se aplicará el punto 4 de las presentes condiciones generales de pago y entrega.

8. Condiciones de envío

- Los riesgos por pérdida o deterioro casual de la mercancía pasarán con la entrega de la mercancía al cliente. En caso de envío, pasarán con la entrega del producto al expedidor, al transportista o a la persona o agencia encargada de realizar el envío. El envío se realiza principalmente ex fábrica, en tanto no se haya acordado otra cosa.
- Si se acuerda entrega gratuita, los riesgos por pérdida o deterioro casual de la mercancía/objeto vendido pasará con la llegada del vehículo frente a la dirección de entrega, a la planta baja o a un lugar que sea razonablemente accesible con el vehículo. Nuestro cliente estará obligado, en la medida que sea técnicamente posible, a proporcionar empleados o los equipos necesarios para la descarga.
- Se plantearían las mismas consecuencias si el cliente estuviese en mora de aceptación.
- Si la mercancía estuviese lista para su envío y se retrasase la recepción o el envío por motivos no imputables a nosotros, los riesgos pasarán al cliente con la recepción de la notificación de la disponibilidad de envío. Los suministros listos para su envío deben ser aceptados inmediatamente a más tardar en un plazo de cinco (5) días hábiles a partir de la fecha de notificación de la disponibilidad de envío. De lo contrario, tenemos derecho a enviar el material según nuestro criterio. Si la carga o el transporte de la mercancía se retrasase por motivos no imputables a nosotros, tenemos el derecho pero no la obligación de almacenar, según nuestro criterio, la mercancía por cuenta y riesgo del comprador y con exclusión de nuestra responsabilidad, y de cargar al cliente los costes derivados, tomar todas las medidas que consideremos oportunas para la conservación de la mercancía y a facturar la mercancía como entregada.
- Si no hay indicaciones específicas para el envío, este se realizará, según nuestro criterio pero sin nuestra responsabilidad, por el método de envío más barato. Tenemos derecho a suscribir un seguro de transporte y de rotura de mercancías que correrá a cargo del cliente. En el plazo de dos semanas se deberán notificar las reclamaciones por daños, y confirmar por escrito aportando evidencias de la naturaleza y alcance de los daños. Esta responsabilidad pasará al cliente con la entrega de la mercancía al expedidor o transportista, y a más tardar con su salida de fábrica o del almacén. Esto también se aplicará si la entrega se realizase con nuestros propios vehículos.
- La devolución de la mercancía suministrada por nosotros se realizará a portes pagados sólo si se encuentra en perfecto estado o si hay un acuerdo previo. Si se admite voluntariamente la devolución de la mercancía, ésta se acreditará en función de su estado menos una parte del coste de al menos el Ventie por ciento (20%) del valor de la mercancía devuelta. El crédito se realizará tras la recepción

y comprobación de la mercancía en nuestras instalaciones. Se excluye la devolución de ejecuciones especiales o mercancías suministradas especialmente de acuerdo con las especificaciones del cliente.

9. Responsabilidad por defectos

Ofrecemos una garantía contra mercancía defectuosa, incluida la falta de calidad garantizada de acuerdo con las siguientes especificaciones:

- Nuestra garantía se refiere a una ejecución y uso adecuados de materiales en buen estado. No se asumirá ninguna garantía por daños causados por desgaste natural, carga excesiva y una instalación inadecuada.
- Una vez que el cliente ha recibido la entrega de la mercancía en la forma prescrita en el contrato, quedará excluido el derecho a dar aviso de cualquier defecto que pudiera haber sido descubierto durante el proceso de entrega estipulado en el contrato.
- Para las legítimas reclamaciones por defectos, garantizamos su reparación o sustitución, según nuestro criterio.
- En caso de fallar el cumplimiento posterior, el cliente puede exigir según su elección una rebaja de la remuneración (reducción) o la cancelación del contrato (rescisión). En caso de infracción leve del contrato y especialmente en caso de defectos leves, al cliente no le corresponde ningún derecho de rescisión.
- El derecho a reclamaciones exige el correcto cumplimiento por parte del cliente de sus obligaciones de revisión y notificación según el Código de Comercio español, y R.D. Legislativo 1/2007 de 16 de noviembre especialmente los artículos 128 a 146. El cliente está obligado a probar el cumplimiento de la totalidad de los requisitos de reclamación, en particular el defecto mismo, el momento de la constatación del defecto y la notificación del defecto dentro de los plazos. Esto también se aplica a reclamaciones en relación con la cantidad, dimensiones y peso de las piezas.
- Si, como consecuencia de vicios jurídicos y materiales tras un fallido cumplimiento posterior, el cliente opta por la rescisión del contrato, no tendrá derecho a reclamar daños y perjuicios por el defecto. Si, tras un fallido cumplimiento posterior, el cliente opta por reclamar daños y perjuicios, la mercancía permanecerá en las instalaciones del cliente siempre y cuando sea razonable para él. La indemnización por daños y perjuicios se limitará a la diferencia entre el precio de compra y el valor de la mercancía defectuosa. Esto no será aplicable, si de manera fraudulenta hubiésemos provocado el incumplimiento del contrato.
- El plazo para las reclamaciones de garantía es de un año a partir del suministro de la mercancía. Esto no se aplicará, si el cliente no nos notifica el defecto dentro del plazo (véase apartado 5 de esta disposición).
- En cuanto a la naturaleza y características de la mercancía, en principio, se tendrá en cuenta la descripción del producto del fabricante. Las declaraciones públicas, propaganda o publicidad del fabricante no equivalen a informaciones sobre características esenciales de la mercancía de carácter contractual.
- Si el cliente recibe instrucciones de montaje o documentación técnica defectuosas, estamos obligados únicamente a suministrar unas instrucciones de montaje o documentación técnica correctas, y sólo si esta deficiencia impidiese un montaje correcto o un uso contractualmente correcto de la pieza de trabajo.
- El cliente no recibe, por parte nuestra, garantías en sentido jurídico. Las garantías del fabricante no se verán por ello afectadas.

10. Limitaciones de responsabilidad

- En el caso de incumplimiento de obligaciones por negligencia leve, nuestra responsabilidad se limita al daño medio previsible, contractual e inmediato según el tipo de material. Esto también es aplicable en el caso de incumplimientos de obligaciones por negligencia leve de nuestros representantes legales o intermediarios. No nos responsabilizamos, en el caso de incumplimientos por negligencia leve, de obligaciones contractuales complementarias.
- Las limitaciones de responsabilidad precedentes no son válidas para las reclamaciones del cliente derivadas de la responsabilidad del producto. Además, las limitaciones de responsabilidad no se aplicarán en caso de daños físicos y daños para la salud no imputables o en caso de fallecimiento del cliente.
- Las reclamaciones de indemnización por daños y perjuicios del cliente a consecuencia de un defecto prescriben al cabo de tres (3) años de la entrega de la mercancía.

11. Control de exportaciones

- El cliente se compromete a recabar información en las autoridades locales del país en el que está establecido sobre las condiciones en las que se debe importar el producto solicitado. El producto se deberá declarar a las autoridades competentes y, en caso de que sea necesario se deberán pagar las tasas aplicables. El cliente deberá comprobar en las autoridades locales las opciones de importación y las posibilidades de uso del producto o los servicios solicitados. El cliente se compromete además a asegurarse de que las características técnicas indicadas por el fabricante se corresponden con los requisitos legales del país en el que se va a realizar la importación.
- Antes de realizar la exportación de las mercancías en las que se instalarán los productos de ROS, el vendedor deberá obtener todos los permisos de exportación necesarios. Asimismo, los productos no se podrán vender ni transmitir directa o indirectamente a empresas, personas o países, en tanto ello atente contra las leyes o regulaciones de control de exportaciones. El comprador no tendrá derecho a devolver las mercancías.
- El cliente no tendrá derecho a devolver las mercancías o a exigir daños y perjuicios si se le niega un permiso de exportación. No asumiremos ninguna responsabilidad en caso de que el cliente viole la ley. El cliente nos eximirá de todos los derechos o sanciones relacionados con los objetos suministrados que haya contra nosotros como consecuencia de infracciones que se hayan cometido contra las leyes de control de exportaciones.

12. Reserva de dominio

- Hasta que se satisfagan todas las exigencias (incluidos los balances de cuentas corrientes), que nos corresponden ahora o en el futuro frente a nuestros clientes por cualquier motivo legal, se nos

conceden las garantías reguladas en los siguientes párrafos 2 a 9. A petición del cliente, cederemos las garantías a nuestra discreción y siempre que su valor no supere en más de un diez por ciento (10%) el de nuestras exigencias.

- La mercancía seguirá siendo de nuestra propiedad. El tratamiento y elaboración será siempre realizado por nosotros en calidad de fabricante, aunque sin ninguna obligación por parte nuestra. Si nuestra (co-)propiedad se extinguiese mediante fusión o asociación, desde ese mismo momento se acordará la transmisión de la (co-)propiedad del cliente sobre el objeto unificado de manera proporcional a su valor (valor de la factura).
- El cliente ostentará nuestra (co-)propiedad gratuitamente. La mercancía que nos corresponde en (co-)propiedad, se denominará en lo sucesivo mercancía reservada.
- Nuestro cliente tiene derecho a procesar y a vender la mercancía reservada dentro del marco habitual de su negocio. Las exigencias (incluidas todas las exigencias de saldo de cuentas corrientes) derivadas de la venta ulterior, elaboración o de cualquier otra razón legal (seguro, acto ilícito) con respecto a la mercancía reservada serán cedidas a nosotros por el cliente en su totalidad. Aceptaremos la cesión. Ninguno de nuestros derechos de reserva de dominio (reserva de cuenta corriente simple, ampliada o extendida) expirará aunque la mercancía entregada por nosotros haya sido adquirida por otro comprador, en tanto en cuanto no se haya satisfecho el pago de la mercancía. Esto se aplica especialmente en el caso de venta en el marco de empresas vinculadas.
- Autorizamos al cliente de forma revocable a cobrar por nuestra cuenta y en nombre propio las exigencias que se nos ha cedido. Nos reservamos el derecho de cobrar nosotros mismos las exigencias si el cliente no cumple debidamente con sus obligaciones de pago, incurre en mora o existe una solicitud de apertura de un proceso de insolvencia o cesación de pagos. Si este fuese el caso, podríamos exigir al cliente que nos notificase las exigencias cedidas, indicase todos los datos necesarios para el cobro, entregase la documentación correspondiente y comunicase a los deudores (terceras partes) la cesión.
- En caso de acceso de terceros a la mercancía reservada, el cliente deberá poner en conocimiento nuestra titularidad.
- A modo de garantía de nuestras exigencias, el cliente nos cederá también las garantías que le corresponden que se deriven de la unión frente a un tercero de la mercancía con un bien inmueble.
- El cliente tiene la obligación de comunicarnos inmediatamente el acceso de un tercero a la mercancía, especialmente en el caso de embargo, de posibles daños o de destrucción de la mercancía. Si la tercera parte no está en condiciones de compensar los gastos judiciales y extrajudiciales de un procedimiento judicial con arreglo al art 394 LEC, el cliente responderá de las pérdidas sufridas. El cliente deberá notificarnos inmediatamente el cambio de propiedad de la mercancía así como cualquier cambio de dirección.
- En el caso de que el cliente muestre un comportamiento contrario al contrato, especialmente en el caso de demora de pago, estamos autorizados a retirar la mercancía reservada y en caso necesario, exigir la cesión de los derechos de restitución de nuestro cliente frente a terceros. Ni la retirada o el embargo de la mercancía reservada por parte nuestra constituirán una rescisión del contrato.
- A petición nuestra, el cliente está obligado a revelar quién es su comprador, comunicarle la cesión, facilitamos la información necesaria para hacer valer nuestros derechos frente al comprador y entregar la documentación necesaria. Además, tenemos derecho a notificar al comprador de nuestro cliente la cesión.
- En el caso de haber acordado con el cliente pagos de la deuda del precio de compra según el procedimiento de cheque/pagaré/ letra de cambio, la reserva se extenderá también al cobro de la letra de cambio aceptada por nosotros por parte del empresario y no expirará con el abono del cheque recibido por nosotros.
- El cliente está obligado a tratar la mercancía con cuidado. Si fuesen necesarios trabajos de mantenimiento e inspección, el cliente los deberá realizar a tiempo y correrá con los gastos derivados de ello. A petición nuestra, se nos debe facilitar en todo momento un inventario y una identificación suficiente de la mercancía reservada en el lugar de almacenamiento correspondiente.

13. Prescripción

Nuestros derechos a indemnización por la entrega de bienes muebles que han de fabricarse y producirse prescriben al cabo de cinco (5) años.

14. Disposiciones finales

- El cliente sólo podrá transmitir a un tercero los derechos y obligaciones resultantes de este contrato con nuestro consentimiento previo por escrito.
- El lugar de cumplimiento para el suministro y para pagos es Sant Jaume de Llierca (Girona, España).
- El tribunal o juzgado competente será el correspondiente a la sede de nuestra empresa, siempre y cuando el cliente sea un comerciante, persona jurídica de derecho público o un patrimonio de derecho público. Esto mismo se aplicará si el cliente no dispusiese de ninguna jurisdicción general o si, en la fecha de la interposición del recurso, no se conociese su domicilio o residencia habitual. Asimismo, tenemos derecho a demandar ante un tribunal que corresponda a la sede o a una filial del demandante.
- Se aplicará el derecho español para estas condiciones de entrega y de pago, y para todas las relaciones jurídicas existentes entre nosotros y nuestro cliente. No serán aplicables las disposiciones de la CISG (Convención de las Naciones Unidas sobre los Contratos de Compraventa Internacional de Mercaderías).
- El cliente reconoce que no se vulnerarán derechos de terceros a través de su pedido.
- En el caso de que hayamos proporcionado una garantía de fiel cumplimiento, el comprador o cliente no podrá recurrir a ella a primer requerimiento. Un reclamo de beneficios sólo se llevará a cabo después y con la presentación del correspondiente laudo arbitral.
- Si algunas de las cláusulas del contrato contraído con el cliente incluidas las presentes condiciones de entrega y pago resultan o resultasen total o parcialmente inválidas, ello no afectaría a la validez del resto de las cláusulas. La disposición total o parcialmente inválida deberá ser sustituida por una disposición cuyo efecto económico se aproxime lo más posible al de la regulación invalidada.



GENERAL TERMS AND CONDITIONS



1 General aspects, area of validity

1. Our general delivery and payment terms apply to companies as defined under Art. 1 of the Commercial Code (22/8/1885) and Law 7/1998 of 13 April. Entrepreneurs, in this sense, are any natural person or legal entity or incorporated business partnership with whom we enter into a business relationship and who acts in a corporate capacity or as a self-employed professional.
2. The following terms apply to all our offers and deliveries. They apply to all current and future business relations, even if they are not explicitly agreed upon.
3. The customer's purchase terms are not part of the contract. They are not accepted if, after receipt, we explicitly object to them. At the latest on receipt of the goods and the services supplied by us, our general delivery and payment terms are deemed as accepted. Varying agreements are only binding if we acknowledge them in writing.
4. The rights arising from this contract cannot be transferred to another party.

2 Guarantees of the contract

1. All our offers, whether made verbally or in writing, are subject to confirmation and are non-binding. They do not constitute an obligation to deliver. With the purchase order acknowledgement, the customer declares with binding effect that they want to place the order or to purchase the goods. We reserve the right to accept the contractual offer included in the order within two (2) weeks of receipt. The acceptance can be declared either in writing or through delivery to the customer of the goods. Our purchase order acknowledgement determines exclusively the scope of the contractually due service.
2. Conclusions of transactions through representatives are binding for the customer but shall only be valid with a written acknowledgment by us.
3. We reserve sole ownership and copyright to any documents which belong to the offer. Without our prior agreement, these documents may not be distributed to third parties. If the order is not placed, the documents have to be returned to us upon our request and destroyed. Prices of individual sales positions are only valid as part of the total offer. Drawings, images, measurements, weights and other service data only have a binding effect if this is explicitly agreed in writing.
4. When the customer orders the goods electronically, we will immediately acknowledge the receipt of the order. The notification of order receipt is not yet an acceptance with binding effect of the order. The notification of order receipt can be combined with the notification of acceptance. If the customer orders the goods by electronic means, we save the contract text, and upon request, it will be sent by e-mail to the customer in addition to the present general delivery and payment terms.
5. We reserve the right to make changes of type of construction, material selection, specifications and design even after sending a notification of order acceptance provided that those modifications do not contradict the notification of order acceptance or the specifications of the customer. The customer will agree to the proposed modifications if they find them reasonable.

3 Tolerances

In order to fulfil the dimensional features of our products, tolerances apply. Unless we, as suppliers, explicitly state otherwise, we manufacture within our standard range tolerances.

4 Pricing

1. Our prices result from the notification of order acceptance. Our prices are in Euros per unit with the goods located in our warehouses in Sant Jaume de Llierca (Girona, Spain), excluding packing, shipping and other transportation costs, and tariff-free (foreign countries).
2. If between closing of contract and the delivery or service there is an increase in the prices of our suppliers, our costs (e.g. freight, wages and raw material, etc.) or our taxes, or other new taxes are introduced, we are entitled to increase our price accordingly, except when the price is explicitly confirmed as a fixed price.
3. If we consider a request for a modification by a customer, we are entitled to charge the customer for the resulting extra costs.
4. The customer will be charged with value-added tax, pursuant to statutory regulations. Any increases in the value-added tax rate between the time of placing the order and delivery are borne by the customer.

5 Payment terms

1. Our deliveries are due for payment (without any deduction) within THIRTY (30) calendar days of receipt. After this stated payment period, the customer is in default.
2. Granting a discount needs a formal individual contract - and additionally as a further requirement - that by then all outstanding invoices are settled. For the discount calculation, the net invoice amount (after deduction of abatements, freight charges and other costs passed on to third parties) is decisive.
3. We are not obliged to accept bills of exchange, promissory notes, cheques or confirming. We accept bills of exchange only when subject to a discount option. Cheques, promissory notes and bills of exchange will be first credited after check encashment, and assignments of debt will be first credited after payment. Until then, the amount receivable and its payment due dates remain unchanged. No liability is accepted for prompt presentation or protest. Protest and collection charges will be borne by the customer.
4. When applicable, we are entitled to impute payments first to earlier debts of a customer despite contrary terms of this customer.
5. The retention of payments or the offsetting of possible customer counterclaims - contested by us - will be not allowed.
6. In case of the customer's (debtor's) failure to comply with the terms of payment, all outstanding debts will become immediately due. The customer's payment default is subject to detention of the goods, pursuant to the stipulations of the following § 5.

6 Default and credit unworthiness

1. After expiry of the agreed payment deadlines (default) or receipt of cheque, promissory note and/or bill of exchange protest, we are entitled to

- withdraw from all contracts and demand damages due to the failure to fulfil obligations
- exercise our retention of title and take possession of the goods delivered (cf. § 10 below)
- demand collateral and use the collateral demanded
- declare all unpaid accounts due and deliver only against prepayment
- charge default interest, starting from the due date, in an amount of eight percent above the basic interest rate of the European Central Bank, plus entitlement to charge the accruing default interest of the current value-added tax
- charge any further possible default damage after submitting appropriate evidence to the customer.

2. In case of judicial enforcement or in case of filing a bankruptcy proceeding in regards of the assets of the customer, all rebates, bonuses and discounts granted on unpaid bills shall not be valid.

7 Delivery deadlines

1. Received orders are only considered as accepted after issuance of our written notification of acknowledgement. The delivery dates and delivery times are just approximate times (and may be subject to previous outstanding non-payments). Delivery dates and delivery times, which can be stipulated with and without binding effect, have to be made in writing.
2. Delivery times that are not part of a fixed delivery date start with the date of our notification of order acknowledgement. Delivery times and delivery dates are considered as fulfilled when the goods are shipped or when readiness for shipment is communicated within the deadline.
3. Delivery times and delivery dates are extended for the length of the time for which the customer is in default towards us with this or other orders pursuant to their obligations, notwithstanding our other rights concerning the customer default.
4. If we are the cause of the delivery delay, the customer may withdraw from the contract after an appropriate respite time has passed, set by the customer, or may request damages if the damage involves gross negligence or intentional damage on our part. However, the customer is restricted to the extra costs for a substitute purchase. Further claims do not apply. Liability for minor negligence is particularly precluded. Liability limitation for minor negligence does not apply in case of injury to body or health attributable to us or loss of the customer's life.
5. It is agreed that partial deliveries may be made, except when it is explicitly excluded in writing. For the payment of partial deliveries, § 4 of these general delivery and payment terms applies.

8 Shipping terms

1. The risk of accidental loss or accidental deterioration of the goods passes to the customer with delivery of the goods. In the event of shipment, with the delivery of the product it passes to the carrier or the hauler or any other person or agent in charge of carrying out the shipment. The shipping takes place mainly ex works - unless otherwise agreed.
2. If free delivery is agreed, the risks of accidental loss or accidental deterioration of the goods/item sold passes on with arrival of the vehicle in front of the delivery address, on the ground floor or at a spot which is reasonably accessible for the vehicle. Our customer is obliged to provide necessary equipment or workers for unloading, in so far as this is technically possible.
3. The handover is the same if the customer is in default of acceptance.
4. If the goods are ready for shipment but the receipt or the shipment is delayed, and we are not the cause, the risks pass to the customer with receipt of the shipping readiness notification. Supplies ready for shipping have to be immediately accepted, at the latest within a period of five (5) weekdays after the notification date of shipment readiness. We are otherwise entitled to ship the goods as per our own criteria. If the shipment or transportation of the goods should be delayed for reasons not attributable to us, we are entitled but not obliged to store the goods at our own discretion at the expense and risk of the customer and under exclusion of our liability and to pass the resulting costs to the customer. We are also entitled to take appropriate measures for the preservation of the goods and to charge the goods as delivered.
5. Without specific shipping instructions, we select, to the best of our ability but without liability, the most affordable shipping method. We are entitled to purchase, at the expense of the customer, a transport and breakage insurance. Damage claims have to be notified within a period of two weeks. They must be confirmed in writing, and evidence of their nature and scope has to be provided. With handover of the goods to the carrier or hauler, this responsibility is passed on to the customer, at the latest with goods departure from the factory or the storage facility. This will be applied even if the delivery is made using our own vehicles.
6. Our delivered goods can be only returned free of transportation charges when they are in perfect condition or after our prior agreement. Voluntarily accepted returned goods will be credited, in accordance with their condition minus a share of costs of at least twenty percent (20 %) of the value of the returned goods. The credit takes place after the goods have been received and inspected in our facility. A return of custom-made goods or goods supplied especially according to customer specifications is excluded.

9 Responsibility for defects

We provide a warranty for defective products including the lack of guaranteed quality, pursuant to the following requirements:

1. Our warranty refers to proper execution and usage of faultless materials. The warranty does not cover damage caused by natural wear and tear, excessive use and improper installation.

2. After receipt by the customer of goods delivery as specified in the contract, the allegation of defects, which are found during the delivery process as stipulated in the contract, is excluded.
3. We guarantee repair or replacement, at our discretion, for legitimate claims for defects.
4. If the subsequent performance fails, the customer can choose between a price reduction and cancellation of the contract. In the event of a minor contract violation, especially if it is a minor defect, the customer is not entitled to cancel the contract.
5. Customer claims require that they complied properly with their inspection and notification obligations, pursuant to the Spanish Commercial Code, and Legislative R.D. 1/2007 of 16 November, especially Articles 128 to 146. The customer must accept the full burden of proof for all claim requirements, particularly for the defect as such, for the time of the defect detection and for the timely notification of the defect.
- The same also applies to claims regarding the quantities, dimensions and weight of the parts.
6. If the customer chooses a rescission of the contract - after failed subsequent performance - by reason of a legal or material deficiency, they are not entitled to a claim for damages due to defect. If the customer chooses to claim damages after a failed subsequent performance, the goods shall stay in the customer's facilities, in so far as they deem this to be reasonable. The damages shall be limited to the difference between the purchase price and the value of the defective goods. This shall not apply if we caused the contract violation maliciously.
7. The warranty period is one year after delivery of the goods. This shall not apply when the customer did not notify us in a timely manner about the deficiency (cf. paragraph 6. of this provision).
8. With regard to the nature and characteristics of the goods, as a principle, only the product description of the manufacturer is agreed upon and takes effect. Public statements, promotions or advertisements of the manufacturer are not contractual statements on the essential characteristics of the goods.
9. If the customer receives a deficient assembly instruction or a deficient technical documentation, we are only obliged to supply an assembly instruction or technical documentation which is free of any deficiency, and only when the deficiency causes problems for proper assembly or the contractual usage of the part.
10. The customer does not receive legal guaranties from us. Manufacturer's warranties remain unaffected.

10 Liability limitations

1. In the event of a breach of duty due to minor negligence, our liability is limited to the foreseeable, contractual and average direct damage according to the kind of material. This also applies to the breach of duty due to minor negligence by our legal representatives or intermediaries. We are not liable in case of violations of complementary contractual obligations due to minor negligence.
2. The above liability limitations do not apply to the customer claims for product liability. Liability limitations do not apply in case of non-attributable physical and health damage or the customer's loss of life.
3. The customer's claims for damages due to a defect expire three (3) years after delivery of the goods.

11 Export controls

1. Customers are obliged to ascertain, from the local authorities of the country in which they are resident, information on the conditions under which the ordered item must be imported. The product must be declared to the competent authorities and, if necessary, any accruing fees and charges must be paid. The customer must check the import options and possibilities of use of the products or services requested with the local authorities. The customer is further obliged to ensure that the technical characteristics specified by the manufacturer comply with the legal requirements of the country into which the products or services are going to be imported.
2. Before the export of goods in which ROS products are installed, the seller shall obtain all required export licences and shall not sell or pass on the products, whether directly or indirectly, to companies, persons or countries if this violates export control laws or regulations. The buyer shall not be entitled to return the goods.
3. The customer shall not be entitled to return the goods or to demand compensation if they are denied an export licence. We are not liable for any violation of the law on the part of the customer. The customer shall exempt us from any claims or other penalties against us arising from violation of export control laws in connection with the delivered items.

12 Retention of title

1. Pending the fulfilment of all accounts receivable (including the balance of the current account) to which we are entitled against the customer legally for any reasons now or in the future, we will be granted the guarantees regulated in the following paragraphs 2 through 9. At the customer's request, we will assign the guarantees at our own discretion as long as their value does not exceed our accounts receivable by more than ten percent (10%).
2. The goods will remain our property, and the workmanship and processing shall always be conducted by us as the manufacturer but without our obligation. Should our (joint) ownership expire due to association or merger, it is agreed that the (joint) ownership of the object by the customer shall be transmitted proportionally with its value (invoice value).
3. The customer shall hold our (joint) property free of charge. Goods in relation to which we are entitled to (joint) ownership are described below as retained goods.

4. Our customer is entitled to process and sell retained goods in the course of appropriate business. The customer assigns the full amount of the accounts receivable at closure of the contract to us. This results from the re-sale, processing or any other legal reason (insurance, tort) of the retained goods (including all accounts receivable from the current account balance). We shall accept the assignment. None of our property rights (simple, expanded, extended open account title) shall expire, even if the goods, which were delivered by us, were purchased by another buyer, and as long as they did not pay us for the goods. This applies particularly to sales in the scope of affiliated companies.
5. We revocably authorize the customer to collect the accounts receivable assigned to us in their own name but for our account. We reserve the right to collect the accounts receivable ourselves if the customer does not properly keep up with their payment obligations, if they incur default or file a request for opening of a bankruptcy proceeding or if they cease payments. If this should be the case, we may demand that the customer notifies the assigned accounts receivable and all necessary information for collection purposes to us and that they hand over the corresponding documents to us and inform the debtor (third parties) about the transfer.
6. In case of access by third parties to the retained goods, the customer must make them aware of our property rights.
7. The customer shall also surrender to us - for the security of our accounts receivable - the guarantees to which they are entitled, in relation to a third party, which result from the connection of the goods to a property.
8. The customer is obliged to notify us immediately about third party access to the goods, especially in the event of a seizure as well in case of possible damage or destruction of the goods. If the third party is unable to pay the judicial and extrajudicial costs of legal proceedings, pursuant to Art. 394 LEC (Civil Procedure Act), the customer will be liable to pay for the loss incurred. The customer must notify us immediately in case of transfer of the good to another owner as well as any change of their own address.
9. In case of breach of contract by the customer - particularly default - we are authorized to take the retained goods back and to demand, if necessary, the surrender of claims by our customer against third parties. The removal as well as the seizure of the retained goods by us is not a rescission of the contract.
10. At our request, the customer is obliged to name its buyers to us, to inform them about the assignment, to inform us about the necessary data for entitlement of our rights against the buyers and to hand over the necessary documents. We are also entitled to notify the buyers of our customers about the assignment.
11. If we stipulate with the customer payments of the purchase price debt based on the check/promissory note/bill of exchange procedure, the retention of title clause also extends to the encashment of the bill of exchange accepted by us by the company and does not expire with the payment of the cheque received by us.
12. The customer is obliged to handle the goods with care. As far as maintenance and inspection work is necessary, the customer must exercise this on time and at their own expense. At our request at any time, an inventory and sufficient identification of the retained goods in the respective storage location should be made available to us.

13 Expiration

Our claims of compensation for delivery of moveable property to be manufactured and produced expire after five (5) years.

14 Final provisions

1. The transfer of rights and obligations of the customer from this contract to a third party needs our prior written consent.
2. Place of delivery and payment is Sant Jaume de Llierca (Girona, Spain).
3. The appropriate court corresponding to our company headquarters has the legal jurisdiction if the customer is a merchant, a legal identity under public law or assets under public law. The same shall apply if the customer has no general place of jurisdiction or if its location or habitual residency at the time of commencement of legal proceedings are not known. We are also entitled to file commencement for legal proceedings before a court which has jurisdiction over the location or branch of the plaintiff.
4. For these delivery and payment terms and all legal relationships between us and our customer, Spanish laws shall apply. The provisions of the CISG (United Nations Convention on Contracts for the International Sale of Goods) shall not apply.
5. The customer acknowledges that no rights of third parties shall be violated through its order.
6. If we provided a performance guarantee, the buyer or customer is not entitled to use it upon first demand. A claim for benefits shall follow only after and under submission of an appropriate arbitration award.
7. Should individual provisions of this contract with the customer, including these general delivery and payment terms, be or become totally or partially invalid, this shall not affect the validity of the remaining provisions. The provision which is invalid, whether in part or in its entirety, must be replaced by a provision whose economic effect will be as close as possible to the effect intended by the invalid provision.

CONDITIONS GÉNÉRALES DE VENTE

1 Généralités, champ d’application

- Nos conditions générales de paiement et de livraison s’appliquent aux sociétés conformément à l’article 1 du Code de commerce (22/8/1885) et à la loi 7/1998 du 13 avril. À cet effet, un entrepreneur doit être entendu comme toute personne physique ou morale ou entreprise individuelle ayant la capacité d’agir avec laquelle une relation commerciale est établie et qui exerce une activité professionnelle commerciale ou pour son propre compte.
- Les conditions mentionnées ci-après sont valables pour l’ensemble de nos offres et livraisons. Elles s’appliquent à toutes les relations commerciales présentes et futures, même si elles ne sont pas explicitement convenues à nouveau.
- Les conditions d’achat du client ne font pas partie du contrat. Elles ne sont pas non plus reconnues par notre société si, après réception, nous nous y opposons expressément. Nos conditions générales de paiement et de livraison sont considérées comme acceptées au plus tard à la réception des marchandises et des services fournis par nous. Les modifications de ces conditions ne sont valables que si elles sont convenues par écrit.
- Les droits résultant du présent contrat sont incessibles.

2 Garanties du contrat

- Toutes nos offres, soumises par écrit ou oralement, sont sujettes à confirmation et ne sont pas contraignantes, autrement dit, elles ne nous engageant pas à effectuer la livraison. Par la confirmation de la commande, le client déclare de manière contraignante vouloir acquérir les articles commandés ou vouloir passer la commande. Nous nous réservons le droit d’accepter l’offre contractuelle incluse dans la commande dans les deux (2) semaines suivant sa réception. L’acceptation peut être communiquée au client soit par écrit, soit par la livraison de la marchandise. Seule notre confirmation de commande fait foi pour l’étendue de la prestation contractuelle à fournir.
- Les contrats conclus avec les représentants sont contraignants pour les clients, mais ils ne seront valables qu’après avoir été confirmés par nous par écrit.
- Nous nous réservons les droits de propriété et d’auteur sur les documents faisant partie de l’offre. Ces documents ne doivent pas être cédés à des tiers sans notre autorisation préalable. Si la commande n’est pas passée, ces documents doivent nous être restitués si nous en faisons la demande ou détruits. Les prix de chacun des articles de l’offre ne seront considérés comme valables qu’après la passation de la commande complète de ladite offre. Les dessins, photos, dimensions, poids et toutes autres données faisant référence à nos services ne sont contraignants que si cela a été expressément convenu par écrit.
- Si le client commande la marchandise par voie électronique, nous confirmerons la réception de la commande sans délai. Mais la confirmation de la réception de la commande ne représente pas encore une acceptation contraignante de la commande. La confirmation de réception peut être liée à la confirmation de l’acceptation. Si le client commande la marchandise par voie électronique, nous enregistrons le texte du contrat et nous l’envoyons par courriel au client sur simple demande en y joignant les présentes conditions.
- Nous nous réservons le droit de modifier la conception, le choix des matériaux, les spécifications et le type de fabrication, même après avoir envoyé la confirmation de la commande, à condition que ces modifications ne soient incompatibles ni avec la confirmation de la commande, ni avec les spécifications du client. En outre, le client doit donner son accord concernant les modifications proposées, dans la mesure où elles lui conviennent.

3 Tolérances

Des tolérances sont définies pour la conformité des caractéristiques dimensionnelles de nos produits. Sauf indication contraire de notre part en tant que fournisseur, nous fabriquons conformément à nos tolérances standard.

4 Prix

- Nos prix sont indiqués dans la confirmation de la commande. Ils sont entendus en euros/unité, départ usine, autrement dit depuis nos entrepôts de Sant Jaume de Llierca (Géronne) (Espagne), frais d’emballage, d’expédition, de port et droits de douane (pour l’étranger) non compris.
- Si entre la signature du contrat et la livraison ou la prestation du service, les prix de nos fournisseurs, ainsi que nos coûts (par exemple, augmentations des prix du fret, augmentations de salaires ou du prix des matières premières) ou nos taxes augmentent ou si de nouveaux frais se produisent, nous sommes en droit d’augmenter le prix en conséquence, à moins que le prix n’ait été expressément fixé.
- Si nous tenons compte des propositions de modification du client, nous sommes en droit de facturer au client les coûts supplémentaires qui en résultent.
- La T.V.A. est facturée conformément aux dispositions légales en vigueur. Toute augmentation du taux de T.V.A. entre le moment de la commande et la livraison est à la charge du client.

5 Conditions de paiement

- Le paiement de nos fournitures doit être effectué, sans aucune déduction, dans les TRENTE (30) jours civils suivant leur réception, après quoi le client sera considéré en retard de paiement.
- Outre un accord individuel exprés, il est exigé comme condition supplémentaire pour concéder des réductions que toutes les factures antérieures à la date aient été réglées. Pour le calcul de la remise, le montant net de la facture est déterminant, après déduction des escomptes, des frais de port et d’autres coûts à répercuter à des tiers.
- Nous ne sommes pas tenus d’accepter des traites, des billets à ordre, des chèques ou du confirm- ing (reverse factoring). Nous n’acceptons les traites que sous réserve d'une possibilité d’escompte. Les chèques et les traites ne sont crédités au client qu’après encaissement en espèces et les cessions de créances ne sont créditées qu’une fois le paiement effectué. Avant l’encaissement ou le paiement, la créance et son exigibilité ne seront en rien modifiées. Nous n’assumons aucune responsabilité en cas de présentation o de protêt ponctuels. La gestion du protêt et les commissions de recouvrement sont à la charge du client.
- Malgré des dispositions éventuellement divergentes du client, nous sommes en droit de réclamer les factures impayées contractées par le client auparavant, par ordre d’ancienneté.
- Le client n’est pas en droit de retenir des paiements ou de les compenser par la présentation de récla-

mations que nous aurions contestées.

6. En cas de non-respect des conditions de paiement par le client (débiteur), toutes les créances restant dues seront exigibles immédiatement. Conformément aux dispositions convenues au § 5, le retard de paiement du client entraîne la rétention de la fourniture.

6 Retard de paiement et insolvabilité

1. En cas de dépassement des délais de paiement convenus (retard de paiement) ou en cas de notification de protêt de chèques et/ou de traites, nous sommes en droit de :

- résilier tous les contrats et d’exiger des dommages et intérêts pour non-exécution ;
- de faire valoir notre réserve de propriété et de reprendre possession de la marchandise fournie (cf. § 10 ci-après) ;
- d’exiger des garanties et d’exécuter les garanties reçues ;
- d’exiger le paiement de toutes les factures restant dues et de n’effectuer les livraisons restant dues que contre paiement anticipé ;
- à compter de la date d’échéance, de facturer des intérêts de retard d’un montant de huit pour cent sur le taux d’intérêts de base de la Banque centrale européenne, plus les intérêts de retard de la T.V.A. exigible en vigueur à ce momen””” là ;
- le cas échéant, de réclamer au client des intérêts de retard supplémentaires sur présentation des justificatifs correspondants.

2. En cas de procédure judiciaire ou d’ouverture d’une procédure d’insolvabilité à l’encontre du patrimoine du client, nous tous les rabais, ristournes et remises accordés sur l’ensemble des factures restant dues sont caduques.

7 Délais de livraison

- Les commandes reçues par notre société ne doivent être considérées comme acceptées qu’après notre confirmation écrite. Les délais et les dates de livraison sont toujours donnés à titre indicatif (et peuvent être soumis au paiement de factures impayées précédemment). Les dates et délais de livraison, stipulés avec ou sans contrainte, doivent être convenus par écrit.
- Les délais de livraison convenus sans indication d'une date de livraison précise courent à compter de la date de notre confirmation de commande. Les délais et dates de livraison sont considérés comme respectés si, avant l’expiration du délai, la marchandise quitte le lieu d’expédition ou si notre société notifie au client qu’elle est prête à être expédiée.
- Outre nos droits résultant du retard du client, les délais et dates de livraison peuvent être prolongés tant que le client n’aura pas respecté ses obligations envers notre société découlant du présent contrat ou d’autres contrats.
- Si nous sommes de notre côté en retard de livraison, le client est en droit, après expiration du délai supplémentaire fixé par lui, de résilier le contrat ou encore d’exiger de notre société des dommages et intérêts en cas de dommages intentionnels ou de négligence grave de notre part. Mais ces dommages et intérêts sont limités aux surcoûts encourus pour effectuer un achat afin de se procurer la marchandise. Les autres droits ne sont pas applicables. La responsabilité pour négligence légère est particulièrement exclue. La limitation de responsabilité en cas de négligence légère ne s’applique pas en cas de dommages corporels, d’atteintes à la santé ou de décès du client, étant imputables à notre société.
- Il est convenu que des livraisons partielles sont autorisées, sauf si cela a été expressément exclu par écrit. Pour le règlement de livraisons partielles, le § 4 des présentes conditions générales de paiement et de livraison est applicable.

8 Conditions d’expédition

- Les risques de perte ou de détérioration accidentelle de la marchandise sont transférés au client au moment de la livraison de la marchandise et, en cas d’expédition, au moment de la remise de la marchandise au commissionnaire de transport, au transporteur, à la personne ou à l’agence chargée d’effectuer l’expédition. En principe, l’expédition s’entend départ usine, tant qu’il n’en a pas été convenu autrement. 2. S’il est convenu une livraison franco de port, les risques de perte ou de détérioration accidentelle de la marchandise/de l’objet vendu sont transférés au moment de l’arrivée du véhicule devant l’adresse de livraison, au rez-de-chaussée ou dans un endroit raisonnablement accessible avec le véhicule. Notre client est tenu, dans la mesure où cela est techniquement possible, de mettre à disposition les employés ou les engins nécessaires pour le déchargement.
- Si le client est en retard d’acceptation de la marchandise, ces conditions sont également applicables.
- Si la marchandise est prête à l’expédition et si la réception ou l’expédition est retardée pour des raisons qui ne nous sont pas imputables, les risques sont transférés au client dès réception de la notification de disponibilité de l’expédition. Les fournitures prêtes à l’expédition doivent être acceptées immédiatement au plus tard dans un délai de cinq (5) jours ouvrés suivant la date de notification de disponibilité de l’expédition. Dans le cas contraire, nous sommes en droit d’expédier la marchandise à notre convenance. Si le chargement ou le transport de la marchandise est retardé pour des raisons qui ne nous sont pas imputables, nous sommes en droit, mais non tenus, de stocker la marchandise à notre convenance aux frais et aux risques du client, et ce sans aucune responsabilité de notre part. Les frais ainsi occasionnés seront facturés au client. Nous sommes également en droit de prendre toutes les mesures jugées nécessaires pour la conservation de la marchandise et de facturer la marchandise comme si elle avait été livrée.
- Sans indications précises pour l’expédition, nous l’effectuons à notre convenance, mais sans en assumer la responsabilité, par le mode d’expédition le moins cher. Nous sommes en droit de souscrire une assurance de transport et contre la casse qui sera à la charge du client. Les réclamations pour dommages doivent être notifiées et confirmées par écrit en apportant la preuve de la nature et de l’étendue des dommages dans un délai de deux semaines. Cette responsabilité est transférée au client au moment de la remise de la marchandise au commissionnaire de transport ou au transporteur et, au plus tard, lorsque la marchandise quitte l’usine ou l’entrepôt. Cela s’applique également si la livraison est effectuée par nos propres véhicules.
- Le retour de la marchandise que nous avons fournie doit être effectué franco de port et nous ne l’accepterons que si la marchandise est en parfait état ou sur accord préalable. Si nous acceptons le retour de

la marchandise, nous procéderons à son remboursement en fonction de son état, en déduisant au moins vingt pour cent (20 %) de la valeur de la marchandise retournée. L’avoir sera effectué après la réception et vérification de la marchandise dans nos installations. Le retour de fabrications spéciales ou de marchandi- ses spécialement fournies conformément aux spécifications du client est exclu.

9 Garantie des vices cachés

Nous offrons une garantie contre la marchandise défectueuse, y compris le manquement à la qualité garantie conformément aux dispositions suivantes :

- Notre garantie ne s’applique qu’en cas de montage et d’utilisation corrects de matériaux en bon état. Notre garantie ne couvre aucun dommage causé par l’usure naturelle, la charge excessive et le montage non conforme.
- Une fois que le client a réceptionné la marchandise conformément à ce qui est prévu dans le contrat, ce dernier n’a plus le droit de notifier tout défaut qui aurait pu être découvert au cours du processus de livraison stipulé dans le contrat.
- En cas de réclamations légitimes pour défauts, nous garantissons la réparation des articles ou leur remplacement, selon nos critères.
- En cas de manquement à l’obligation subséquente, le client peut exiger à sa convenance une réduction du prix (remise) ou une annulation du contrat (résiliation). Mais le client n’a aucun droit à la résiliation en cas de faute contractuelle minime et, en particulier, en cas de vices mineurs.
- Le droit à réclamations revenant au client présuppose que ce dernier a respecté correctement ses obligations de vérification et de notification qui lui incombent conformément au Code de commerce espagnol et au décret royal législatif 1/2007 du 16 novembre et notamment aux articles 128 à 146. Le client est tenu de prouver le respect de toutes les exigences concernant la réclamation, en parti- culier le défaut lui-même, le moment de la constatation du défaut et la notification de la réclamation pour défaut dans les délais convenus. Cela vaut également pour les réclamations relatives au nombre de pièces, à leur dimension et à leur poids.
- Si, à la suite de vices légaux et matériels après un manquement à l’obligation subséquente, le client choisit de résilier le contrat, il n’aura pas le droit de réclamer de dommages et intérêts pour le vice. Si, après un manquement à l’obligation subséquente, le client choisit de réclamer des do- mmages et intérêts, la marchandise demeurera dans les locaux du client aussi longtemps que cela sera possible pour lui. L’indemnisation des dommages se limite à la différence entre le prix d’achat et la valeur de la marchandise défectueuse. Cela ne s’applique pas si nous avons occasionné la violation du contrat de façon dolosive.
- Le délai pour les réclamations de vices sous garantie est d'un an à compter de la livraison de la marchandise. Cela ne s’applique pas si le client ne nous a pas notifié le vice dans ce délai (cf. le point 6 de la présente disposition).
- En ce qui concerne la nature et les caractéristiques de la marchandise, en principe, seule la des- cription du produit par le fabricant fait foi. Les déclarations publiques, les réclames ou la publicité du fabricant ne constituent pas des informations sur les caractéristiques essentielles de la marchandise à caractère contractuel.
- Si le client reçoit des instructions de montage ou des documents techniques défectueux, nous sommes uniquement tenus de fournir des instructions de montage ou des documents techniques corrects et ce, seulement dans le cas où cette défaillance empêche un montage correct ou une utilisation contractuellement correcte de la pièce.
- Nous n’accordons pas au client de garanties au sens juridique. Les garanties des fabricants ne sont en rien modifiées par la présente disposition.

10 Limitations de responsabilité

- En cas de léger manquement à nos obligations, notre responsabilité est limitée aux dommages moyens prévisibles, contractuels et immédiats en fonction du type de marchandise. Cela s’applique également en cas de léger manquement aux obligations de nos représentants légaux ou de nos inter- médiaires. En cas de légers manquements aux obligations, nous n’assumons aucune responsabilité concernant des obligations contractuelles complémentaires.
- Les limitations de responsabilité mentionnées ci-dessus ne concernent pas les réclamations du client résultant de la responsabilité du fait du produit défectueux. En outre, les limitations de respon- sabilité ne s’appliquent pas en cas de dommages corporels, d’atteintes à la santé ou de décès du client, qui ne nous sont pas imputables.
- Les réclamations de dommages et intérêts du client résultant d'un vice prescrivent au bout de trois (3) ans à compter de la livraison de la marchandise.

11 Contrôles des exportations

- Le client s’engage à se renseigner auprès des autorités locales du pays dans lequel il est établi afin de connaître les conditions sous lesquelles le produit commandé peut être importé ; le produit doit être déclaré auprès des autorités compétentes et les frais éventuels en découlant doivent être payés. Le client doit contrôler auprès des autorités locales les possibilités d’importation et d’utilisation des produits ou services commandés. Le client s’engage également à s’assurer que les caractéristiques techniques indiquées par le fabricant sont conformes aux dispositions légales du pays d’importation.
- Avant l’exportation des marchandises dans lesquelles seront installés les produits ROS, le vendeur doit obtenir l’ensemble des licences d’exportation nécessaires et s’engage à ne pas vendre ou trans- mettre les produits de façon directe ou indirecte aux entreprises, personnes ou pays en contravention avec les lois ou règlements sur le contrôle des exportations. L’acheteur n’est pas autorisé à retourner les marchandises.
- Le client n’est pas en droit de retourner les marchandises ou de demander des dommages et in- térêts lorsqu’une licence d’exportation lui est refusée. Nous nous dégageons de toute responsabilité en cas de violation de la loi par le client. Le client nous dégage de toute responsabilité vis-à-vis de toute réclamation ou d’autres sanctions existantes à notre encontre en raison de violations du droit relatif aux exportations en rapport avec les biens fournis.



12 Réserve de propriété

- Jusqu’au recouvrement de toutes les créances, (y compris les soldes de comptes courants), qui nous re- viennent vis-à-vis du client pour quelque raison juridique que ce soit, maintenant ou l’avenir, le client nous fournit les sûretés convenues aux paragraphes 2 à 9 ci-après. Sur demande du client, nous accorderons à notre convenance la mainlevée des sûretés dans la mesure où leur valeur ne dépassera pas le montant de nos créances de plus de dix pour cent (10 %).
- Nous restons propriétaires de la marchandise. Le traitement et l’élaboration sont toujours effectués par nous en tant que fabricant, mais sans aucune obligation de notre part. Si notre (co)propriété expire suite à une fusion ou à une association, à partir de ce momen””” là, il est convenu que la (co)propriété du client sur l’objet unitaire sera cédée au prorata de la valeur de la marchandise (valeur de la facture).
- Le client conserve notre (co)propriété gratuitement. La marchandise, dont nous détenons la (co)propriété, est désignée ci-après comme marchandise sous réserve de propriété.
- Notre client est en droit de traiter et de vendre la marchandise sous réserve de propriété dans le cadre de ses activités commerciales ordinaires. Le client nous cède dès maintenant dans leur intégralité les créances (y compris toutes les créances de solde de comptes courants) résultant de la revente, de l’élaboration ou d’un autre motif juridique quelconque (assurance, acte illicite), liées à la marchandise sous réserve de propriété. Nous acceptons cette cession. Aucun de nos droits de réserve de propriété (réserve de propriété simple, élargie, prolongée ou clause de compte courant) n’expire, même si la marchandise que nous avons livrée est achetée par un autre acquéreur, tant que la marchandise n’aura pas été payée à notre société. Cela vaut en particulier pour la vente dans le cadre d’entreprises liées.
- Nous autorisons le client de façon révocable à recouvrer en son nom et pour notre compte les créances qui nous ont été cédées. Nous nous réservons le droit de recouvrer les créances nous-mêmes dès que le client ne remplira pas ses obligations de paiement de façon conforme, s’il est en retard de paiement, si une demande d’ouverture de procédure d’insolvabilité a été déposée ou encore si le client est en cessation de paiements. Si tel est le cas, nous sommes en droit d’exiger que le client nous notifie les créances cédées, nous fournisse toutes les informations nécessaires au recouvrement des créances, nous remette les documents afférents et notifie la cession aux débiteurs (aux tiers).
- En cas d’accès de tiers à la marchandise sous réserve de propriété, le client doit informer les tiers de notre propriété.
- Pour garantir nos créances, le client nous cède également les sûretés qui lui reviennent résultant, vis-à-vis d’un tiers, de l’union de la marchandise avec un bien immeuble.
- Le client est tenu de nous notifier sans délai l’accès d’un tiers à la marchandise, notamment en cas de saisie, de dommages subis par la marchandise ou de sa destruction. Si le tiers n’est pas en mesure de nous rembourser les frais judiciaires et extra-judiciaires occasionnés par une plainte conformément à l’article 394 de la loi de procédure civile, le client sera responsable des pertes que nous aurons subies. Le client doit nous notifier sans délai le changement de propriétaire de la marchandise ainsi que tout changement de domicile.
- En cas de comportement contraire aux dispositions du contrat de la part du client, notamment en cas de retard de paiement, nous sommes en droit de reprendre la marchandise sous réserve de propriété et d’exiger le cas échéant la cession des droits de restitution de notre client vis-à-vis de tiers. La reprise ou la saisie de la marchandise sous réserve de propriété par notre société ne constitue pas une résiliation du contrat.
- Suite à notre demande, le client est tenu de nous communiquer le nom de son acheteur, de lui notifier la cession, de nous fournir les renseignements nécessaires pour faire valoir nos droits vis-à-vis de l’acheteur et de nous remettre les documents afférents. Nous sommes également en droit de notifier la cession à l’acheteur de notre client.
- Si nous convenons avec le client que les paiements de la créance résultant du prix de vente doivent être effectués par chèques et traites, la réserve s’étend également à l’encaissement par l’entrepreneur de la traite que nous avons acceptée et n’expire pas avec le paiement du chèque que nous avons reçu.
- Le client est tenu de traiter la marchandise soigneusement. Dans la mesure où des travaux de maintenance et d’inspection seraient nécessaires, le client doit les effectuer régulièrement à ses frais. Suite à notre demande, il doit nous remettre à tout moment un inventaire et une identification suffisante de la marchandise sous réserve de propriété dans le lieu de stockage correspondant.

13 Prescription

Nos droits à indemnisation pour la livraison de biens meubles à fabriquer et à produire prescrivent au bout de cinq (5) ans.

14 Dispositions finales

- La cession de droits et d’obligations, résultant du présent contrat, du client à un tiers requiert notre autorisation écrite préalable.
- Le lieu d’exécution pour la fourniture et les paiements est Sant Jaume de Llierca (Géronne, Espagne).
- La juridiction compétente est le tribunal correspondant à notre siège social dans la mesure où le client est un commerçant, une personne morale de droit public ou un organisme de droit public. Il en va de même si le client n’a pas de juridiction compétente ou si, à la date du dépôt de la plainte, son domicile ou sa résidence habituelle n’est pas connue. Nous sommes également en droit de déposer une plainte devant un tribunal qui correspond au siège ou à une filiale du demandeur.
- Les présentes conditions de livraison et de paiement, ainsi que la totalité des relations juridiques entre notre société et nos clients sont régies par le droit espagnol. Les dispositions de la CVM (Convention des Nations Unies sur les contrats de vente internationale de marchandises) ne s’appliquent pas.
- Le client doit nous confirmer que sa commande ne viole pas les droits de tiers.
- Si nous avons fourni une garantie légale de conformité, l’acheteur ou le client n’est pas en droit de la faire valoir à la première requête. Une réclamation pour perte de bénéfices ne peut être introduite que suite et sur présentation de la sentence arbitrale correspondante.
- Si certaines dispositions du présent contrat conclu avec le client, y compris les présentes conditions de livraison et de paiement, devaient s’avérer partiellement ou totalement nulles et non avenues, cela n’affectera en rien la validité des autres dispositions. La disposition partiellement ou totalement nulle et non avenue devra être remplacée par une disposition dont l’objectif économique se rapproche le plus possible de celui de la disposition invalidée.

ROS®

ROS CHIMNEYS, S.L.U.

Pol. Ind. Parc Pla, C/ Esparver Cendrós, s/n
E-43810 El Pla de Santa Maria (Tarragona) - SPAIN
Tel. +34 977 63 17 09 · Fax +34 977 63 17 10
roschimneys@rostubos.com - www.rostubos.com



Válido a partir de 09/2018

Valid from 09/2018

Valide à partir du 09/2018

Salvo errores de imprenta, omisiones y modificaciones
Except for printing errors, omissions and modifications
Sous réserve d'erreurs d'impression, omissions et modifications

DISTRIBUIDOR | DISTRIBUTOR | *DISTRIBUTEUR* :

